



COME, FOLLOW ME

2025 DOCTRINE & COVENANTS TEEN & ADULT ACTIVITY WORKBOOK

COME, FOLLOW ME

2025 DOCTRINE & COVENANTS TEEN & ADULT ACTIVITY WORKBOOK



HONOR T. WRIGHT

ColorMeChristian.org

**FREE! Download this workbook
and much more!**



DISCLAIMER: While I have made every attempt to make this workbook reflect the teachings and values of the Come, Follow Me 2025 Lesson Manual and the teachings of the Church of Jesus Christ of Latter-day Saints, this workbook is not sponsored or endorsed by the Church and it does not officially represent the Church in any way.

Come, Follow Me is a resource offered by The Church of Jesus Christ of Latter-day Saints. It is designed to be used in the home to support personal and family scripture study to build faith in Heavenly Father and His plan of salvation and in the Savior Jesus Christ and His Atonement. Come, Follow Me is self-contained and adequate, when used properly. Products and materials designed to supplement this resource, though they may be helpful in some instances, are not necessary for a successful home study program.

CREDIT: The activities and images from Arie Van Der Graaff (<http://www.mormoncartoonist.com>) have been reproduced with his kind permission. Other graphics used in the mazes and search and find pages were purchased from SmartArtsForKids from (<https://www.etsy.com/shop/SmartArtsForKids>) and LittleFoxDigitals and Melonheadz on Etsy and used according to the license. The cover art, maze pictures, and patterns used in the word-based coloring pages were made with Midjourney. The coloring pages were made with Ideogram AI. All of the text in this workbook is a summary, paraphrase, or direct quote of the Come, Follow Me 2025 Lesson Manual. All of the scriptures are from the Doctrine and Covenants, Pearl of Great Price, KJV Bible or the Book of Mormon. The beautiful borders were obtained with the appropriate licenses from Catcarolines at www.teacherspayteachers.com/Store/Catcarolines.

Copyrighted material © 2024 All rights reserved. This book or any portion thereof may not be reproduced or used in any manner without the express written permission of the publisher and the other persons referenced in the credits above except for the use of brief quotations in a book review. You have the author's permission to make photocopies or prints for your family and church classes.

ISBN-979-8303454934

Published by ColorMeChristian
ColorMeChristian.org

December 30–January 5

The Restoration of the Fulness of the Gospel of Jesus Christ

“The Promised Restoration Goes Forward”

Word Search

Instructions: Find the bold words from the scripture in the word search puzzle. Each word could be hidden forwards, backwards, up, down, or diagonally.

Joseph Smith—History 1:13

At length I came to the conclusion that I must either **remain in darkness** and **confusion**, or else I must do as **James directs**, that is, **ask of God**. I at **length** came to the **determination** to “ask of God,” **concluding** that if he gave **wisdom** to them that **lacked** wisdom, and would **give liberally**, and not **upbraid**, I might **venture**.

J	U	H	K	Q	O	A	S	P	K	G	D	B	N	I
N	X	L	H	E	Y	T	Y	S	U	G	U	H	I	F
O	L	B	T	C	O	N	F	U	S	I	O	N	A	C
I	H	P	G	F	V	B	L	V	G	K	W	A	M	A
T	M	S	N	M	O	D	S	I	W	Q	R	R	E	Z
A	G	T	E	G	U	X	P	D	H	P	X	N	R	O
N	N	N	L	O	M	D	K	A	C	Y	Q	D	L	I
I	I	V	B	D	H	Z	X	R	B	E	U	I	I	C
M	D	I	R	E	C	T	S	K	S	X	S	A	B	F
R	U	C	P	D	P	G	D	N	S	H	E	R	E	E
E	L	V	E	N	T	U	R	E	R	H	M	B	R	Q
T	C	A	S	K	X	G	O	S	K	W	A	P	A	I
E	N	U	H	M	X	I	C	S	V	C	J	U	L	J
D	O	V	Q	J	Z	V	W	T	S	V	A	E	L	W
A	C	H	M	X	J	E	N	D	K	R	M	L	Y	R



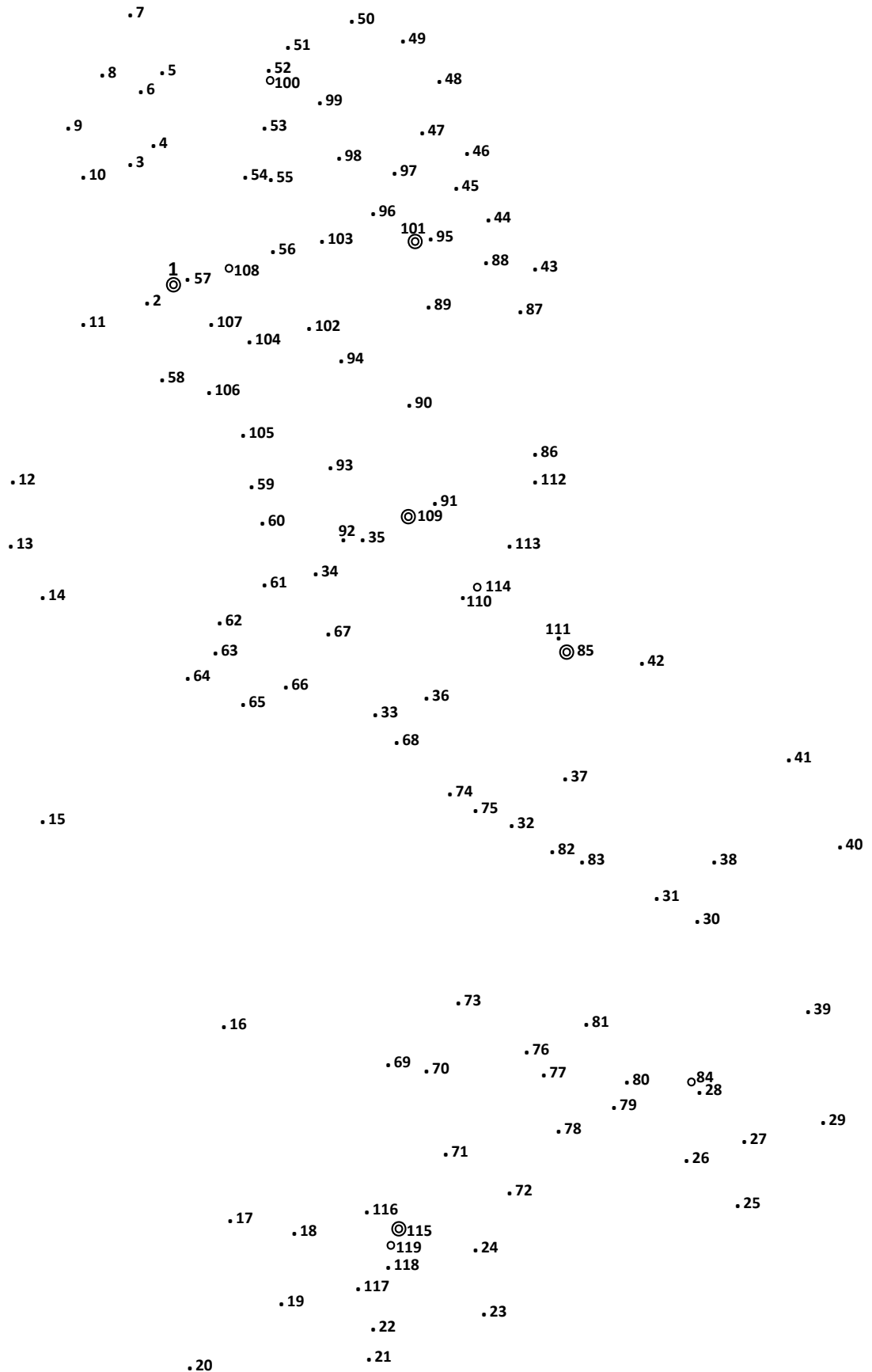

Key

- Stop. Pick up your pencil and go to the next dot.
- ◎ Start. Put your pencil down and draw the next line.

December 30–January 5

The Restoration of the Fulness of the Gospel of Jesus Christ

“The Promised Restoration Goes Forward”

Cryptogram

Instructions: Each letter on the top stands for a letter in the alphabet. Solve the encrypted phrase by matching each letter on top to a letter in the alphabet on the bottom. Use the key to help you remember what the letters stand for so you can crack the code.

S	K	B	Q	G	C	P	A	I	F	W	V	N	M	O	R	X	U	L	J	Z	H	Y	T	E	D
A	B	C	D	E	F	G	H	I	J	K	L	M	N	O	P	Q	R	S	T	U	V	W	X	Y	Z

Ī M̄ X̄ V̄ Ȳ N̄ Ī Z̄ Ā X̄ Ō J̄ X̄ V̄ Ī Ā K̄ H̄ P̄ Ō J̄
K̄ Ō P̄ Z̄ Ā H̄ M̄ Z̄ X̄ R̄ N̄ R̄ S̄ X̄ Ō J̄ Ō Ḡ Ī M̄ Ī Ō M̄ Ā ,
Ī Ō J̄ X̄ Ȳ M̄ Ā H̄ Ī Z̄ X̄ Ō N̄ W̄ Ā Ȳ S̄ J̄ : K̄ V̄ H̄ X̄ Ī Ā
X̄ Ō C̄ Ȳ Z̄ Ō M̄ Ȳ ? K̄ V̄ Ō Ō J̄ H̄ S̄ S̄ X̄ V̄ Ȳ Ā Ȳ
Ḡ H̄ P̄ X̄ Ī Ȳ Ā H̄ P̄ Ȳ P̄ Ī Ē V̄ X̄ ; Ō P̄ , H̄ P̄ Ȳ X̄ V̄ Ȳ W̄
H̄ S̄ S̄ K̄ P̄ Ō M̄ Ē X̄ Ō Ē Ȳ X̄ V̄ Ȳ P̄ ? Ī J̄ H̄ M̄ W̄ Ō M̄ Ȳ
Ō J̄ X̄ V̄ Ȳ N̄ C̄ Ȳ P̄ Ī Ē V̄ X̄ , K̄ V̄ Ī F̄ V̄ Ī Ā Ī X̄ ,
H̄ M̄ Z̄ V̄ Ō K̄ Ā V̄ H̄ S̄ S̄ Ī B̄ M̄ Ō K̄ Ī X̄ ?
T̄ Ō Ā Ȳ Ḡ V̄ Ā N̄ Ī X̄ V̄ - V̄ Ī Ā X̄ Ō P̄ W̄ 1 : 1 0

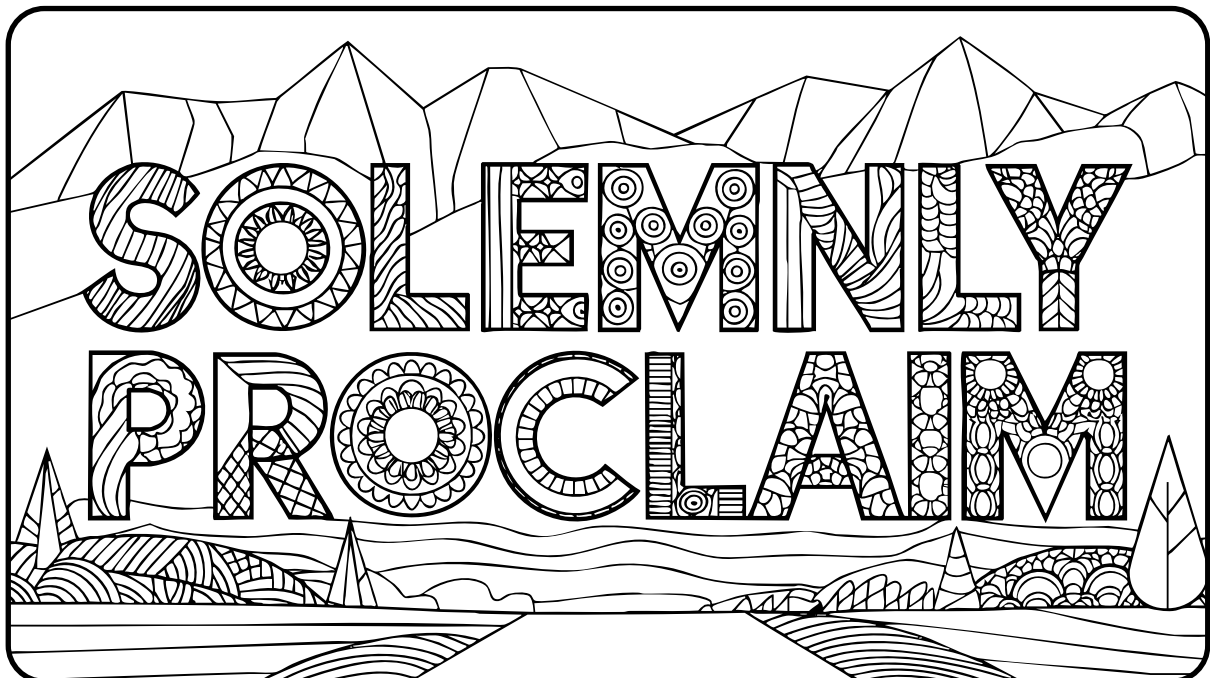

We solemnly proclaim that God loves His children in every nation of the world. (The Restoration Proclamation)

December 30—January 5

The Restoration of the Fulness of the Gospel of Jesus Christ

“The Promised Restoration Goes Forward”

The heavens are open.

Come, Follow Me 2025 Manual

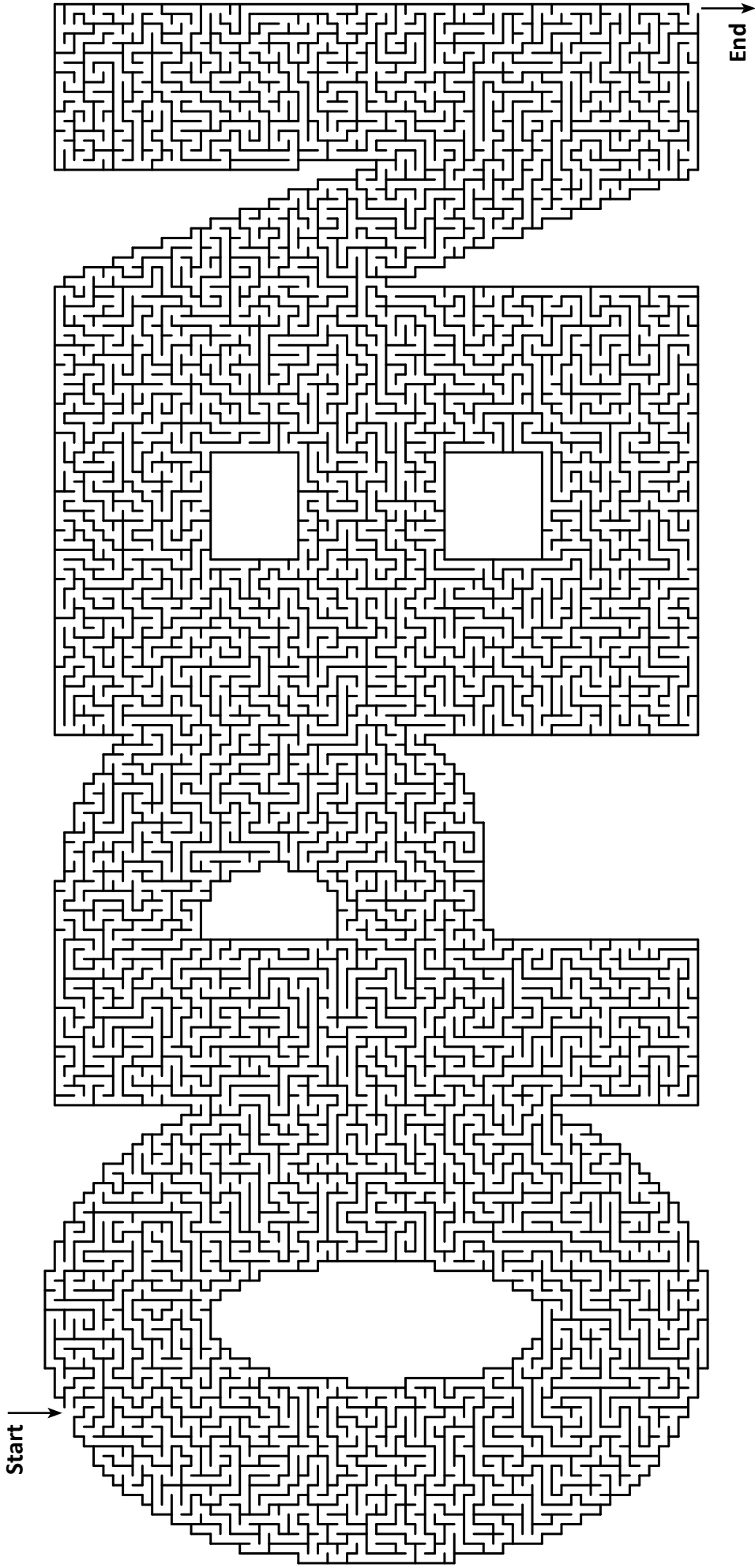

December 30–January 5

The Restoration of the Fulness of the Gospel of Jesus Christ

“The Promised Restoration Goes Forward”

Word Sudoku

Instructions: Solve this word sudoku puzzle the same way that you’d solve a numeric sudoku. Each of the bold words in the scripture below is found once in every row, column and 3×3 box.

Restoration Proclamation, Paragraph 4

We affirm that under the direction of the Father and the Son, heavenly messengers came to instruct Joseph and re-establish the **Church** of Jesus **Christ**. The resurrected John the Baptist restored the **authority** to **baptize** by immersion for the remission of sins. Three of the original twelve Apostles—Peter, James, and John—restored the **apostleship** and **keys** of **priesthood** authority. Others came as well, including Elijah, who restored the authority to join **families** together **forever** in eternal relationships that transcend death.

families		priesthood					keys	
keys			families	apostleship				forever
				priesthood	keys	baptize		families
				Christ	authority	forever	apostleship	
	keys		Church		apostleship	authority		
authority		apostleship		families			baptize	
		families			priesthood		authority	Church
	priesthood	authority			families	keys		
			forever	authority	Christ		priesthood	

December 30–January 5

The Restoration of the Fulness of the Gospel of Jesus Christ

“The Promised Restoration Goes Forward”

Instructions: Fit the bold words from the scripture below into the encircled squares. Words will read forward, backward, up, down, and diagonally and will normally cross other words. Start with the hints provided.

Restoration Proclamation, Paragraph 9

With **reverence** and **gratitude**, we as His **Apostles** invite all to know—as we do—that the **heavens** are **open**. We affirm that God is making **known** His **will** for His beloved **sons** and **daughters**. We **testify** that those who **prayerfully study** the message of the **Restoration** and act in **faith** will be blessed to gain their own **witness** of its **divinity** and of its **purpose** to **prepare** the **world** for the promised **Second Coming** of our Lord and Savior, **Jesus Christ**.

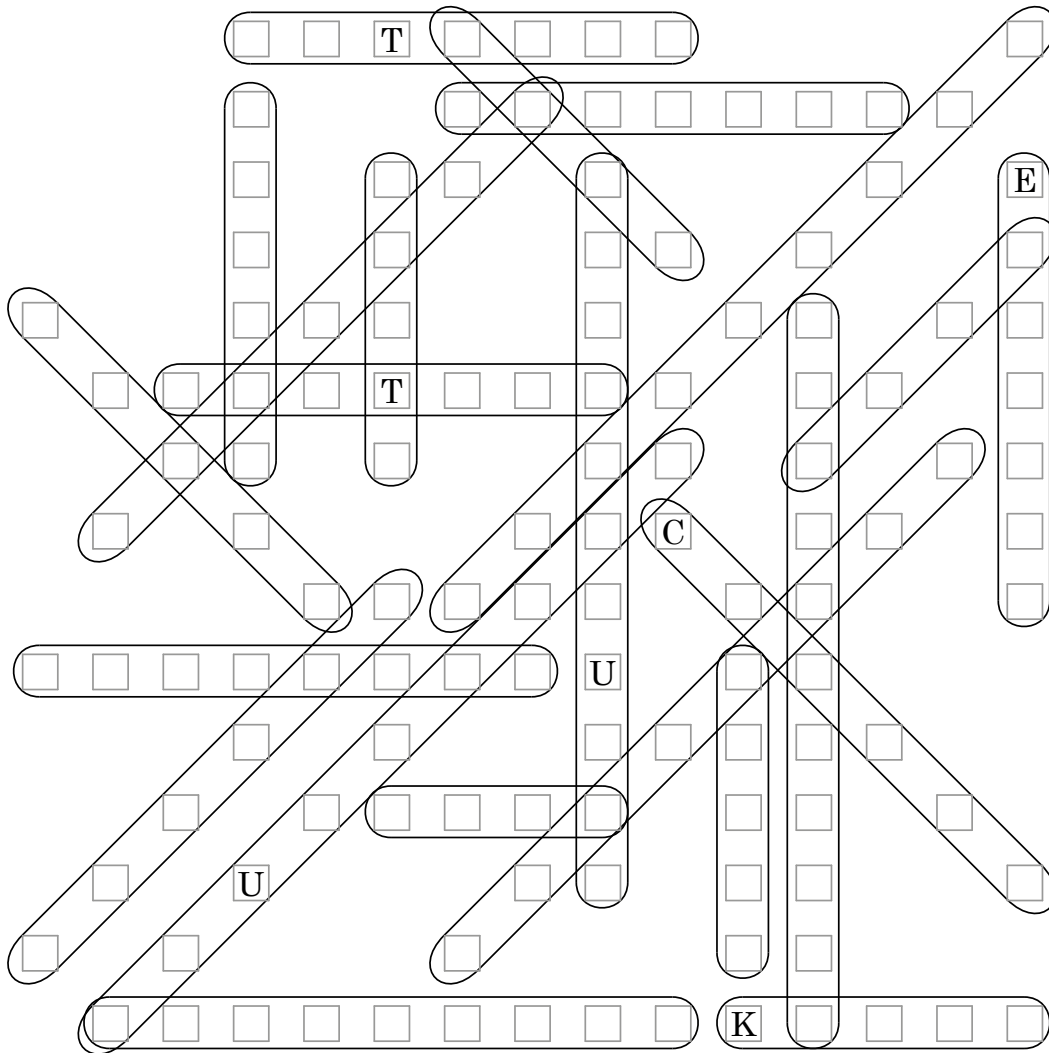

- | | | | | | |
|-------------|-----------|-----------|----------|-------------|---------|
| reverence | gratitude | Apostles | heavens | open | known |
| will | sons | daughters | testify | prayerfully | study |
| Restoration | faith | witness | divinity | purpose | prepare |
| world | Second | Coming | Christ | | |

January 6–12

Doctrine and Covenants 1

“Hearken, O Ye People”

Letter Sudoku

Instructions: Solve the letter sudoku puzzle the same way you’d solve a numeric sudoku. Check your puzzle against the answer key on ColorMeChristian.org. Every column, row, and group of nine must contain every letter in the word(s) **SPAKE UNTO**.

Doctrine and Covenants 1:17

Wherefore, I the Lord, knowing the calamity which should come upon the inhabitants of the earth, called upon my **servant** Joseph Smith, Jun., and **spake unto** him from heaven, and gave him commandments;

	O	A	E	K				N
T					N			
			S			U		
U			P			N		A
	N	P	U	S		O		T
O	E		T					
		T		A				U
S			N			P		
		N		P				S

Translation Station

Instructions: Translate the sign language letters below into English to discover the hidden message. Write the alphabet letter beneath each hand sign. Use the key at the back of the book to help you.



Mystery Picture Graph

Instructions: Find the mystery picture below by plotting and connecting the points of each line on the coordinate graph. Connect all the points in Line 1, stop, pick up your pencil, and then connect all the points in Line 2, and so on for the rest of the lines. The dots for the first 3 (X,Y) coordinate pairs on Line 1 have been placed for you.

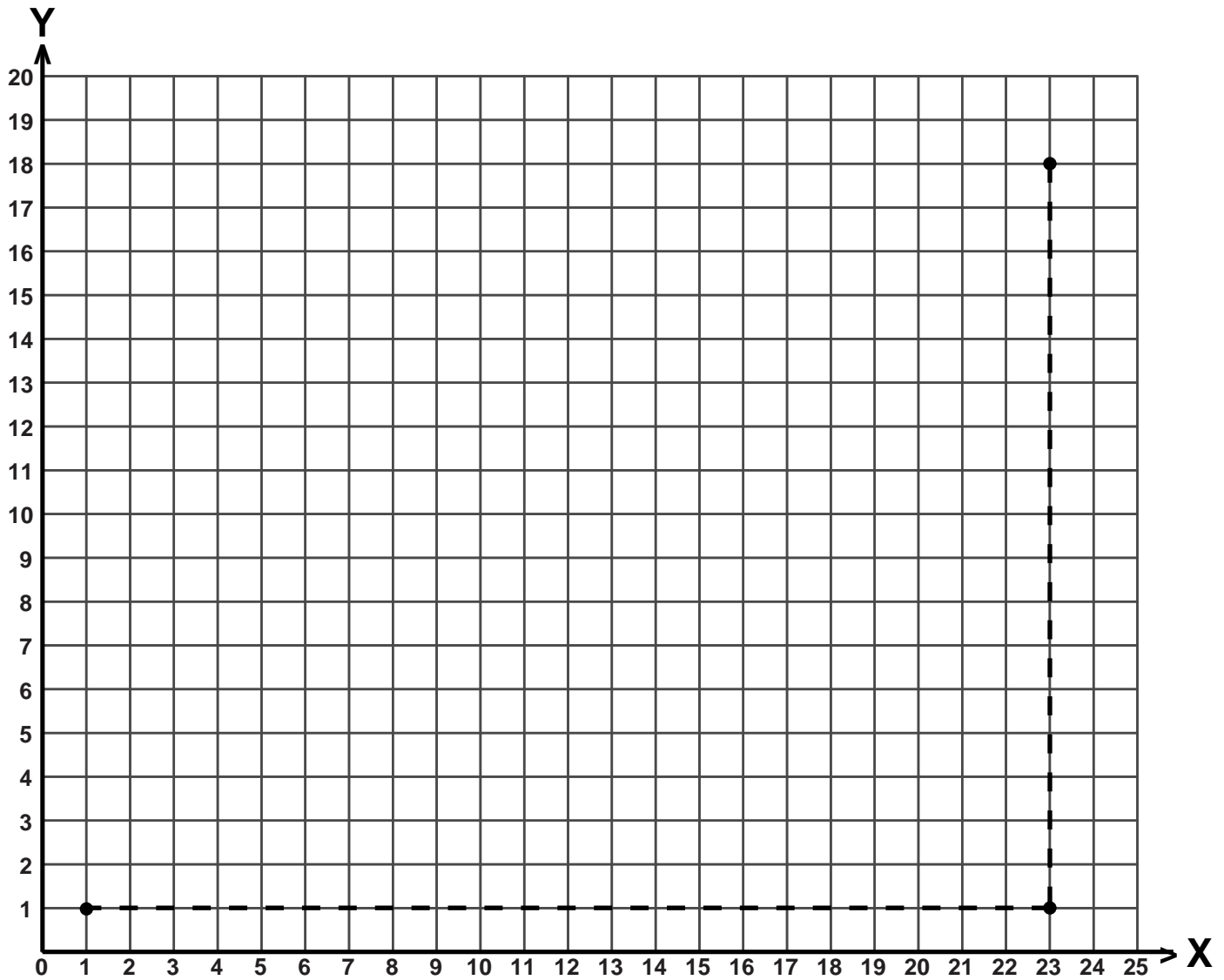

Line 1	(1, 1)	(23, 1)	(23, 18)	(1, 18)	(1, 1)	Line 2	(1, 3)	(23, 3)	Line 3	(2, 17)	(2, 4)	(22, 4)
(22, 17)	(2, 17)	Line 4	(6, 15)	(4, 13)	Line 5	(9, 15)	(4, 10)	Line 6	(17, 13)	(20, 16)	Line 7	(16, 10)
(20, 14)	Line 8	(18, 9)	(20, 11)	Line 9	(4, 4)	(5, 6)	(9, 8)	(10, 8)	(10, 9)	(9, 10)	(9, 12)	(10, 14)
(11, 15)	(13, 15)	(14, 14)	(15, 12)	(15, 10)	(14, 9)	(14, 8)	(18, 6)	(19, 4)	Line 10	(10, 8)	(11, 4)	Line 11
(9, 8)	(8, 6)	(9, 5)	(8, 4)	Line 12	(14, 8)	(15, 7)	(15, 4)	(13, 6)	(14, 7)	(15, 6)	Line 13	(14, 5)
(15, 5)	Line 14	(10, 8)	(12, 7)	(14, 8)	Line 15	(9, 11)	(10, 11)	(10, 14)	Line 16	(14, 14)	(14, 11)	(15, 11)
Line 17	(12, 11)	(12, 10)	Line 18	(10, 9)	(11, 8)	(13, 8)	(14, 9)	Line 19	(11, 9)	(13, 9)	Line 20	(11, 12)
(11, 11)	Line 21	(13, 12)	(13, 11)	Line 22	(11, 4)	(12, 7)	Line 23	(13, 4)	(12, 7)	Line 24	(2, 2)	(3, 3)
(4, 2)	(3, 1)	(2, 2)	Line 25	(20, 2)	(21, 3)	(22, 2)	(21, 1)	(20, 2)	Line 26	(19, 2)	(14, 2)	

January 6–12

Doctrine and Covenants 1

“Hearken, O Ye People”

mormoncartoonist.com

© Arie Van De Graaff



Handwriting Practice

Practice your handwriting by tracing the sentence below. Then use the blank lines to write the sentence on your own.

The Lord called Joseph Smith to be a prophet.

Blank handwriting practice lines for independent writing.

January 6–12

Doctrine and Covenants 1

“Hearken, O Ye People”

Missing Vowels Word Search

Instructions: Find the hidden words. The words have been placed horizontally, vertically, diagonally, forwards, or backwards, and the vowels have been removed. When you locate a word, draw an ellipse around it and fill the vowels in. The first word, **heavens**, has been done for you.

Doctrine and Covenants 1:37–39

Search these **commandments**, for they are **true** and **faithful**, and the **prophecies** and **promises** which are in them shall all be **fulfilled**. What I the Lord have **spoken**, I have spoken, and I **excuse not myself**; and though the **heavens** and the **earth pass away**, my **word** shall not pass away, but shall all be fulfilled, whether by mine own **voice** or by the voice of my **servants**, it is the **same**. For behold, and lo, the Lord is God, and the Spirit beareth record, and the **record** is **true**, and the truth abideth **forever** and ever. Amen.



Fill in the Blank

Doctrine and Covenants 1:30

And also those to whom these _____ were given, might have _____ to lay the _____ of this _____, and to bring it _____ out of _____ and out of _____, the only _____ and _____ church upon the _____ of the whole _____, with which I, the _____, am well _____, speaking unto the _____ collectively and not _____

- | | | | | | |
|--------|---------|--------------|--------------|------------|-----------|
| church | power | darkness | earth | Lord | obscurity |
| forth | church | individually | commandments | foundation | true |
| living | pleased | face | | | |

January 6–12

Doctrine and Covenants 1

“Hearken, O Ye People”

Instructions: Fill in the blank puzzle grid using the word bank with the bold words from the scripture below. Place the words in the correct place on the grid.

Doctrine and Covenants 1:29

And **after** having **received** the **record** of the **Nephites**, yea, even my **servant Joseph Smith**, Jun., might have **power** to **translate through** the **mercy** of **God**, by the **power** of God, the **Book of Mormon**.

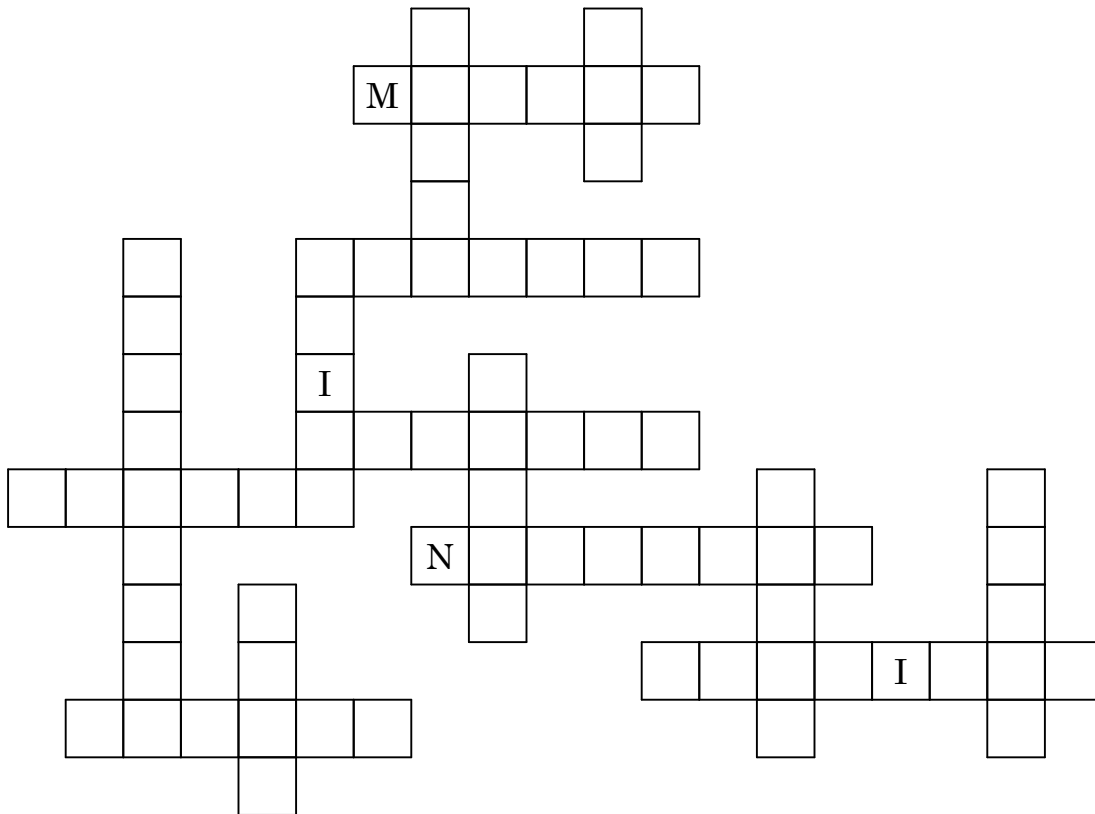

3 Letters

God

4 Letters

Book

5 Letters

power

Smith

mercy

power

after

6 Letters

Mormon

Joseph

record

7 Letters

through

servant

8 Letters

Nephites

received

9 Letters

translate

January 13–19

Joseph Smith—History 1:1–26

“I Saw a Pillar of Light”

Reverse Word Search

Instructions: Instead of looking for words in a grid, place the bold words in the scripture in the empty word search puzzle. The words may be forwards, backwards, up, down, or diagonally. The start letter of the words have been placed in the grid to get you started. The first word, **KNOW** has been done for you.

Joseph Smith—History 1:12

Never did any **passage** of scripture come with more **power** to the **heart** of man than this did at this time to mine. It seemed to **enter** with great **force** into every **feeling** of my heart. I **reflected** on it **again** and again, knowing that if any person needed **wisdom** from God, I did; for how to act I did not know, and unless I could get more **wisdom** than I then had, I would **never know**; for the **teachers** of **religion** of the different sects **understood** the same passages of scripture so **differently** as to **destroy** all **confidence** in settling the **question** by an **appeal** to the **Bible**.

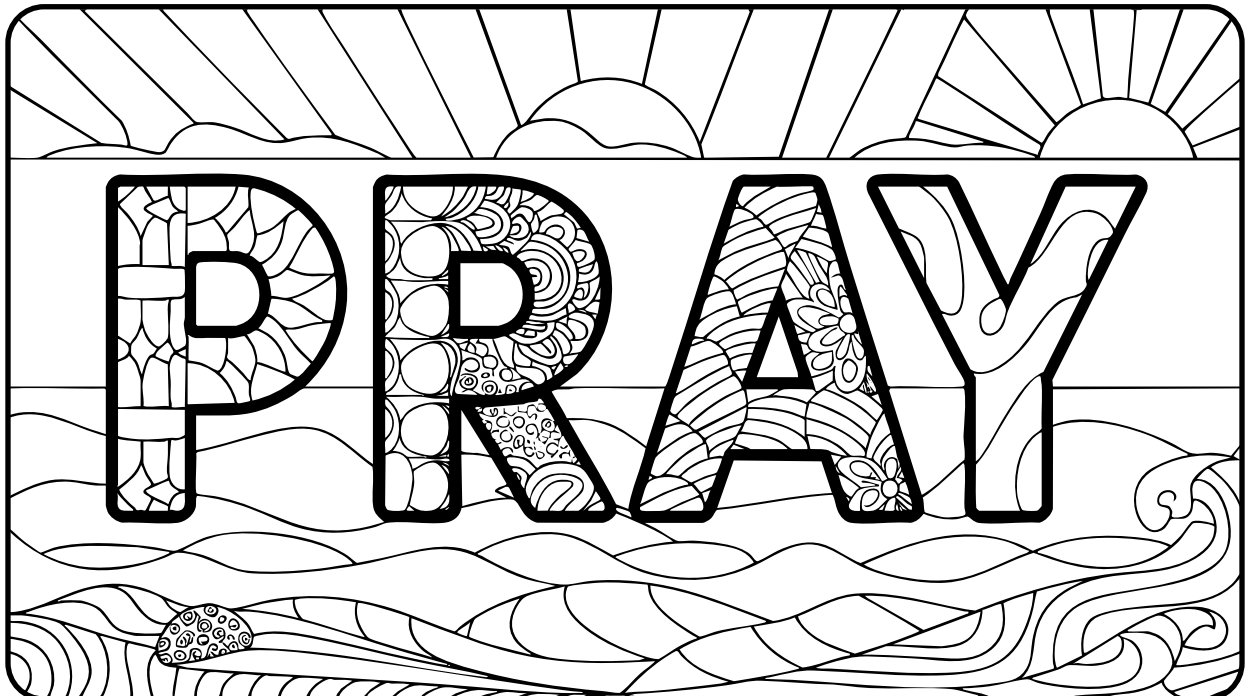
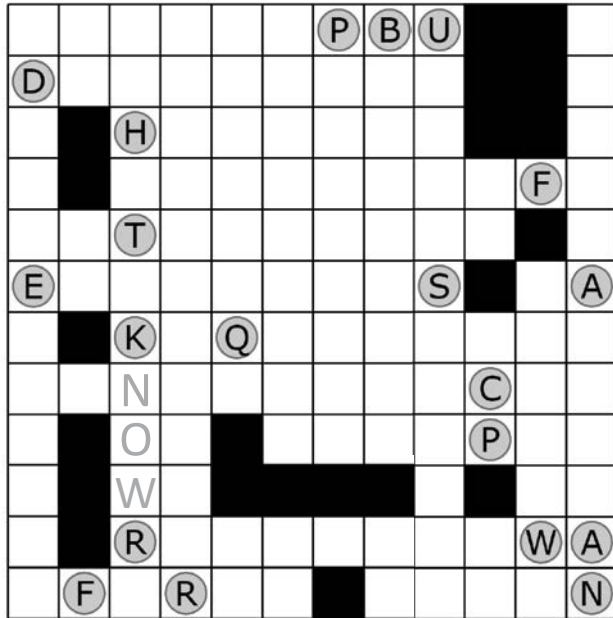

Heavenly Father hears and answers my prayers.

January 13–19

Joseph Smith—History 1:1–26

“I Saw a Pillar of Light”

Wacky Word Trails

Instructions: Start with the circled letter, use the clues to find and mark the trail of letters of all the connected bolded words from the scripture through the maze to the last letter. The path can wander up, down, left, and right at any point, even in the middle of the word.

Joseph Smith—History 1:16

But, exerting all my **powers** to call upon **God** to **deliver** me out of the power of this **enemy** which had **seized** upon me, and at the very **moment** when I was ready to **sink** into **despair** and **abandon** myself to **destruction**—not to an imaginary ruin, but to the power of some **actual being** from the **unseen** world, who had such marvelous power as I had never before felt in any being—just at this moment of **great alarm**, I saw a **pillar of light** exactly **over** my **head**, above the **brightness** of the **sun**, which **descended gradually** until it fell upon me.

Q	P	Y	Q	M	U	G	H	T	A	L	A	R	M	P
E	D	U	Z	E	Y	I	L	E	X	B	W	K	H	O
D	P	I	M	R	G	U	T	C	P	S	Z	R	E	W
N	E	L	L	A	R	E	A	I	D	C	A	S	J	F
A	C	S	I	S	E	S	L	A	U	T	E	S	J	C
D	D	E	H	G	E	N	U	F	E	Z	I	F	H	T
O	G	R	T	I	N	D	B	W	I	E	I	U	F	F
I	V	E	N	R	B	A	I	S	S	D	O	V	T	X
L	E	S	E	S	S	D	N	N	U	Q	Y	E	Q	J
X	D	Y	I	P	S	E	K	E	N	E	M	R	B	G
A	L	L	I	A	D	Q	H	V	H	H	T	I	E	L
U	D	H	R	G	N	D	U	W	Z	T	V	N	O	Q
R	A	E	A	B	A	O	E	K	Y	U	M	G	H	X
G	U	A	D	U	R	N	D	C	C	P	O	H	I	R
N	O	I	T	C	T	S	E	C	Z	F	M	E	N	T

Word Star

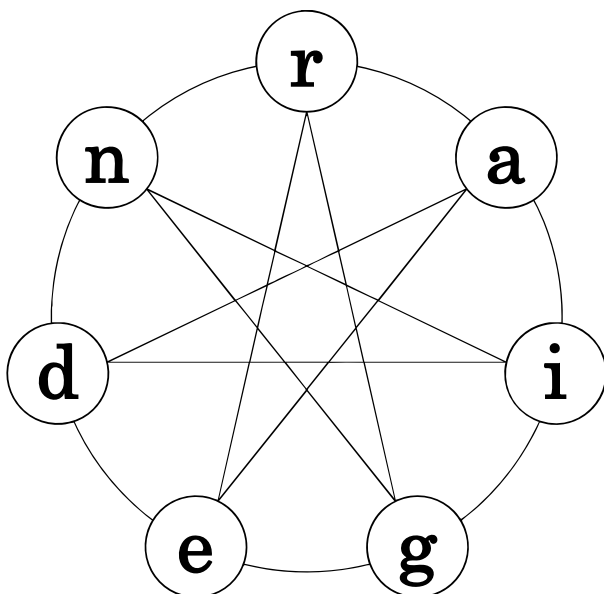

Instructions: Only one route through the word star will make a word. Try each letter and follow the pathway through the star to see if it makes a word.. IF you need a hint, look at the words in the scripture below. Write the letters of the word you discover in the blanks below as you travel through the star:

— — — — —

Now can you find this word in the following scripture?

Joseph Smith—History 1:11



Key

○ Stop. Pick up your pencil and go to the next dot.

⊙ Start. Put your pencil down and draw the next line.

January 13–19

Joseph Smith—History 1:1–26

“I Saw a Pillar of Light”

Instructions: Connect all of the letters in the maze and then write the phrase in the blanks below. Don't be tricked by letters that take you into a dead end! There is only one path through the maze.

-----,-----
-----,
-----.

Search, Ponder and Pray, Children's Songbook

Start

Finish

O	T	E	T	O	R	E	A	D	T	H	C	R	I	P	R	U	S	D	N	A	N
L	O	V	I	T	S	E	S	T	H	Y	S	C	R	I	P	T	E	R	A	S	A
I	L	O	M	O	T	T	T	I	E	L	Y	S	C	R	I	P	T	U	R	E	S
T	E	V	O	N	Y	A	T	O	H	O	L	Y	S	C	R	T	U	R	D	N	A
R	R	H	A	H	T	T	R	A	E	H	N	I	N	M	I	U	R	E	E	D	N
U	Y	T	T	T	O	G	R	O	Y	M	H	M	Y	H	E	E	S	A	E	D	
E	E	H	T	R	T	G	R	O	W	W	I	T	I	F	E	F	E	M	Y	R	E
I	T	S	T	A	R	T	T	W	T	I	T	H	O	D	O	I	F	I	R	E	V
R	I	P	S	E	H	T	L	E	E	F	I	O	D	I	E	M	I	T	Y	R	E
I	R	I	P	S	P	H	E	S	P	E	E	I	O	D	I	E	I	I	T	Y	R
T	I	R	I	P	S	E	S	R	I	E	L	F	I	F	D	O	I	M	I	T	Y
S	T	I	R	I	R	S	P	I	R	L	T	E	F	E	E	I	F	D	I	E	T
T	S	T	I	R	I	R	I	R	I	T	H	E	E	E	L	F	E	I	E	M	I
A	R	S	T	I	T	I	R	I	T	H	E	S	R	L	T	I	O	D	I	E	M
R	T	T	S	T	S	T	A	T	S	E	S	P	I	R	I	F	I	O	D	O	E
O	T	A	T	S	T	A	R	S	T	S	P	I	R	I	T	E	F	I	O	D	I
G	O	R	A	T	A	R	T	T	I	P	I	R	I	T	S	R	E	E	I	O	D
R	G	T	R	A	R	T	T	O	R	I	R	I	T	S	T	A	E	L	F	I	O
O	O	T	T	R	T	T	O	G	R	T	I	T	S	T	A	R	T	T	E	F	I
W	G	O	T	T	T	O	G	R	O	S	T	S	T	A	R	T	T	O	E	E	F
W	R	G	O	T	O	G	R	O	W	W	I	T	A	R	T	T	O	G	L	E	E
I	O	R	G	O	G	R	O	W	W	I	R	A	R	T	T	O	G	R	T	L	E
T	W	O	W	O	R	O	W	W	I	T	T	R	T	T	O	G	W	O	W	T	L
H	W	I	W	I	O	W	W	I	T	H	T	T	T	O	G	R	W	I	E	H	T
I	H	T	H	T	W	W	I	M	N	I	O	T	R	G	W	O	I	P	S	E	H
N	I	H	I	H	W	I	T	H	M	N	W	W	O	W	W	W	I	P	S	E	H
M	N	I	H	T	I	T	H	I	Y	T	I	W	W	W	I	T	H	I	P	S	E

January 20–26

Doctrine and Covenants 2; Joseph Smith—History 1:27–65

“The Hearts of the Children Shall Turn to Their Fathers”

Word Spiral

Instructions: Fill in the blank puzzle grid using the bold words from the scripture or phrase below. *The bold words may not all be used!* Use the letter hint below and count the letters of the bold words to figure out where each word goes. Then transfer the letters that have little numbers in their box to the hidden word at the bottom of the puzzle. Check the answer on ColorMeChristian.org.

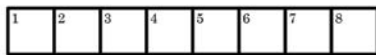
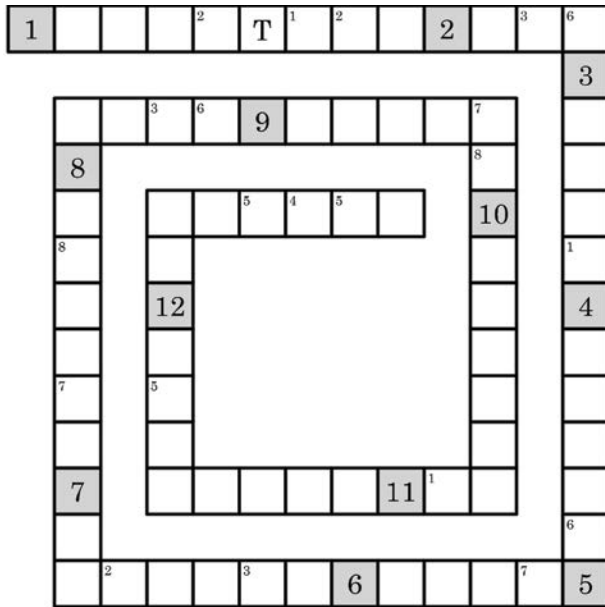

**Families Can Be Together Forever,
Children’s Songbook**

Families can be **together forever**
Through Heavenly Father’s plan. I
always want to be **with** my own **family,**
And the **Lord** has **shown** me how I **can.**
The Lord has shown me how I can.

Knight Moves - Find a Word

Instructions: Start with any letter in the puzzle to see if it’s the beginning of a word. To get to the next letter, jump two squares in any direction except diagonally, and then one square in a different direction. To show you how it works, I’ve included numbers on this first puzzle to show you how to solve it. Your path will look like a capital L. Only one route through the puzzle will make a word. Write the letters of the word you discover in the blanks below as you jump through the squares:

1 2 3 4 5 6 7 8

Now can you find this word in the following scripture?

Doctrine and Covenants 2:2

s 8	i 5	r 2
o 3		e 7
s 6	p 1	m 4

Hidden Picture: Heavenly Father wants families to be sealed in the temple. Can you find the 5 temples in the hidden picture below? It will be tricky; the temples may be smaller, on their side, or even upside down! Then, see if you can find one copy of the animals as well.

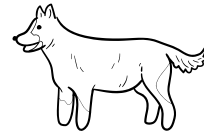

January 20–26

Doctrine and Covenants 2; Joseph Smith—History 1:27–65

“The Hearts of the Children Shall Turn to Their Fathers”

Word Angles

Instructions: Find the bold words from the scripture. Each word path may run north, east, south, or west, may make one right-angled turn, and may cross another word path. A few words may make no right angle turn at all.

Joseph Smith—History 1:29

In consequence of these things, I often felt **condemned** for my **weakness** and **imperfections**; when, on the evening of the above-mentioned twenty-first of September, after I had **retired** to my bed for the **night**, I betook myself to **prayer** and **supplication** to **Almighty** God for **forgiveness** of all my **sins** and **follies**, and also for a **manifestation** to me, that I might **know** of my **state** and **standing** **before** him; for I had full **confidence** in obtaining a **divine** manifestation, as I previously had one.

A	N	D	I	N	G	U	Y	N	O	I	T	A	T	S	E
T	S	B	S	U	P	P	L	A	K	N	E	S	S	E	L
S	W	C	F	D	W	E	I	E	I	N	N	S	E	F	Q
U	R	K	R	M	B	C	C	W	K	R	X	J	A	I	S
V	I	G	R	O	F	N	A	W	R	L	Z	P	L	N	A
E	I	A	K	T	K	E	T	R	K	A	Z	Y	M	A	Q
N	J	D	O	L	N	D	I	F	N	O	C	Y	I	M	U
E	M	E	F	M	O	W	O	M	H	Y	T	H	G	X	T
S	B	D	B	E	D	G	N	N	S	W	T	N	F	S	S
S	U	X	C	T	S	H	J	E	C	T	I	O	N	S	N
D	N	O	C	A	E	D	S	F	D	O	K	A	B	S	I
E	O	I	S	T	I	E	X	R	I	U	B	F	E	H	T
M	C	F	O	L	L	R	N	E	V	B	C	Q	F	R	N
N	I	W	R	E	T	I	N	P	I	N	E	R	O	S	L
E	Y	M	J	B	G	G	I	M	A	O	E	Y	A	R	P
D	B	Y	C	T	T	H	G	I	S	N	R	S	N	V	E

Unscrambler

Instructions: Unscramble the words below; look at the bold words in the scripture for a hint.

Joseph Smith—History 1:34

He said there was a **book deposited**, written upon **gold plates**, giving an **account** of the **former inhabitants** of this **continent**, and the source from whence they sprang. He also said that the **fulness** of the everlasting **Gospel** was contained in it, as **delivered** by the **Savior** to the ancient inhabitants;

visaro _____

bkoo _____

ogld _____

ogpesl _____

hnibtatnasi _____

liedeedvr _____

tdpisedeo _____

mrfoer _____

lfussen _____

unctoca _____

eastlp _____

cnnteoint _____

January 20–26

Doctrine and Covenants 2; Joseph Smith — History 1:27–65

“The Hearts of the Children Shall Turn to Their Fathers”

Learning about my ancestors can bring me joy.

Come, Follow Me 2025 Manual

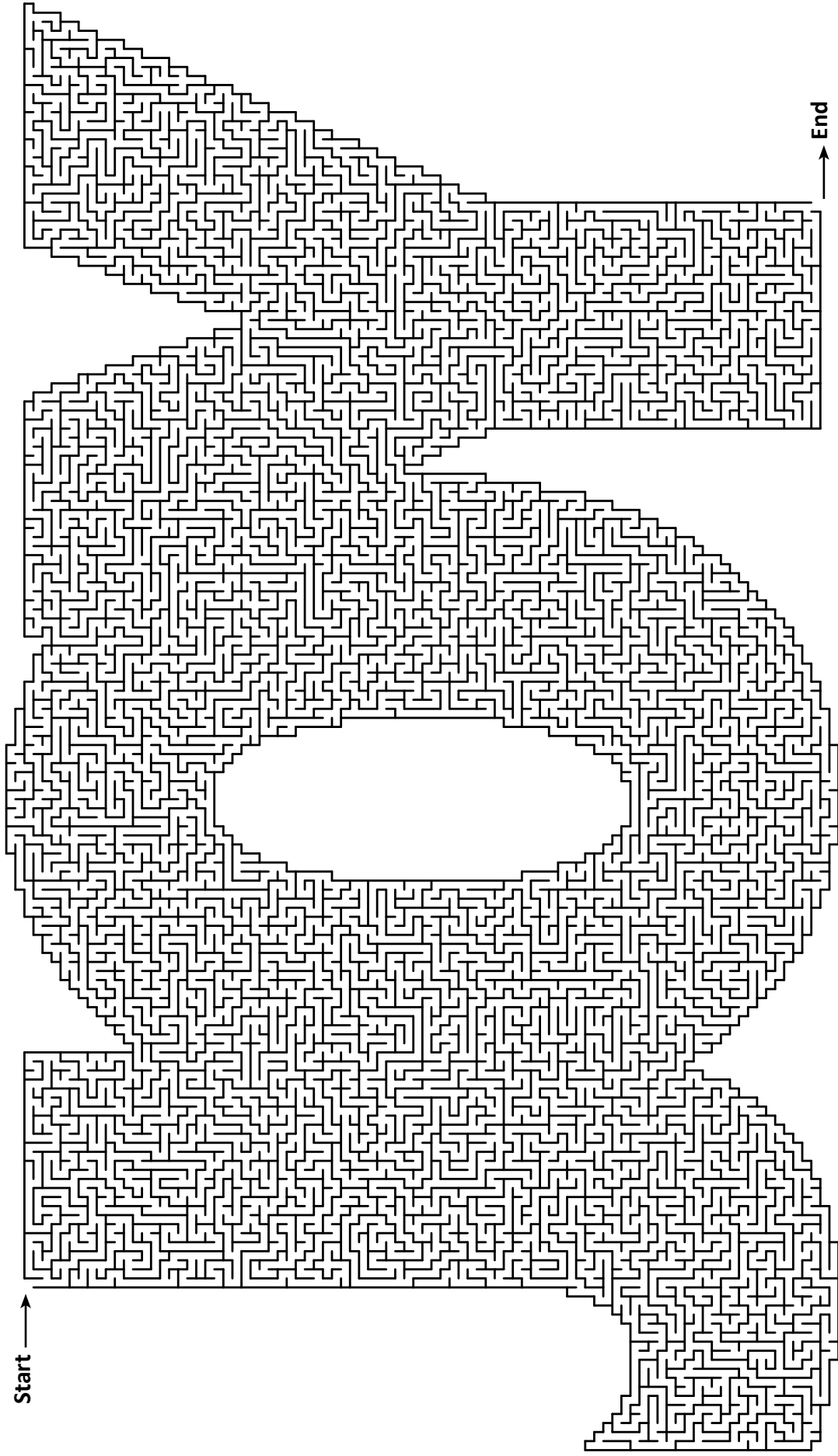

January 20–26

Doctrine and Covenants 2; Joseph Smith—History 1:27–65

“The Hearts of the Children Shall Turn to Their Fathers”



Handwriting Practice

Practice your handwriting by tracing the sentence below. Then use the blank lines to write the sentence on your own.

I can repent and be forgiven.

I can repent and be forgiven.

Blank handwriting practice lines consisting of a solid top line, a dashed middle line, and a solid bottom line.

January 27–February 2

Doctrine and Covenants 3–5

“My Work Shall Go Forth”

Translation Station

Instructions: Translate the Morse code below into English to discover the hidden message. Write the alphabet letter beneath each Morse Code letter. Each letter, number, and punctuation is separated by a slash: /. Use the key at the back of the book to help you.

-. / - - - - / . - - - / - . . . / . / / - - - - / . - . . / - . . / - - - - - - /
-. / - - - / . - - / . - . / . . - - / . / . - . . / - - - - / . . - / . . . /
. - - - / - - - - / . - . / - . - / . . / . . . / . - / - . . . / - - - - / . . - / - - /
- / - - - - / - . . . / - - - - / - - - / . / / - - - - / . - . / - / /
. - / - - - / - - - - / - . / - - - - / - / / . /
- . - . / / . . / . - . . / - . . / . - . / . / - / - - - - / . . - . /
- - / . / - . / . - . - - - / - . . / - - - - / - . - . / - / . - . / . . / - . / . /
-. / - . / - . . / - . - . / - - - - / . . - - / . / - . / . - / - . / - / . . . /
. . . - / - - - - . . . / . - - - - - /



I can be a witness that the Book of Mormon is true.

January 27–February 2

Doctrine and Covenants 3–5

“My Work Shall Go Forth”

Word Search

Instructions: Find the bold words from the scripture in the word search puzzle. Each word could be hidden forwards, backwards, up, down, or diagonally.

Doctrine and Covenants 3:7–8

For, behold, you should not have **feared man** more than **God**. Although men set at **naught** the **counsels** of God, and **despise** his **words**—Yet you **should** have been **faithful**; and he would have **extended** his **arm** and **supported** you against all the **fiery darts** of the **adversary**; and he would have been **with** you in **every time** of **trouble**.

Y	T	R	O	U	B	L	E	Y	D	R	C	N	D	D
S	P	Y	R	A	S	R	E	V	D	A	G	A	E	E
X	E	U	O	Y	Z	E	S	D	R	O	W	U	D	S
G	C	B	Q	G	R	M	Y	H	M	Z	K	G	N	P
K	W	E	F	A	I	I	I	Z	Z	Y	R	H	E	I
Z	K	H	X	A	J	T	G	J	J	R	H	T	T	S
F	Y	W	W	S	M	D	M	R	A	E	J	G	X	E
H	T	I	W	K	J	J	U	N	N	V	G	N	E	G
S	U	P	P	O	R	T	E	D	X	E	D	R	O	H
D	Y	Y	E	I	G	S	U	S	G	M	A	D	I	R
E	F	A	I	T	H	F	U	L	A	Y	R	D	R	E
R	M	Z	H	M	O	E	Y	N	T	O	T	H	Q	P
A	T	K	T	V	J	S	C	O	U	N	S	E	L	S
E	C	J	F	I	E	R	Y	S	H	O	U	L	D	H
F	T	O	Q	A	S	L	D	X	S	L	G	D	J	A

Word Guess

Instructions: Write your word guesses in the puzzle below. For extra hints, look at the words/phrases in the scripture below. Check the answer on ColorMeChristian.org

	H								
	I								
	N			R					H
					T				
	M		A						
	E	V			E				

Doctrine and Covenants 4:2

Therefore, O ye that embark in the service of God, see that ye serve him with all your heart, might, mind and strength, that ye may stand blameless before God at the last day.

Helping the Lord with His Work

These children want to help the Lord with His work. Can you help them find the family at the end of the maze that wants to be taught the gospel?

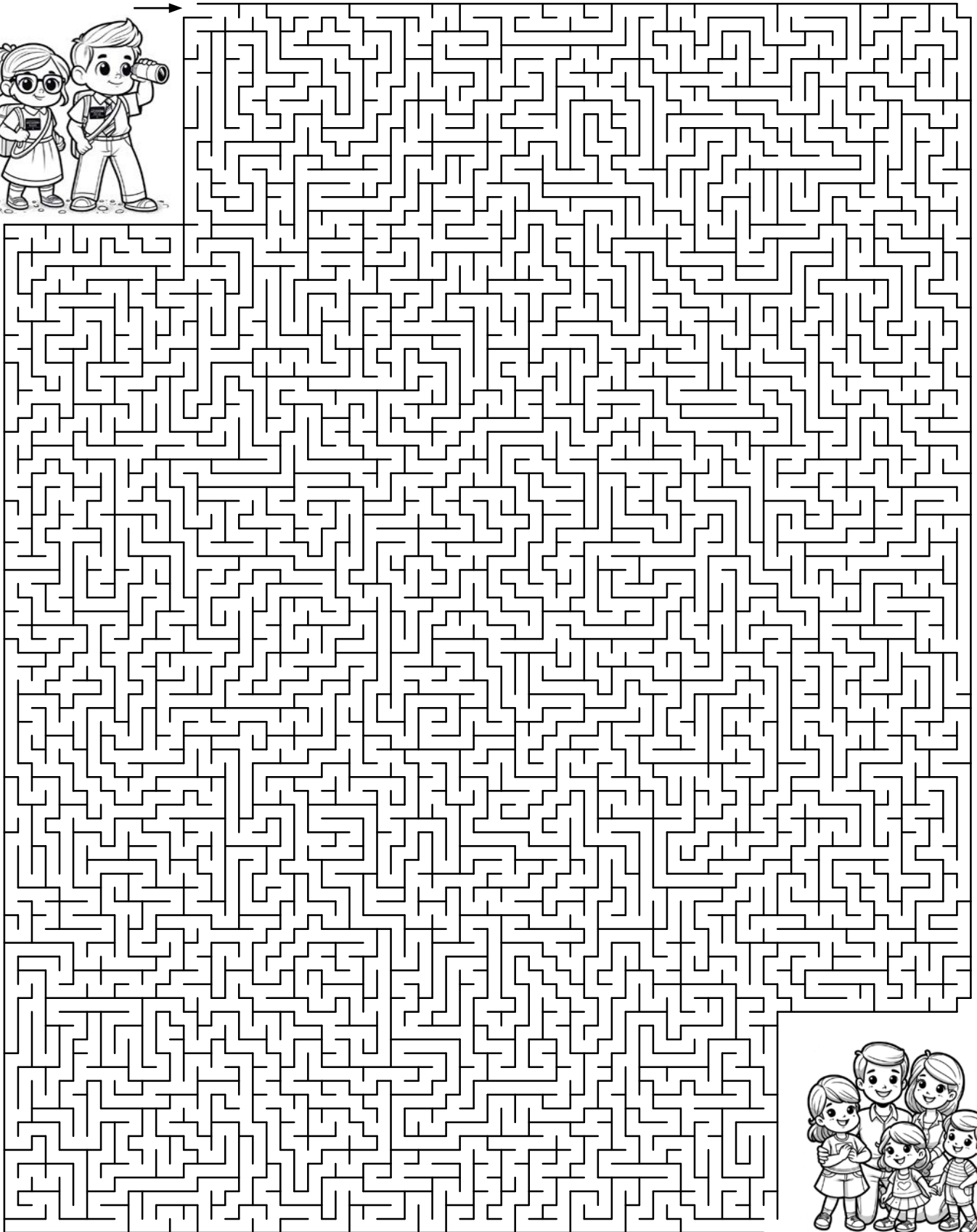

January 27–February 2

Doctrine and Covenants 3–5

“My Work Shall Go Forth”

Word Sudoku

Instructions: Solve this word sudoku puzzle the same way that you’d solve a numeric sudoku. Each of the bold words in the scripture below is found once in every row, column and 3×3 box.

Doctrine and Covenants 4:4-6

For behold the field is white already to harvest; and lo, he that thrusteth in his sickle with his might, the same layeth up in store that he perisheth not, but bringeth salvation to his soul; And **faith, hope, charity** and **love**, with an **eye single** to the **glory** of God, **qualify** him for the **work**. Remember faith, virtue, knowledge, temperance, patience, brotherly kindness, godliness, charity, humility, diligence.

charity						faith	eye	
		love	work	hope	single			
			eye			hope	work	
work		charity			glory			eye
			faith			charity	single	
glory		faith			eye			work
			qualify	eye			glory	
				work	hope	eye	love	
eye				charity	love	single		

January 27–February 2

Doctrine and Covenants 3–5

“My Work Shall Go Forth”

wardcartoonist.com

©Arie Van De Graaff



Handwriting Practice

Practice your handwriting by tracing the sentence below. Then use the blank lines to write the sentence on your own.

*The Lord invites me to help
with His work.*

Blank handwriting practice lines for independent practice.

January 27–February 2

Doctrine and Covenants 3–5

“My Work Shall Go Forth”

Instructions: Using the Across and Down clues, write the correct words in the numbered grid below. Hint: all of the words in the crossword come from the scripture below.

Doctrine and Covenants 3:5–10

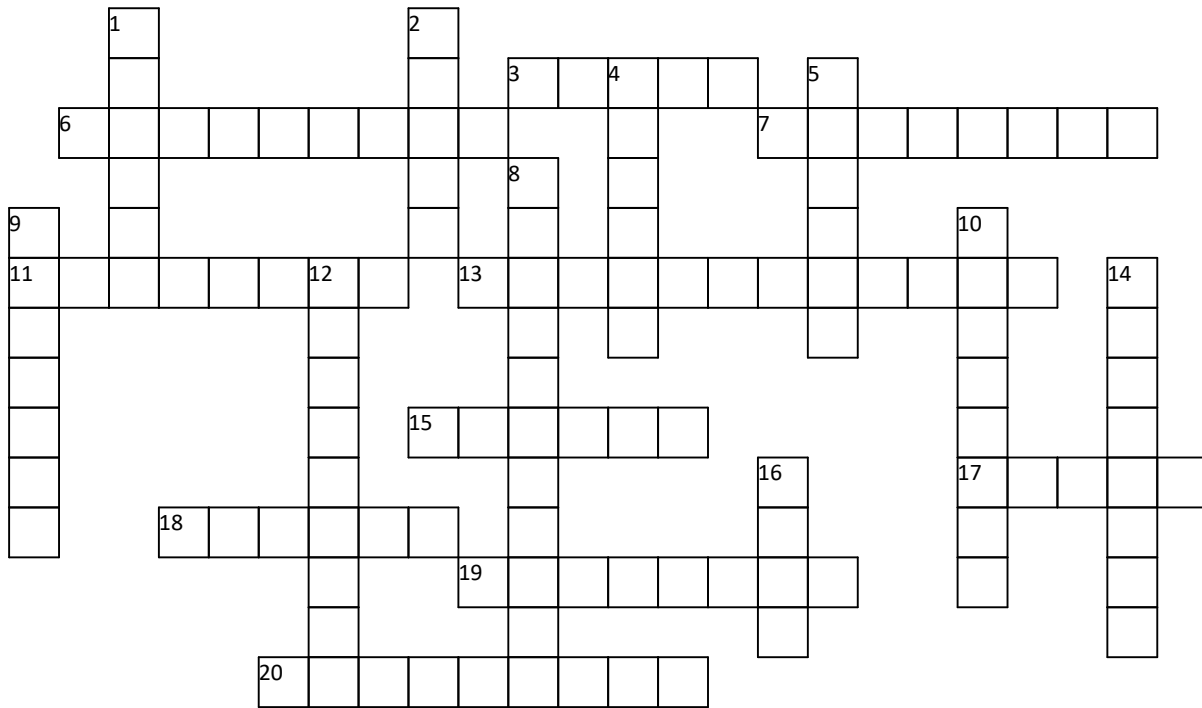

ACROSS

3. a small missile or spear
6. the act of bearing the weight of or strengthening
7. some who shows confidence and trust in Jesus Christ
11. to stretch out
13. infringement or violation of a law, command, or duty
15. an unpleasant often strong emotion caused by anticipation or awareness of danger
17. like or suggestive of a flame
18. those selected by God for special responsibilities
19. something that provides direction or advice
20. someone who offers opposition; another name for Satan

DOWN

1. nothing
2. each; all times or instances are included
4. that a person turns away from evil and turns his heart and will to God
5. receive an appointment or invitation from Him or His duly authorized Church leaders to serve Him in a particular way
8. arguments or entreaties to sway someone to a belief, position, or course of action
9. look down on with disdain or disgust
10. someone who has the spirit of compassion, tenderness, and forgiveness
12. put into the care or protection of someone
14. in direct opposition to
16. fail; move oneself to a lower position

February 3–9

Doctrine and Covenants 6–9

“This Is the Spirit of Revelation”



Therefore, fear not, little flock; do good; let earth and hell combine against you, for if ye are built upon my rock, they cannot prevail.

Doctrine and Covenants 6:34

February 3–9

Doctrine and Covenants 6–9

“This Is the Spirit of Revelation”

Instructions: Fit the bold words from the scripture below into the encircled squares. Words will read forward, backward, up, down, and diagonally and will normally cross other words. Start with the hints provided.

Doctrine and Covenants 9:7–9

Behold, you have not **understood**; you have **supposed** that I would **give** it unto you, when you took no **thought** save it was to **ask** me. But, behold, I say unto you, that you must **study** it out in your **mind**; then you must ask me if it be **right**, and if it is right I will cause that your **bosom** shall **burn** within you; therefore, you shall **feel** that it is right. But if it be not right you shall have no such feelings, but you shall have a **stupor** of **thought** that shall cause you to **forget** the **thing** which is **wrong**; therefore, you cannot **write** that which is **sacred** save it be **given** you from me.

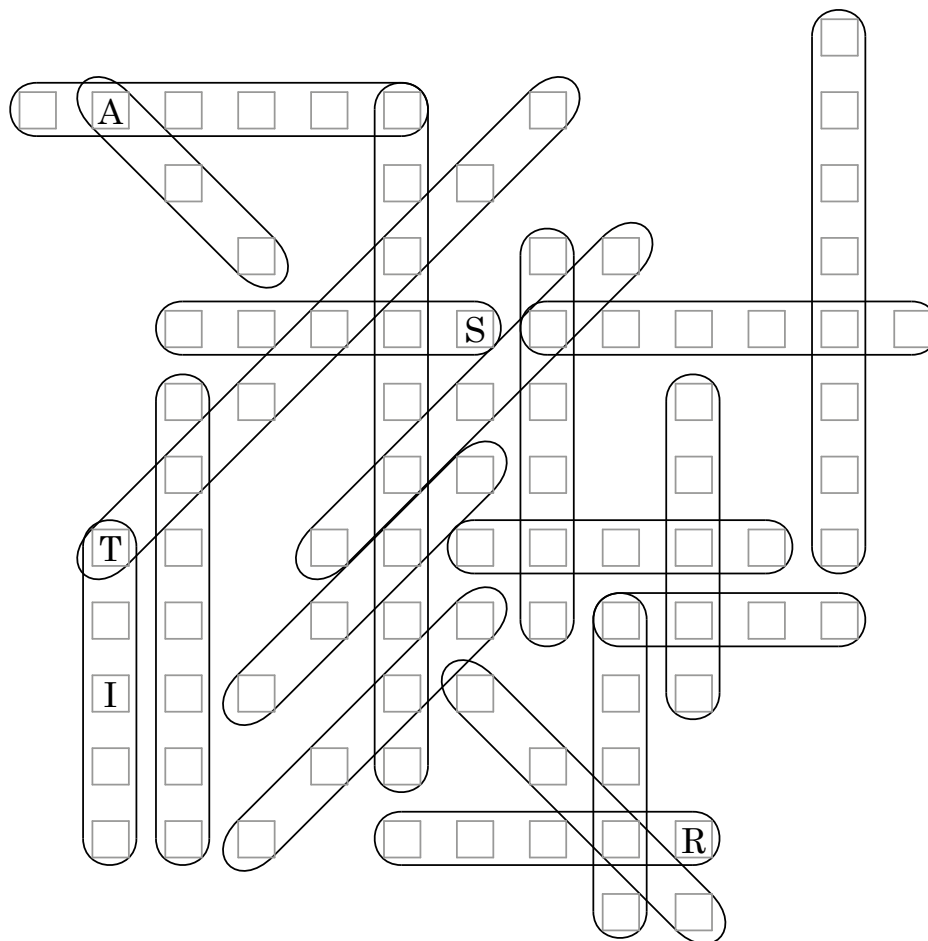

understood	supposed	give	thought	ask	study
mind	right	bosom	burn	feel	stupor
thought	forget	thing	wrong	write	sacred
given					

February 3–9

Doctrine and Covenants 6–9

“This Is the Spirit of Revelation”

Letter Sudoku

Instructions: Solve the letter sudoku puzzle the same way you’d solve a numeric sudoku. Check your puzzle against the answer key on ColorMeChristian.org. Every column, row, and group of nine must contain every letter in the word(s) **I FEAR NOT**.

Come, Follow Me 2025 Manual

Because of Jesus Christ, I can “fear not.”

F		A		I	T	N	
	O			F	R		
			O	E	A		
	A	R	N			F	
	E	N					
			F	N		E	R
	N		R	A	E	I	F

Translation Station

Instructions: Translate the sign language letters below into English to discover the hidden message. Write the alphabet letter beneath each hand sign. Use the key at the back of the book to help you.



February 3–9

Doctrine and Covenants 6–9

“This Is the Spirit of Revelation”

Instructions: Connect all of the letters in the maze and then write the phrase in the blanks below. Don't be tricked by letters that take you into a dead end! There is only one path through the maze.

Doctrine and Covenants 8:2

Start

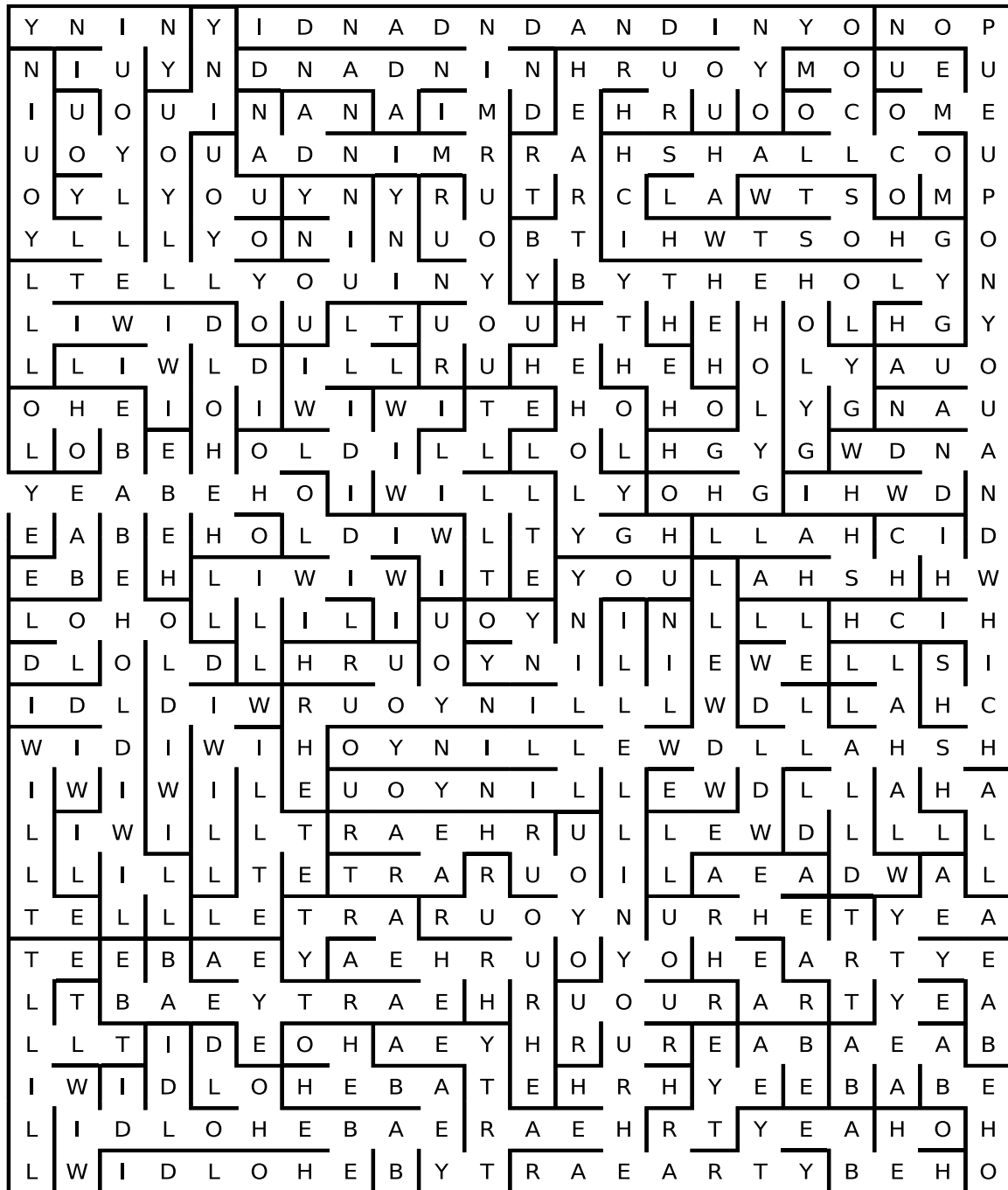

Finish

February 3–9

Doctrine and Covenants 6–9

“This Is the Spirit of Revelation”

wardcartoonist.com

SINCE IT'S NOT A BURNING
BOSOM, A STILL SMALL VOICE, OR
A STUPOR OF THOUGHT, I'M
GUESSING MY QUEASY STOMACH
ISN'T COMING FROM THE
SPIRIT.

©Arie Van De Graaff

Arie
VanDeGraaff

Handwriting Practice

Practice your handwriting by tracing the sentence below. Then use the blank lines to write the sentence on your own.

*I can look to Jesus Christ in
every thought.*

Blank handwriting practice lines for independent practice.

February 3–9

Doctrine and Covenants 6–9

“This Is the Spirit of Revelation”

Missing Vowels Word Search

Instructions: Find the hidden words. The words have been placed horizontally, vertically, diagonally, forwards, or backwards, and the vowels have been removed. When you locate a word, draw an ellipse around it and fill the vowels in.

Doctrine and Covenants 6:22–23

Verily, verily, I say unto you, if you **desire** a **further witness**, cast your **mind** upon the **night** that you **cried** unto me in your **heart**, that you might **know** concerning the **truth** of these **things**. Did I not **speak** **peace** to your **mind** concerning the **matter**? What **greater** witness can you have than **from God**?

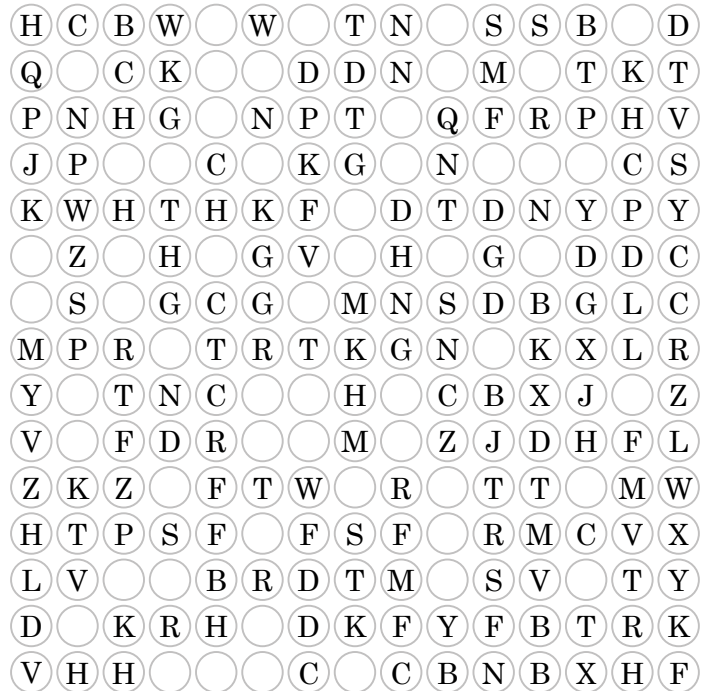

Fill in the Blank

Doctrine and Covenants 6:15–16

Behold, thou _____ that thou hast _____ of me and I did _____ thy
_____; and now I _____ thee these _____ that thou mayest know that
_____ hast been enlightened by the _____ of _____; Yea, I tell
_____, that thou mayest know that there is _____ else save _____ that
_____ thy _____ and the _____ of thy _____.

God	tell	none	knowest	truth	Spirit
mind	intents	things	heart	thou	knowest
enlighten	inquired	thee	thoughts		

February 10–16

Doctrine and Covenants 10–11

“That You May Come Off Conqueror”

Wacky Word Trails

Instructions: Start with the circled letter, use the clues to find and mark the trail of letters of all the connected bolded words from the scripture through the maze to the last letter. The path can wander up, down, left, and right at any point, even in the middle of the word.

Doctrine and Covenants 11:21, 26

Seek not to **declare** my word, but **first seek** to **obtain** my word, and **then** shall your **tongue** be **loosed**; then, if you **desire**, you shall have my **Spirit** and my word, yea, the **power** of God unto the **convincing** of **men**. Therefore, **treasure** up in your **heart** until the **time** which is in my **wisdom** that you shall go **forth**.

Q R W N A L O F N J W U V Z W
S N J P R D O S E D E H F Z C
H L H I O W N E I F C W P T F
Y E B A Q V T H R S T M Y V C
W S H S E E K O D X N O A P K
R N O E Q O P M S I T N K L F
S D G U E W Q U C W H T R O F
P X N O R V V S X O D I N G G
L D C T M J Z O U T N V C I N
E H B N E H E B R J O C E N I
A T I P S N I M F J G U R F S
R I R M C P A S Z S S S H R W
T N H C N Q T **B** E C E A D K X
D E S L Y B I O D L R T P B X
N H I R E T I M E A R E N F R

Word Star

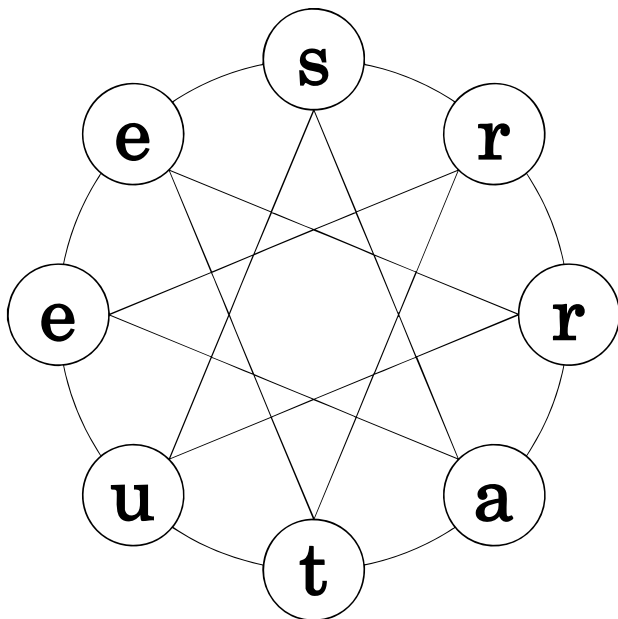

Instructions: Only one route through the word star will make a word. Try each letter and follow the pathway through the star to see if it makes a word.. IF you need a hint, look at the words in the scripture below. Write the letters of the word you discover in the blanks below as you travel through the star:

Now can you find this word in the following scripture?

Doctrine and Covenants 11:26

Hidden Picture: As you pray always, you receive strength from God. Can you find the 3 pictures of each of the praying children in the hidden picture below? It will be tricky; the children may be smaller, on their side, or even upside down! Then, see if you can find one copy of the animals as well.

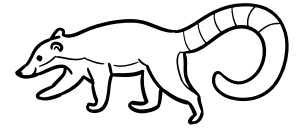
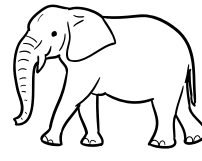
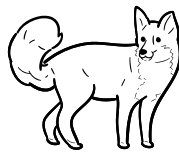

February 10–16

Doctrine and Covenants 10–11

“That You May Come Off Conqueror”

Instructions: Fill in the blank puzzle grid using the word bank with the bold words from the scripture below. Place the words in the correct place on the grid.

Doctrine and Covenants 11:12–13

And now, verily, verily, I say unto thee, **put** your **trust** in that **Spirit** which **leadeth** to do **good**—yea, to do **justly**, to **walk humbly**, to **judge righteously**; and this is my Spirit. Verily, verily, I say unto you, I will **impart** unto you of my Spirit, which shall **enlighten** your **mind**, which shall **fill** your **soul** with **joy**;

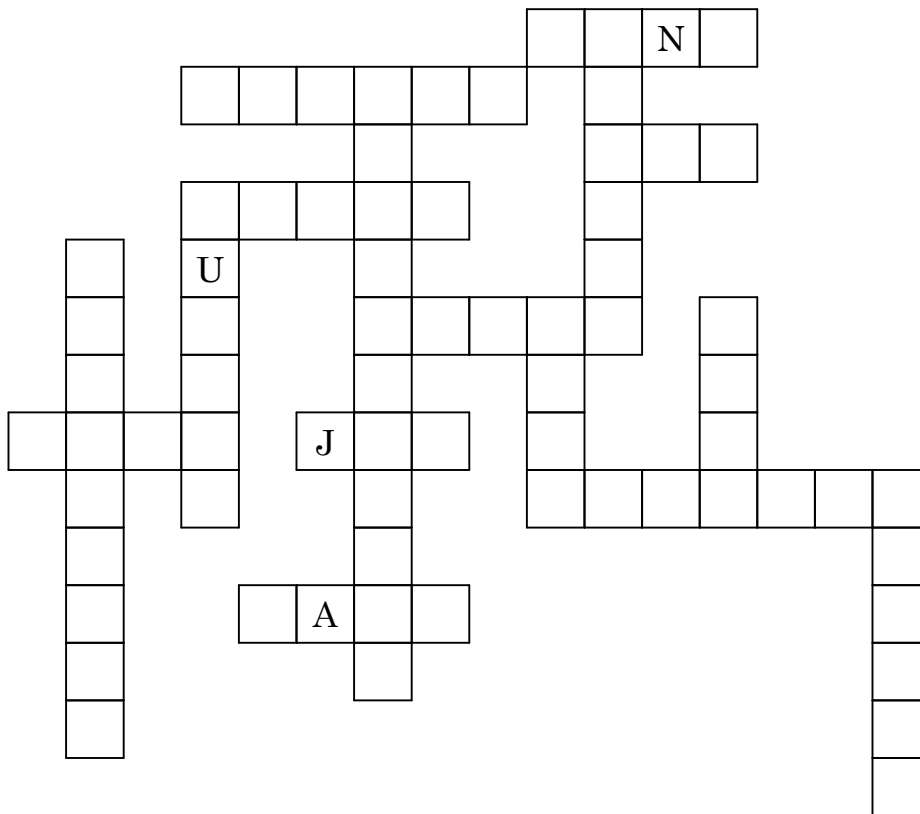

3 Letters

joy
put

4 Letters

walk
soul

fill

mind
good

5 Letters

judge
trust

6 Letters

justly
impart
Spirit
humbly

7 Letters

leadeth

9 Letters

enlighten

11 Letters

righteously

February 10–16

Doctrine and Covenants 10–11

“That You May Come Off Conqueror”

Cryptogram

Instructions: Each letter on the top stands for a letter in the alphabet. Solve the encrypted phrase by matching each letter on top to a letter in the alphabet on the bottom. Use the key to help you remember what the letters stand for so you can crack the code.

B	Q	X	L	O	Y	P	A	U	F	V	R	T	C	G	Z	J	H	I	N	K	M	D	S	E	W
A	B	C	D	E	F	G	H	I	J	K	L	M	N	O	P	Q	R	S	T	U	V	W	X	Y	Z

" X E V Y X H F M R H M R Y H K Y T S X J H L
 H Z H F , A I M S J Y Y D S M N D E X Y
 H L E I T W V Y H X S G L H F . " H
 N R S D W ' X G L H F Y L , N R S D W L Y T ' X
 X E T O A E E U



PRAY

ALWAYS



As I pray always, I receive strength from God.

Come, Follow Me 2025 Manual

February 10–16

Doctrine and Covenants 10–11

“That You May Come Off Conqueror”

The Holy Ghost leads me to do good.

Come, Follow Me 2025 Manual

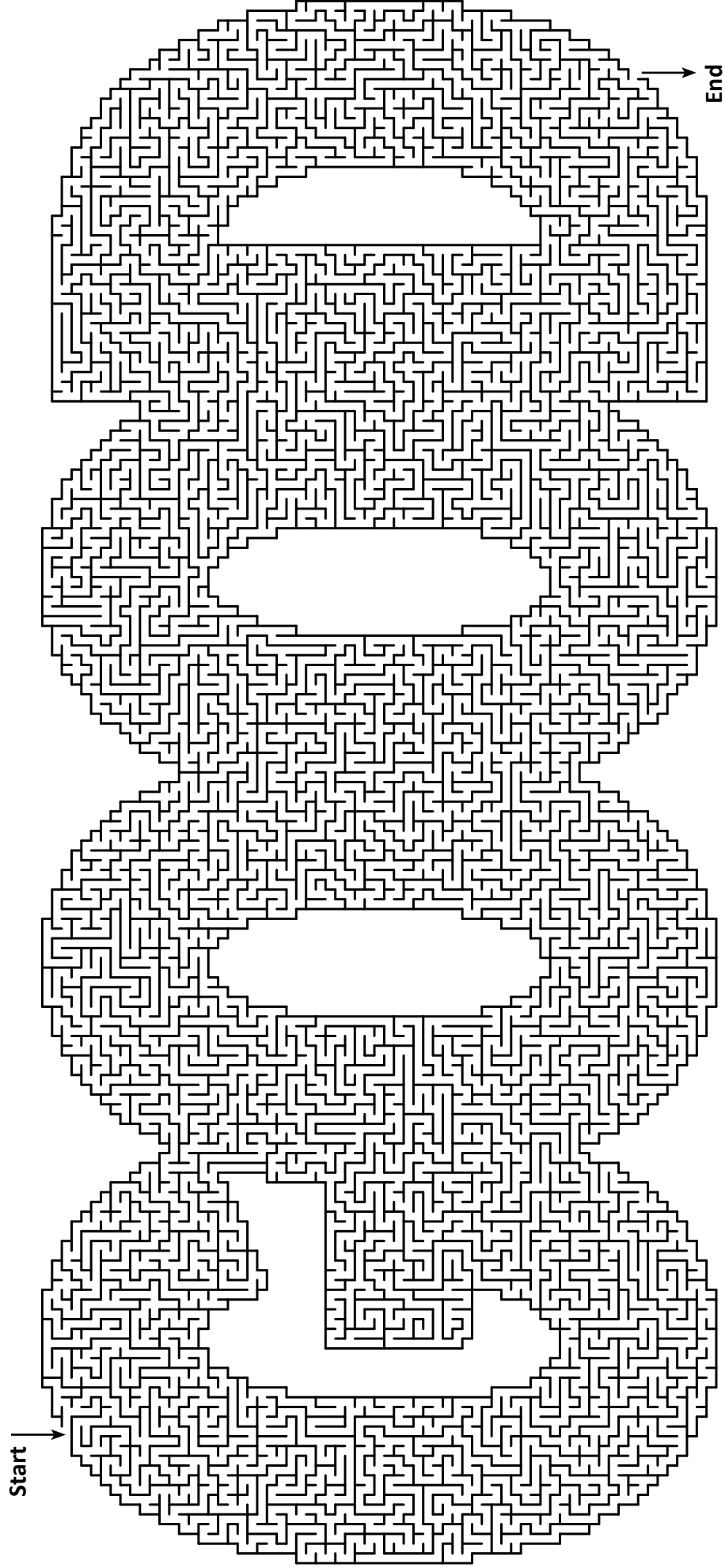

February 10–16

Doctrine and Covenants 10–11

“That You May Come Off Conqueror”



Word Square

Instructions: Word squares are a liike Sudoku puzzles, but each letter can occur only once in each row and in each column. Check your puzzle against the answer key on ColorMeChristian.org. Every row and column must contain every letter in the word **CONQUER**. This word can be written in the gray row.

Doctrine and Covenants 10:5

Pray always, that you may come off conqueror; yea, that you may **conquer** Satan, and that you may escape the hands of the servants of Satan that do uphold his work.

	Q	E			R	O
	U		Q	C		E
		U	O			
	R		E			U
				Q	E	
	C				Q	R
	O		C	E	U	N

February 17–23

Doctrine and Covenants 12–17; Joseph Smith—History 1:66–75

“Upon You My Fellow Servants”

Word Angles

Instructions: Find the bold words from the scripture. Each word path may run north, east, south, or west, may make one right-angled turn, and may cross another word path. A few words may make no right angle turn at all.

Doctrine and Covenants 17:5–6

And ye shall **testify** that you have **seen them**, even as my **servant Joseph Smith**, Jun., has seen them; for it is by my **power** that he has seen them, and it is because he had **faith**. And he has **translated** the **book**, even that **part** which I have **commanded** him, and as your **Lord** and your God **liveth** it is **true**.

U	O	K	W	E	T	Y	A	X	P	P	H	P	P	H	W
V	S	S	X	V	O	F	V	H	B	O	B	E	A	R	T
Y	B	M	N	O	B	I	X	J	S	G	H	M	X	Q	R
E	J	I	T	H	N	T	S	E	T	Y	O	K	S	E	U
Z	Y	P	B	F	D	I	F	E	X	O	O	P	T	A	J
S	F	S	M	J	N	T	N	R	X	X	B	B	P	J	V
G	R	F	H	I	A	I	P	D	O	X	V	J	F	W	T
L	D	Q	N	M	V	N	Y	Y	R	A	P	E	H	A	S
A	S	Q	U	M	R	Z	M	S	G	G	K	H	T	L	G
D	E	I	W	C	E	D	R	X	D	M	T	E	K	B	X
N	E	I	H	S	S	N	L	O	R	H	T	M	E	H	C
W	W	F	R	O	S	W	G	S	H	W	K	C	D	D	A
G	U	H	E	Q	L	I	V	E	T	V	X	O	E	L	M
J	N	P	W	O	P	H	T	I	A	F	Y	M	T	P	P
X	E	E	S	O	J	R	D	E	D	N	A	M	A	U	E
Z	M	F	D	D	H	L	R	T	R	A	N	S	L	N	K

Unscrambler

Instructions: Unscramble the words below; look at the bold words in the scripture for a hint.

Joseph Smith—History 1:70

He said this **Aaronic Priesthood** had not the **power** of **laying on hands** for the **gift** of the **Holy Ghost**, but that this should be **conferred** on us hereafter; and he **commanded** us to go and be baptized, and gave us **directions** that I should baptize Oliver **Cowdery**, and that afterwards he should baptize me.

ndrcisoeti _____

cernefod _____

drycweo _____

figt _____

eprwo _____

nsdah _____

oaaircn _____

isdrhootep _____

shtog _____

olyh _____

ngilay _____

mndcaodme _____

February 17–23

Doctrine and Covenants 12–17; Joseph Smith—History 1:66–75

“Upon You My Fellow Servants”

Reverse Word Search

Instructions: Instead of looking for words in a grid, place the bold words in the scripture in the empty word search puzzle. The words may be forwards, backwards, up, down, or diagonally. The start letter of the words have been placed in the grid to get you started.

Doctrine and Covenants 13:1

Upon you my **fellow servants**, in the name of **Messiah** I confer the **Priesthood of Aaron**, which holds the **keys** of the **ministering** of angels, and of the **gospel** of **repentance**, and of **baptism** by **immersion** for the **remission** of sins; and this shall **never** be **taken** **again** from the **earth**, until the sons of Levi do offer again an offering unto the Lord in righteousness.

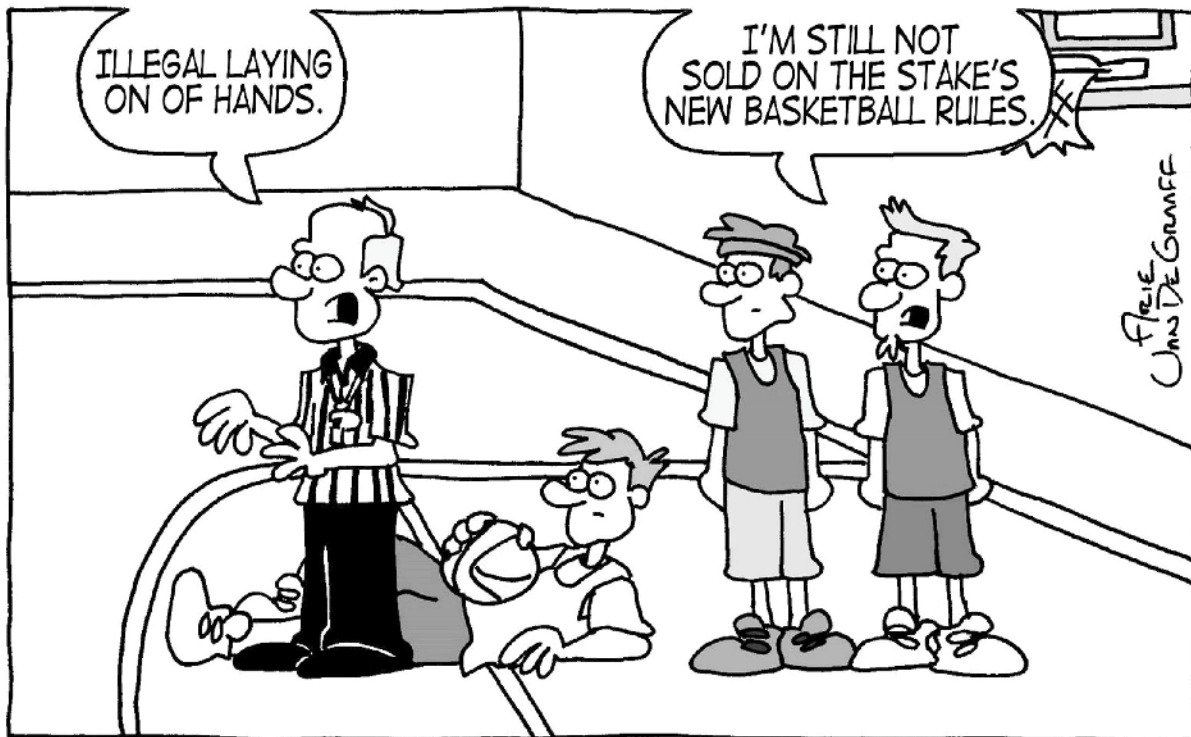
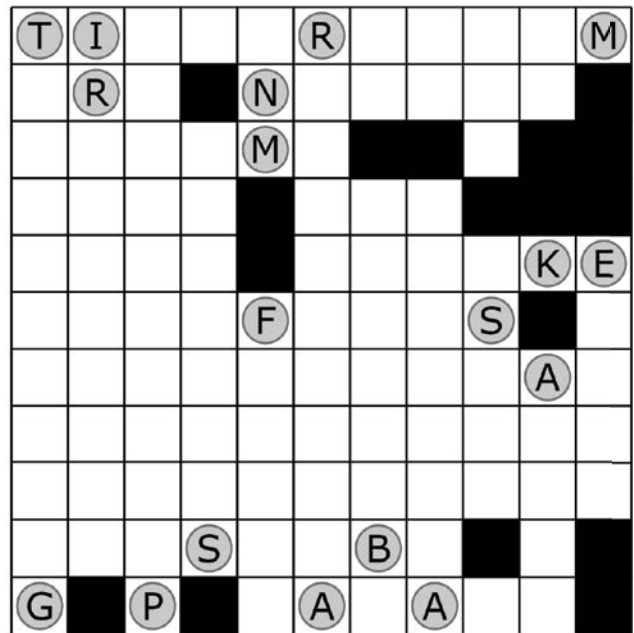

The 3 Witnesses

Help the three witnesses. Martin Harris, Oliver Cowdery, and David Whitmer through the maze to Angel Moroni and the golden plates.

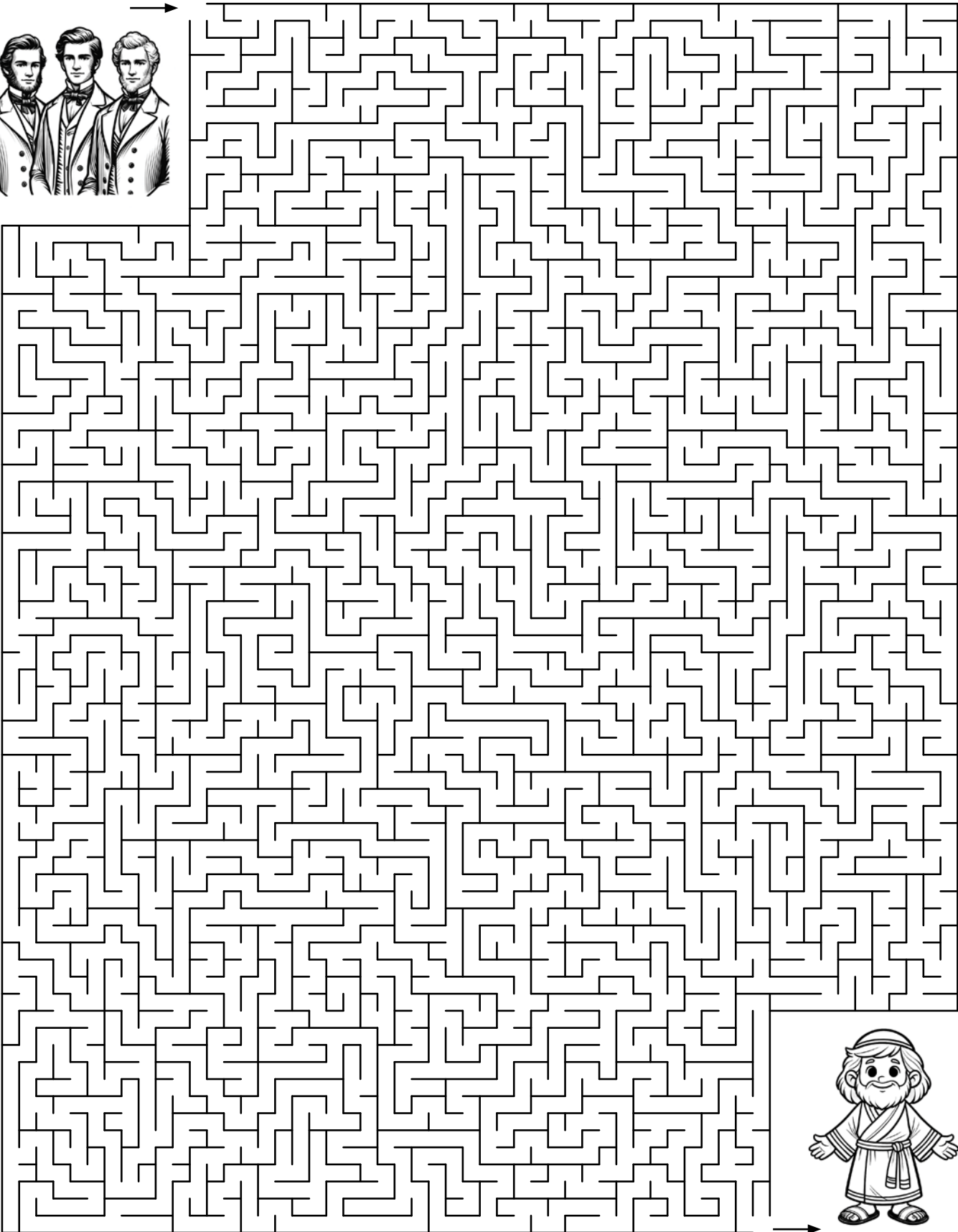

Moroni

February 17–23

Doctrine and Covenants 12–17; Joseph Smith—History 1:66–75

“Upon You My Fellow Servants”

Instructions: Using the Across and Down clues, write the correct words in the numbered grid below. Hint: all of the words in the crossword come from the scripture below.

Joseph Smith—History 1:66–72

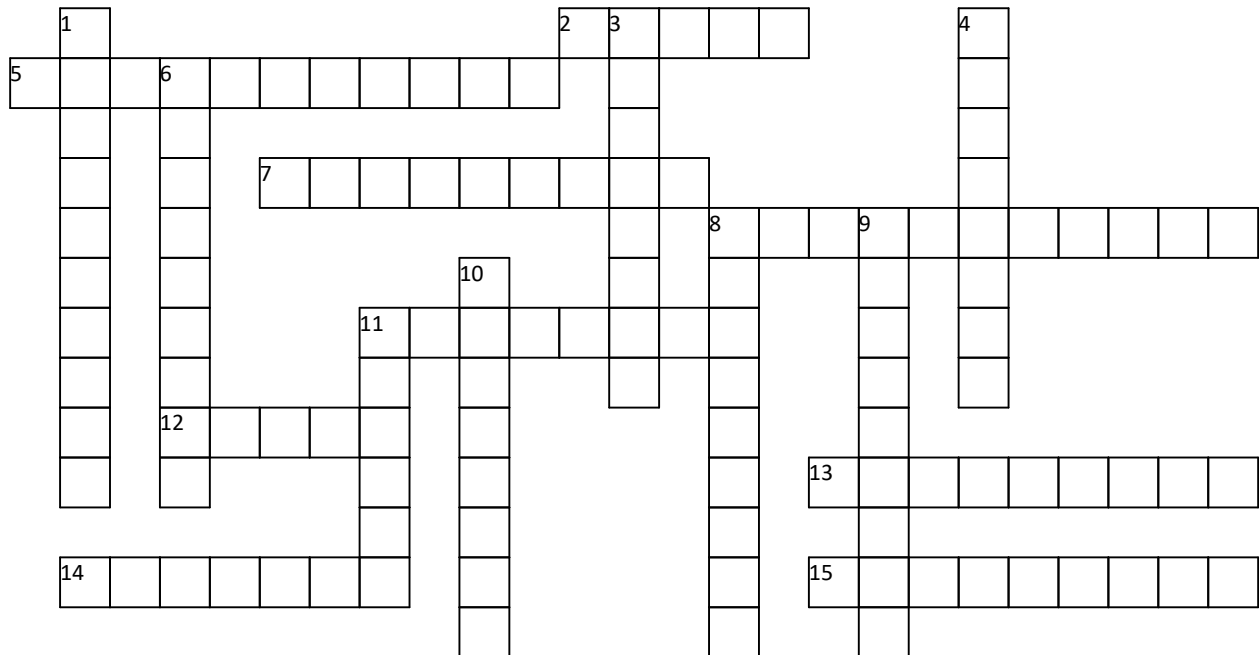

ACROSS

2. one of the twelve divisions of the calendar year
5. doing the work of the Lord on the earth
7. came down
8. a great Old Testament high priest, prophet, and leader who lived after the Flood and during the time of Abraham. He was called the king of Salem
11. a person working in the service of another
12. the third planet from the sun
13. restate from one language into another language
14. the act of coming to a certain place
15. the act of releasing from the guilt or penalty of

DOWN

1. a set of clear instructions
3. a gift to the Lord.
4. immersion in water by one having authority is the introductory ordinance of the gospel
6. a request for information (plural)
8. one who bears a message or does an errand
9. bestowed from a position of superiority
10. to appoint or confer authority or office.
11. a place of learning

February 24–March 2

Doctrine and Covenants 18

“The Worth of Souls Is Great”

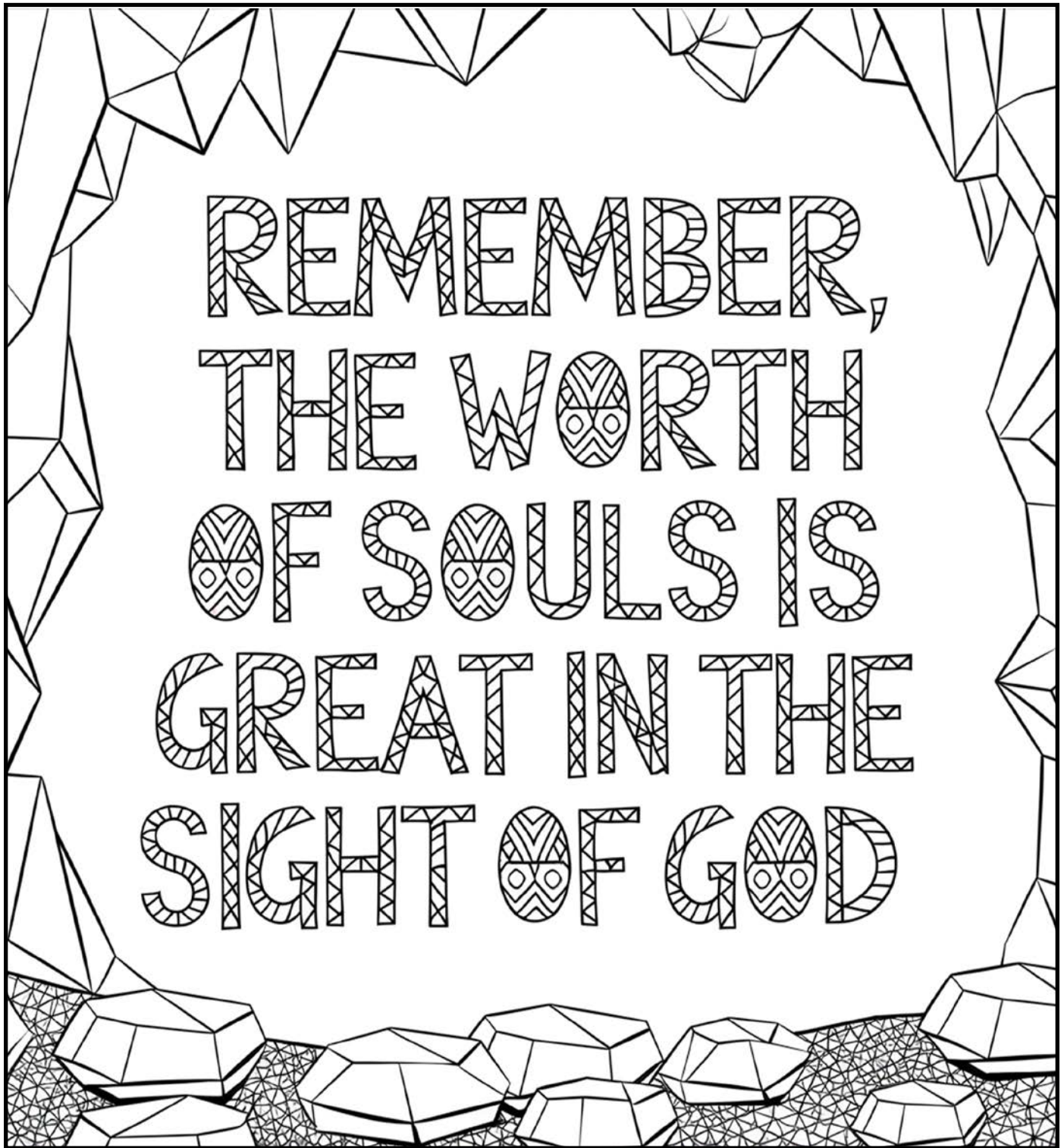

REMEMBER,
THE WORTH
OF SOULS IS
GREAT IN THE
SIGHT OF GOD

Doctrine and Covenants 18:10

February 24–March 2

Doctrine and Covenants 18

“The Worth of Souls Is Great”

Knight Moves - Find a Word

Instructions: Start with any letter in the puzzle to see if it's the beginning of a word. To get to the second letter, jump two squares in any direction except diagonally, and then one square in a different direction. Your path will look like a capital L. Only one route through the puzzle will make a word. Write the letters of the word you discover in the blanks below as you jump through the squares:

1 2 3 4 5 6 7 8

Now can you find this word in the following scripture?

Doctrine and Covenants 18:11

r	e	e
m		e
d	r	e

Translation Station

Instructions: Translate the sign language letters below into English to discover the hidden message. Write the alphabet letter beneath each hand sign. Use the key at the back of the book to help you.



February 24–March 2

Doctrine and Covenants 18

“The Worth of Souls Is Great”

Instructions: Connect all of the letters in the maze and then write the phrase in the blanks below. Don't be tricked by letters that take you into a dead end! There is only one path through the maze.

-----, -----

-----, -----
-----!

Doctrine and Covenants 18:16

U	L	T	L	U	L	U	O	S	O	U	O	U	L	T	H	A	T	U	O	U	H	A	V	
O	U	O	S	O	U	O	S	E	S	O	S	O	U	L	Y	T	Y	O	Y	O	U	H	A	
S	O	N	E	U	O	S	E	N	E	S	E	S	O	U	L	A	H	A	T	Y	O	U	H	
E	S	O	H	O	S	E	N	O	N	E	N	E	S	O	U	H	T	H	A	T	Y	O	U	
N	E	S	T	I	W	N	O	H	T	S	O	N	E	S	O	U	L	T	H	A	T	Y	O	
O	H	T	I	W	T	W	I	W	I	T	H	O	N	E	S	O	U	L	A	O	Y	O	U	
H	T	I	W	T	A	T	A	T	W	I	T	H	O	S	O	A	T	T	H	A	T	U	V	
T	I	W	T	A	E	R	E	A	T	W	I	T	N	L	T	H	A	T	Y	O	U	H	A	
I	W	T	A	E	R	G	R	E	A	T	W	I	T	U	L	T	T	Y	T	Y	O	U	H	
T	T	A	E	R	G	E	G	A	T	W	S	E	S	O	U	L	T	H	A	T	Y	O	A	
I	W	T	L	B	L	B	R	E	A	N	E	N	E	S	O	U	L	T	H	A	T	Y	O	
E	B	L	L	L	L	L	B	R	T	O	H	O	N	E	S	O	A	R	J	O	J	R	J	
B	L	L	I	W	I	L	L	G	R	I	T	H	O	N	O	T	H	U	R	J	R	U	O	
E	L	I	W	Y	W	L	B	E	T	W	I	T	H	O	U	L	O	O	U	O	U	R	Y	
B	L	L	Y	O	A	E	E	E	A	T	W	I	T	N	E	S	N	Y	F	Y	W	Y	F	
I	B	Y	O	J	T	R	G	R	E	T	I	T	H	O	N	E	D	F	I	W	O	F	I	
W	Y	O	J	R	W	T	R	E	W	H	T	H	O	T	E	M	N	I	W	O	N	I	W	
Y	O	J	R	U	T	A	E	A	T	S	U	S	T	N	M	O	A	W	O	N	D	W	O	
O	J	R	U	O	W	T	T	H	S	L	U	L	N	U	N	T	E	M	N	D	N	O	N	
J	R	U	O	Y	I	W	I	T	Y	U	O	U	U	S	U	N	M	O	M	E	A	N	D	
N	J	R	U	F	T	H	N	A	N	O	S	O	U	L	S	U	O	T	O	M	E	A	N	
D	O	O	F	I	H	E	G	M	A	S	Y	S	O	U	L	S	U	N	T	O	M	E	A	
N	O	N	I	W	O	N	G	M	A	N	Y	S	O	U	L	S	U	N	T	O	M	E	A	
Start	A	N	D	N	O	N	E	I	R	B	D	L	U	O	U	L	H	U	N	T	O	J	N	A
N	D	N	O	S	E	S	N	I	R	B	D	B	H	O	U	S	H	T	O	J	R	D	N	
D	N	L	U	O	S	O	G	N	I	U	O	H	S	U	O	U	F	I	Y	R	U	O	Y	
Y	T	A	T	U	O	U	H	A	N	L	U	L	U	O	Y	F	I	Y	O	J	R	U	E	
O	A	H	T	L	U	L	T	A	T	O	W	D	A	E	R	E	A	T	W	I	L	L	B	
E	T	A	H	T	L	M	Y	F	A	H	R	H	O	A	G	A	T	L	I	L	L	Y	E	
V	Y	T	A	T	T	F	M	M	T	H	E	R	H	O	W	H	T	H	I	E	M	O	M	
A	H	U	O	A	H	O	M	O	D	G	N	I	K	E	H	T	O	T	N	U	N	T	O	
H	U	O	Y	T	A	T	Y	O	U	H	A	V	E	B	R	O	U	G	H	T	U	N	T	

Finish

February 24–March 2

Doctrine and Covenants 18

“The Worth of Souls Is Great”

Handwriting Practice

Practice your handwriting by tracing the sentence below. Then use the blank lines to write the sentence on your own.

I am of great worth to God.
I am of great worth to God.

Fallen Phrase

Instructions: The letters in each column have fallen from the grid. Put them back correctly to rebuild the phrase. Cross out each letter in the jumble below once you place it in the grid. Pay attention because the letters in each column are scrambled. Start with simple 1 or 2 letter words and use the process of elimination. To check your answer, read:

Doctrine and Covenants 18:12–13

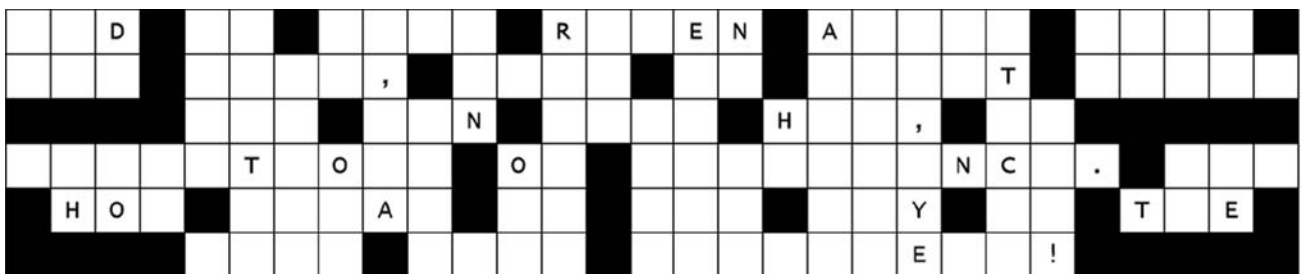

G
S O L T S S I J T
D G R L T A H H S N O I O
A N I E U H A T H H U T R E P I I G H H N I N
C O N D A L I E N S T I F N T E P E N M A T N N B R A M G
T H E W H E A D M E H A T I R O E E M T A I O E F R H N D

February 24–March 2

Doctrine and Covenants 18

“The Worth of Souls Is Great”

Word Sudoku

Instructions: Solve this word sudoku puzzle the same way that you’d solve a numeric sudoku. Each of the bold words in the scripture below is found once in every row, column and 3×3 box.

I Want to Be a Missionary Now, Children’s Songbook

I want to be a **missionary now**. I don’t want to wait until I’m grown. I want to **share** the **gospel** while I’m **young**, For I have a **testimony** of my **own**. I want to tell my **friends** about our church And the **happiness** it brings to me. I’ll tell them how the gospel was restored, Tell them how the Book of Mormon came to be.

happiness					share			friends
missionary		young	now					own
	friends	now				testimony		
testimony			missionary		happiness	own		
		friends	testimony				missionary	
	happiness			now		friends	testimony	
now			friends					young
friends	share				missionary			testimony
young	testimony		share					gospel

February 24–March 2

Doctrine and Covenants 18

“The Worth of Souls Is Great”

Word Search

Instructions: Find the bold words from the scripture in the word search puzzle. Each word could be hidden forwards, backwards, up, down, or diagonally.

Doctrine and Covenants 18:34–36

These **words** are not of men nor of man, but of me; wherefore, you shall **testify** they are of me and not of man; For it is my voice which **speake**th them unto you; for they are **given** by my **Spirit** unto you, and by my **power** you can **read them one** to **another**; and **save** it were by my power you could not **have** them; Wherefore, you can testify that you have **heard** my **voice**, and **know** my words.

H	C	I	B	O	M	O	H	O	F	M	X	K	Q	J
A	D	M	N	Q	C	T	M	G	F	X	C	D	Y	X
Z	V	E	B	Q	E	E	U	K	P	U	R	E	A	D
H	A	V	E	K	H	R	P	Y	H	N	A	Y	Q	E
R	Q	T	A	T	O	X	O	S	B	Q	E	Q	I	Y
K	E	E	I	N	E	Z	K	D	N	S	M	V	H	O
R	P	W	M	U	W	T	I	R	I	P	S	E	I	R
S	L	F	O	F	P	D	P	A	H	I	A	P	B	G
J	A	H	U	P	K	A	L	M	F	R	L	E	L	Z
W	X	V	L	Y	S	B	C	B	D	C	V	S	A	Q
L	K	T	E	U	V	K	I	F	V	O	J	J	U	F
Y	C	O	F	A	P	N	Y	F	I	T	S	E	T	L
M	S	D	R	O	W	O	Z	C	F	I	S	S	Q	I
F	G	N	Y	R	G	W	E	A	N	O	T	H	E	R
E	Y	P	S	S	K	D	Z	P	P	N	C	F	A	P

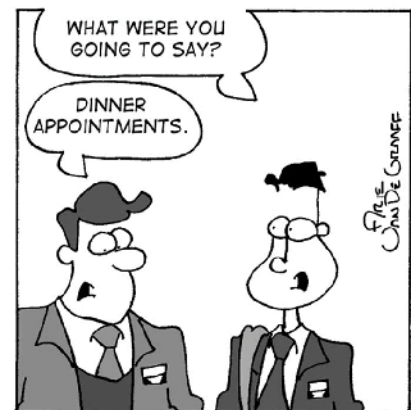
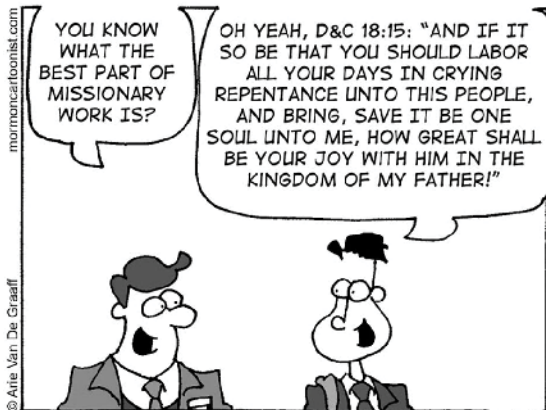

March 3–9

Doctrine and Covenants 19

“Learn of Me”

Word Spiral

Instructions: Fill in the blank puzzle grid using the bold words from the scripture or phrase below. *The bold words may not all be used!* Use the letter hint below and count the letters of the bold words to figure out where each word goes. Then transfer the letters that have little numbers in their box to the hidden word at the bottom of the puzzle. Check the answer on ColorMeChristian.org.

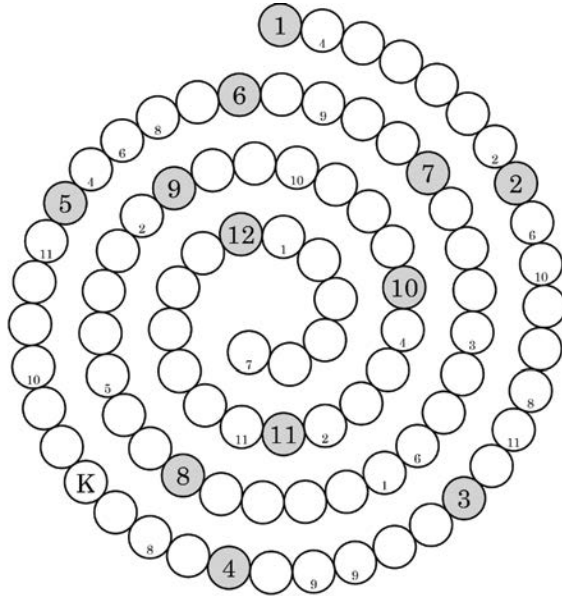

Mosiah 3:7

And lo, he shall **suffer temptations**, and **pain of body, hunger, thirst**, and **fatigue**, even more than man can suffer, except it be unto death; for behold, **blood** cometh from every **pore**, so great shall be his **anguish** for the **wickedness** and the **abominations** of his **people**.

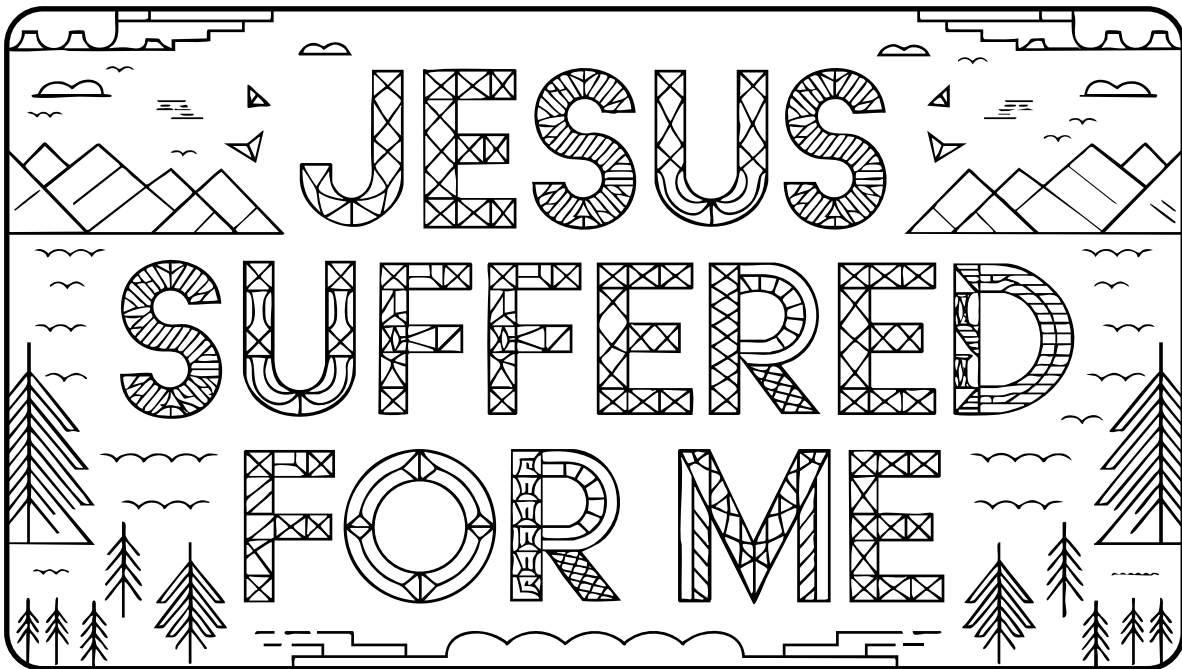

March 3–9

Doctrine and Covenants 19

“Learn of Me”

Missing Vowels Word Search

Instructions: Find the hidden words. The words have been placed horizontally, vertically, diagonally, forwards, or backwards, and the vowels have been removed. When you locate a word, draw an ellipse around it and fill the vowels in.

Doctrine and Covenants 19:18–19, 24

Which suffering caused **myself**, even God, the greatest of all, to **tremble** because of **pain**, and to **bleed** at **every pore**, and to **suffer** both **body** and **spirit**—and would that I might not **drink** the **bitter cup**, and shrink—Nevertheless, **glory** be to the **Father**, and I **partook** and **finished** my **preparations** unto the **children** of men. I am **Jesus** Christ; I came by the **will** of the Father, and I do his will.



Word Guess

Instructions: Write your word guesses in the puzzle below. For extra hints, look at the words/phrases in the scripture below. Check the answer on ColorMeChristian.org

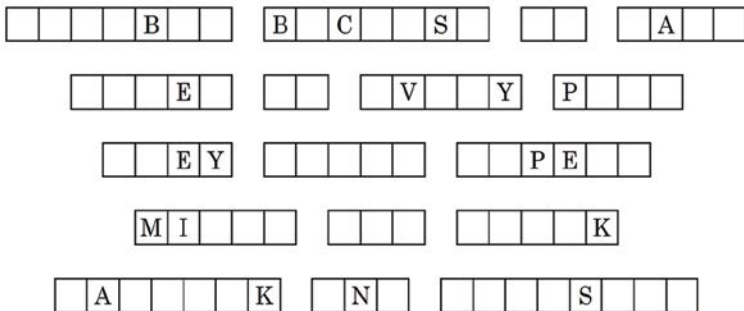

Doctrine and Covenants 19:16–19

For behold, I, God, have suffered these things for all, that they might not suffer if they would repent; But if they would not repent they must suffer even as I; Which suffering caused myself, even God, the greatest of all, to tremble because of pain, and to bleed at every pore, and to suffer both body and spirit—and would that I might not drink the bitter cup, and shrink— Nevertheless, glory be to the Father, and I partook and finished my preparations unto the children of men.

Hidden Picture: These children want to repent and return to Christ, but first they need to find him. Can you find 2 pictures each of Christ and the children in the hidden picture below? It will be tricky; the pictures may be smaller, on their side, or even upside down! Then, see if you can find one copy of the animals as well.

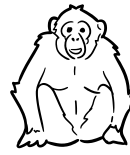
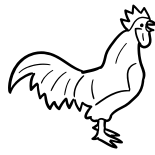

March 3–9

Doctrine and Covenants 19

“Learn of Me”

Pray always, and I will **pour** out my Spirit upon you, and great shall be your blessing—yea, even more than if you should obtain treasures of earth and corruptibleness to the extent thereof.

Doctrine and Covenants 19:38

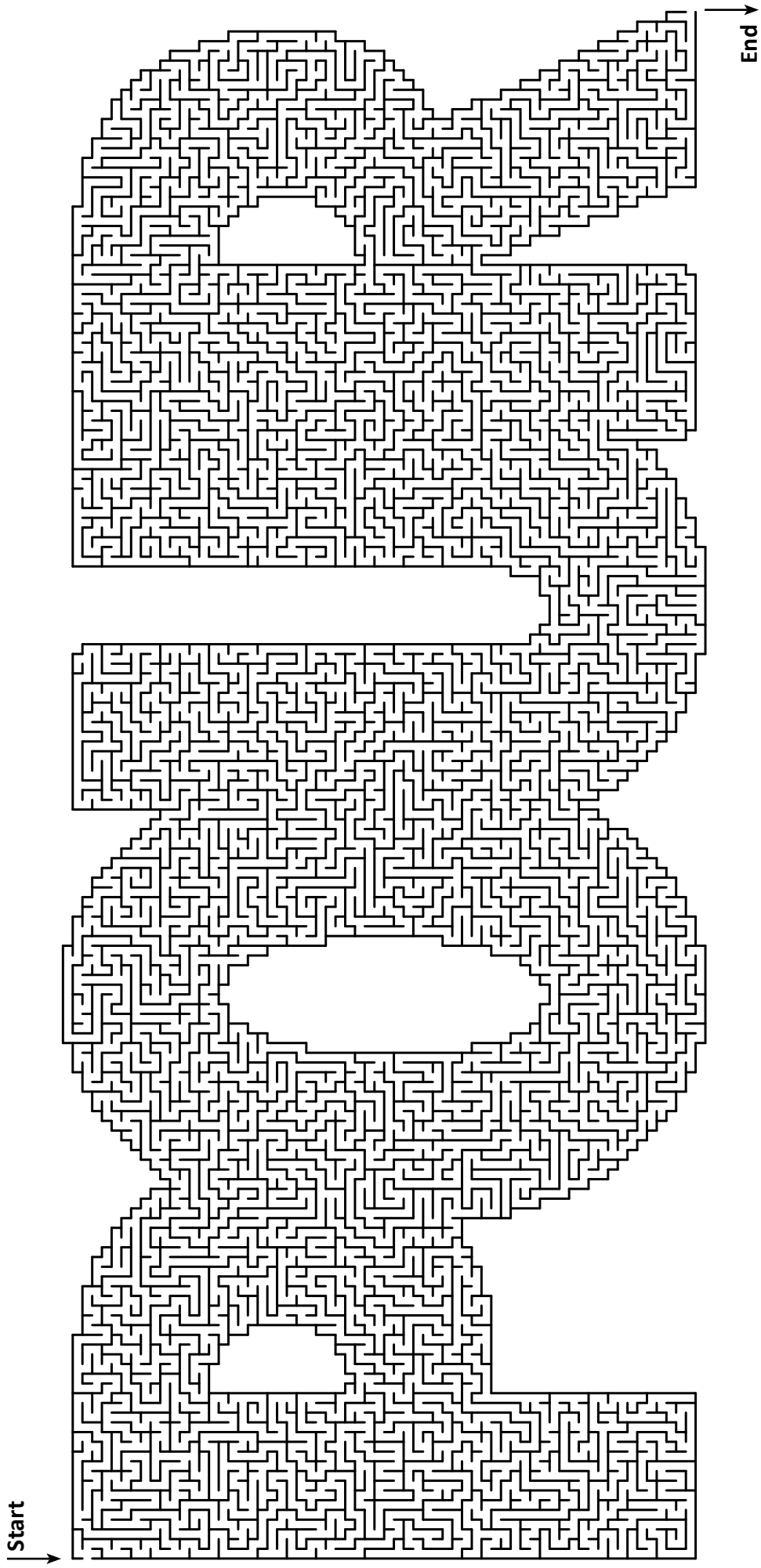

March 3-9

Doctrine and Covenants 19

"Learn of Me"

Handwriting Practice

Practice your handwriting by tracing the sentence below. Then use the blank lines to write the sentence on your own.

*Jesus obeyed Heavenly Father,
even when it was hard.*

mormoncartoonist.com

© Arie Van De Graaff

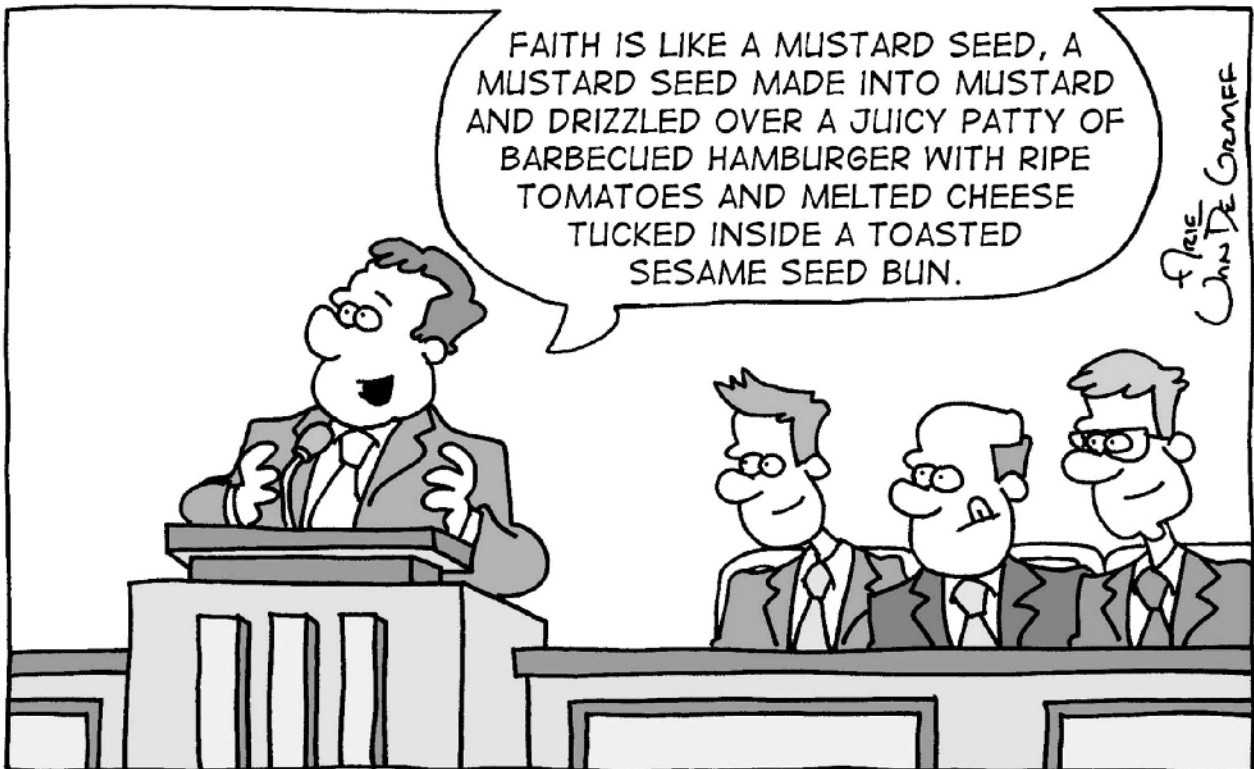

March 10–16

Doctrine and Covenants 20–22

“The Rise of the Church of Christ”

Wacky Word Trails

Instructions: Start with the circled letter, use the clues to find and mark the trail of letters of all the connected bolded words from the scripture through the maze to the last letter. The path can wander up, down, left, and right at any point, even in the middle of the word.

Doctrine and Covenants 20:77

O God, the Eternal Father, we ask thee in the name of thy Son, Jesus Christ, to **ble**ss and **sanctify** this **br**ead to the **so**uls of all those who **partake** of it, that they may **eat** in **remembrance** of the **bo**dy of thy **Son**, and **wit**ness unto thee, O God, the **Eternal Father**, that they are **willing to take upon** them the **name** of thy Son, and **always remember** him and **keep** his **commandments** which he has given them; that they may always have his **Spirit** to be **with** them. Amen.

F	A	T	H	E	R	W	C	G	T	A	N	C	T	I
N	A	W	L	E	M	I	L	B	B	S	E	B	O	F
O	Y	S	A	S	A	Z	L	G	I	T	K	A	D	Y
S	S	L	U	O	N	S	I	N	N	O	T	T	Y	P
X	T	A	B	S	S	K	O	R	S	L	H	R	R	A
A	L	Y	L	E	P	J	Q	C	F	V	O	C	T	D
V	R	X	B	T	I	F	K	P	H	R	X	W	A	K
R	T	S	P	I	R	G	D	G	E	F	M	E	M	E
N	A	E	S	I	C	M	O	C	R	E	B	R	E	R
V	O	S	S	P	D	M	J	N	T	E	M	E	M	B
Y	C	P	E	H	S	A	N	E	S	R	E	N	A	R
V	I	T	N	P	E	K	D	M	N	J	G	C	D	D
Q	W	N	O	P	U	D	U	R	E	K	L	E	M	D
L	X	A	D	U	R	N	L	K	E	N	A	E	I	G
Z	H	E	R	B	H	T	I	W	P	R	E	T	C	B

Fill in the Blank

Doctrine and Covenants 20:37

And again, by way of commandment to the church concerning the _____ of baptism-All those who _____ themselves before God, and _____ to be _____, and come forth with _____ hearts and _____ spirits, and _____ before the _____ that they have truly _____ of all their sins, and are willing to _____ upon them the _____ of Jesus Christ, having a determination to _____ him to the end, and truly manifest by their _____ that they have _____ of the Spirit of Christ unto the _____ of their _____, shall be received by baptism into his church.

broken	works	repented	serve	desire	remission
baptized	received	contrite	name	manner	church
take	humble	witness	sins		

The Church Is Organized in Fayette

By Arie Van De Graaff

The Church of Jesus Christ of Latter-day Saints was organized on April 6, 1830, inside the Peter Whitmer home in Fayette, New York. Find the hidden objects in this scene of the Whitmer home.

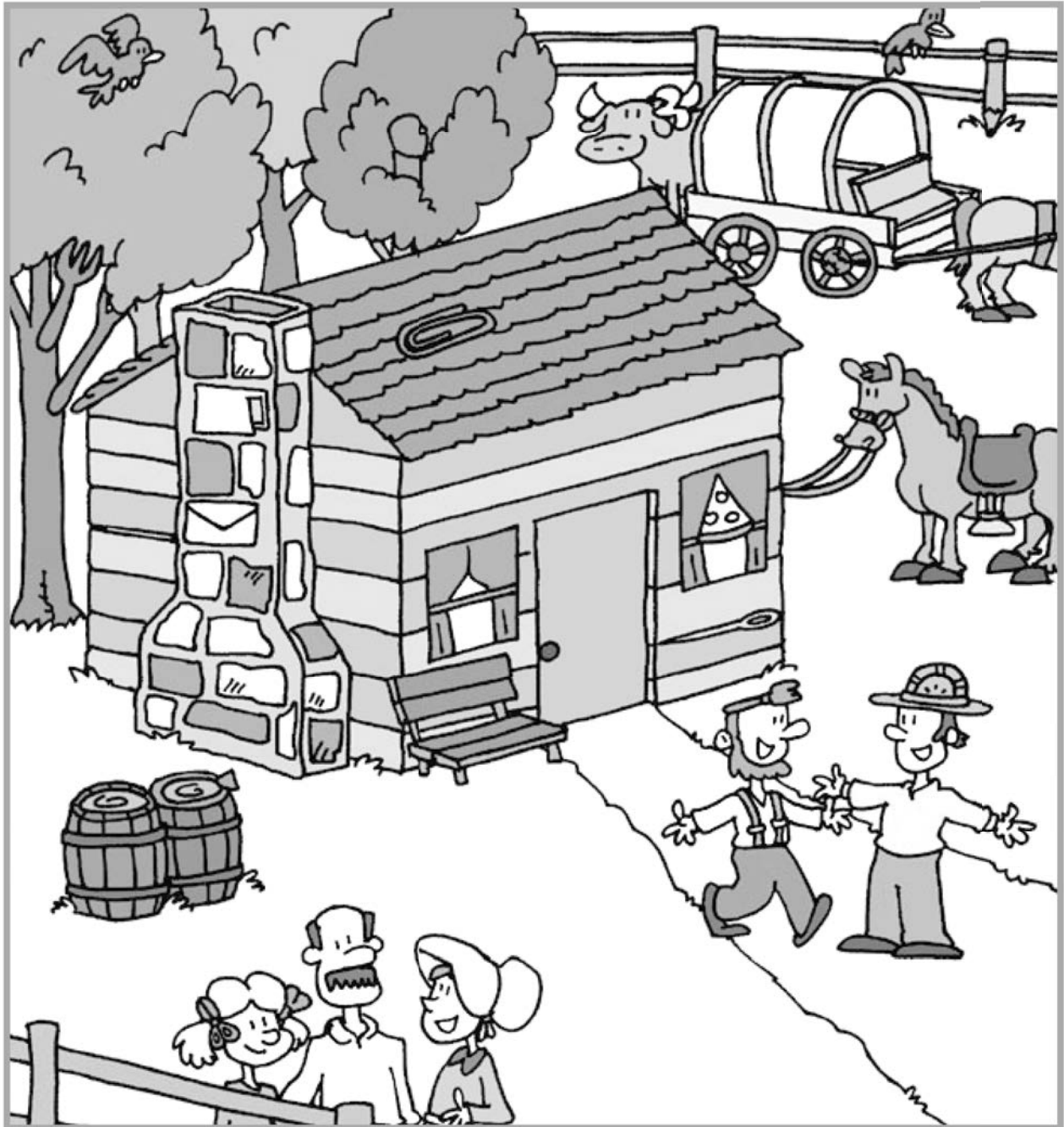

March 10–16

Doctrine and Covenants 20–22

“The Rise of the Church of Christ”

Instructions: Fit the bold words from the scripture below into the encircled squares. Words will read forward, backward, up, down, and diagonally and will normally cross other words. Start with the hints provided.

Doctrine and Covenants 20:21–23

Wherefore, the **Almighty** God **gave** his **Only Begotten Son**, as it is **written** in those **scriptures** which have been given of him. He **suffered temptations** but gave **no heed** unto them. He was **crucified, died**, and **rose again** the **third day**;

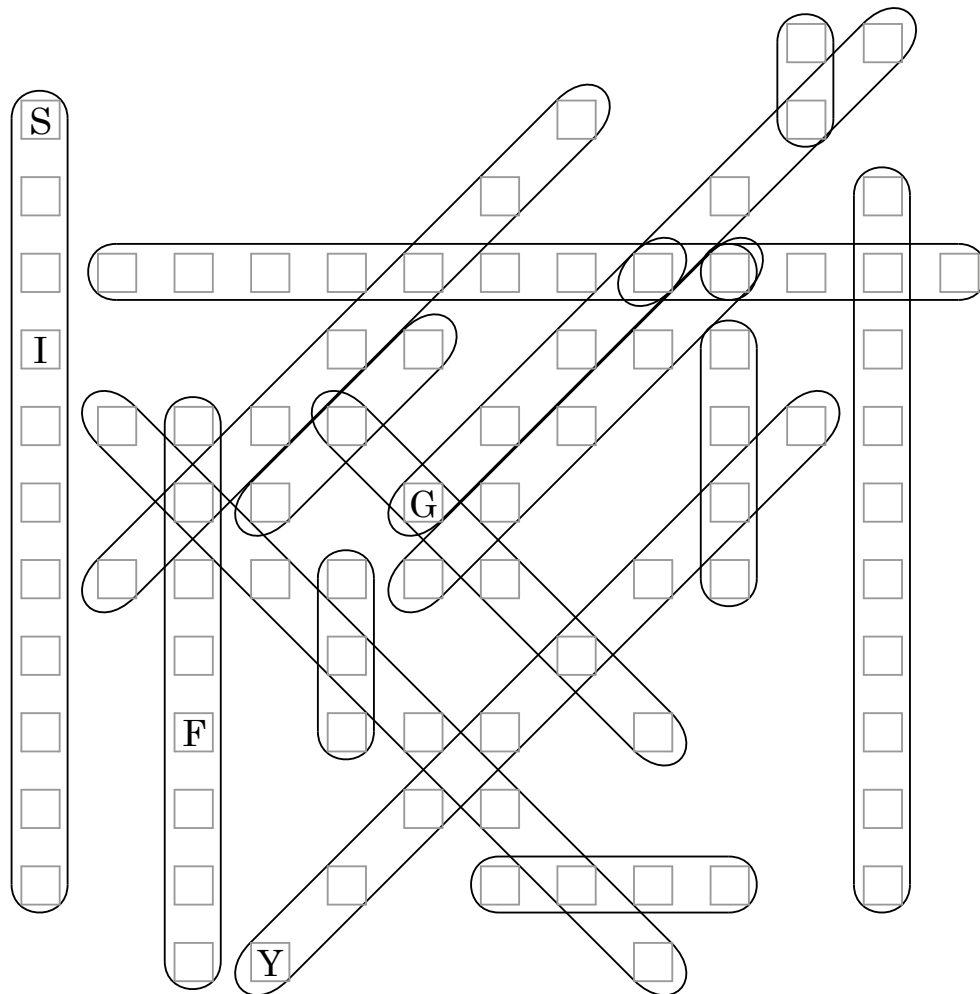

Almighty
written
heed
third

gave
scriptures
crucified
day

Only
suffered
died

Begotten
temptations
rose

Son
no
again

March 10–16

Doctrine and Covenants 20–22

“The Rise of the Church of Christ”

Handwriting Practice

Practice your handwriting by tracing the sentence below. Then use the blank lines to write the sentence on your own.

*Jesus blesses me as I follow
His prophet.*

Word Square

Instructions: Word squares are a liike Sudoku puzzles, but each letter can occur only once in each row and in each column. Check your puzzle against the answer key on ColorMeChristian.org. Every row and column must contain every letter in the word **CONFIRM**. This word can be written in the gray row.

Doctrine and Covenants 20:41

And to **confirm** those who are baptized into the church, by the laying on of hands for the baptism of fire and the Holy Ghost, according to the scriptures;

		M			R	
		I		N	F	C
R		F		C	M	I
C		O	I	M	N	
		R	C			
		C	M	O		
I						O

Following Jesus

When we are baptized and confirmed, we promise to follow Jesus Christ. Help these children who have just been baptized and confirmed follow Jesus through the maze.

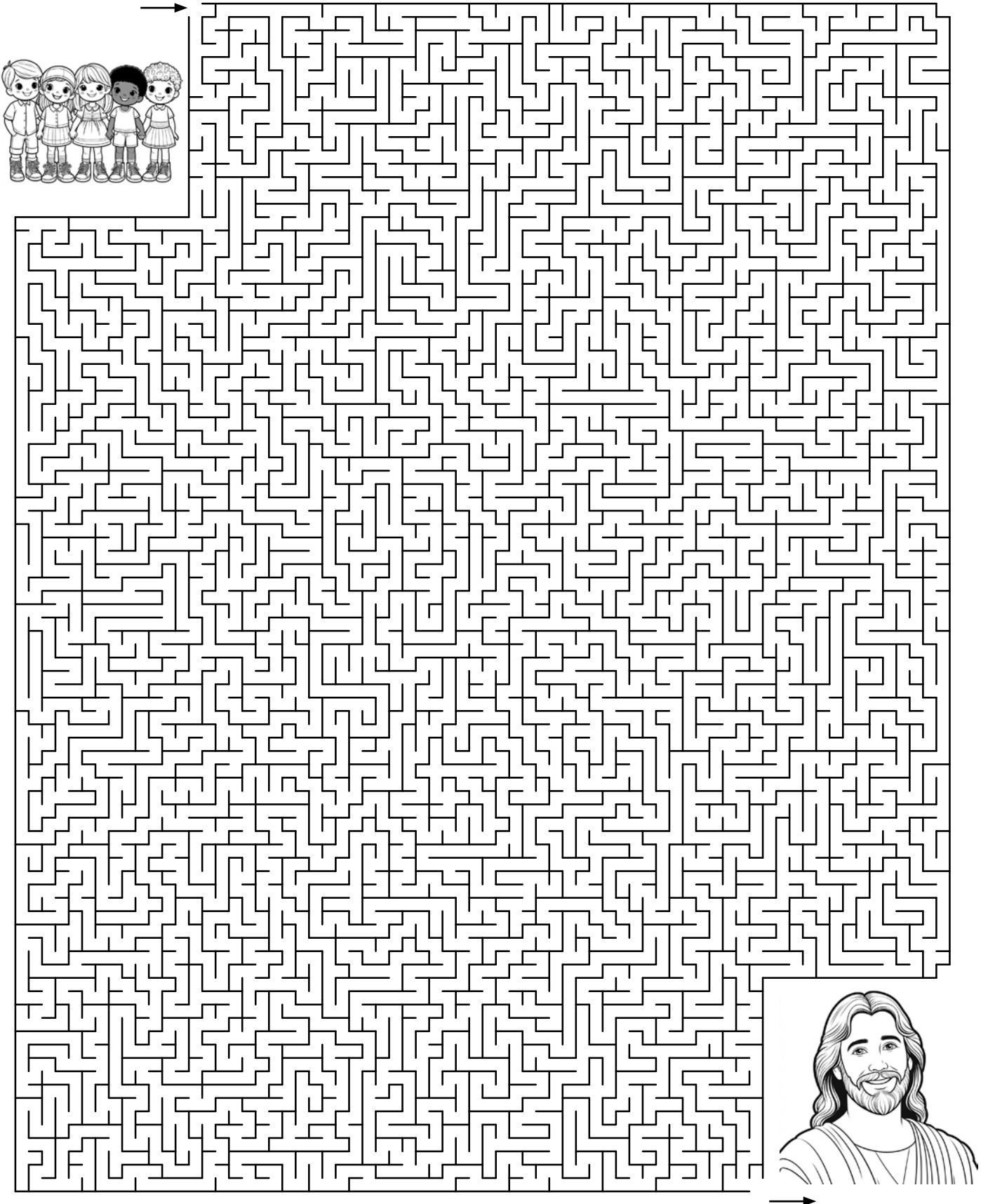

March 17–23

Doctrine and Covenants 23–26

“Seek for the Things of a Better World”

Word Angles

Instructions: Find the bold words from the scripture. Each word path may run north, east, south, or west, may make one right-angled turn, and may cross another word path. A few words may make no right angle turn at all.

Mosiah 18:10

Now I say unto you, if this be the **desire** of your **hearts**, what have you against being **baptized** in the **name** of the **Lord**, as a **witness** before him that ye have **entered** into a **covenant with** him, that ye will **serve** him and **keep** his **commandments**, that he may **pour** out his **Spirit more abundantly** upon you?

Q	U	F	H	T	I	W	L	K	P	R	P	A	V	E	K
S	L	O	R	D	O	B	M	E	E	P	S	B	J	V	S
X	X	I	L	L	G	Q	F	M	E	G	B	U	W	S	S
O	I	U	B	S	P	Y	L	T	N	A	D	N	M	W	E
R	E	S	L	P	Y	N	L	V	O	A	J	W	I	T	N
V	S	V	L	I	R	I	T	R	D	D	N	M	U	K	E
E	O	P	G	D	N	J	T	H	E	S	M	O	R	E	D
D	T	N	A	N	G	H	K	C	Z	W	Y	L	Z	U	E
A	Q	R	S	E	P	W	T	I	I	T	P	A	B	U	S
J	T	F	T	V	B	O	K	W	B	X	Q	I	E	R	I
H	E	A	R	O	K	S	E	R	N	W	W	C	L	K	I
V	E	B	N	C	Z	T	J	O	P	W	Z	J	J	F	O
J	O	M	C	S	W	N	O	B	O	D	E	R	E	T	Z
I	D	E	O	Q	I	E	C	R	U	U	T	T	I	N	X
L	O	M	A	N	O	M	D	N	O	A	I	E	Y	E	G
Y	F	P	I	Z	J	D	N	A	M	M	O	C	T	K	O

Word Star

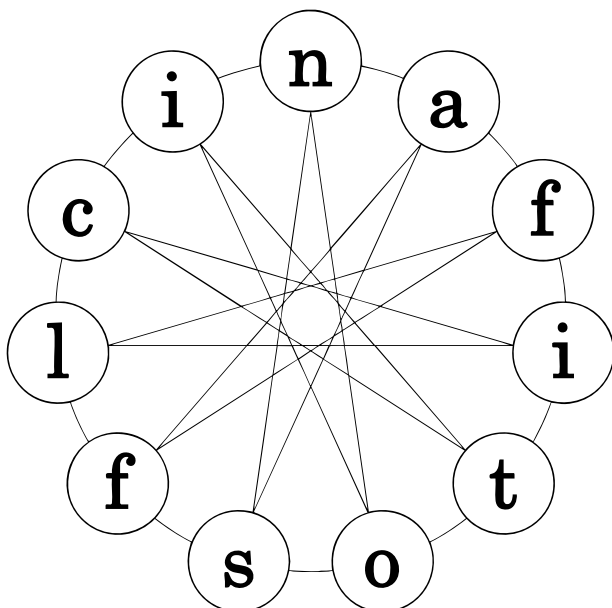

Instructions: Only one route through the word star will make a word. Try each letter and follow the pathway through the star to see if it makes a word.. IF you need a hint, look at the words in the scripture below. Write the letters of the word you discover in the blanks below as you travel through the star:

Now can you find this word in the following scripture?

Doctrine and Covenants 24:1

Mystery Picture Graph

Instructions: Find the mystery picture below by plotting and connecting the points of each line on the coordinate graph. Connect all the points in Line 1, stop, pick up your pencil, and then connect all the points in Line 2, and so on for the rest of the lines. The dot for the first (X,Y) coordinate pair on Line 1 has been placed for you.

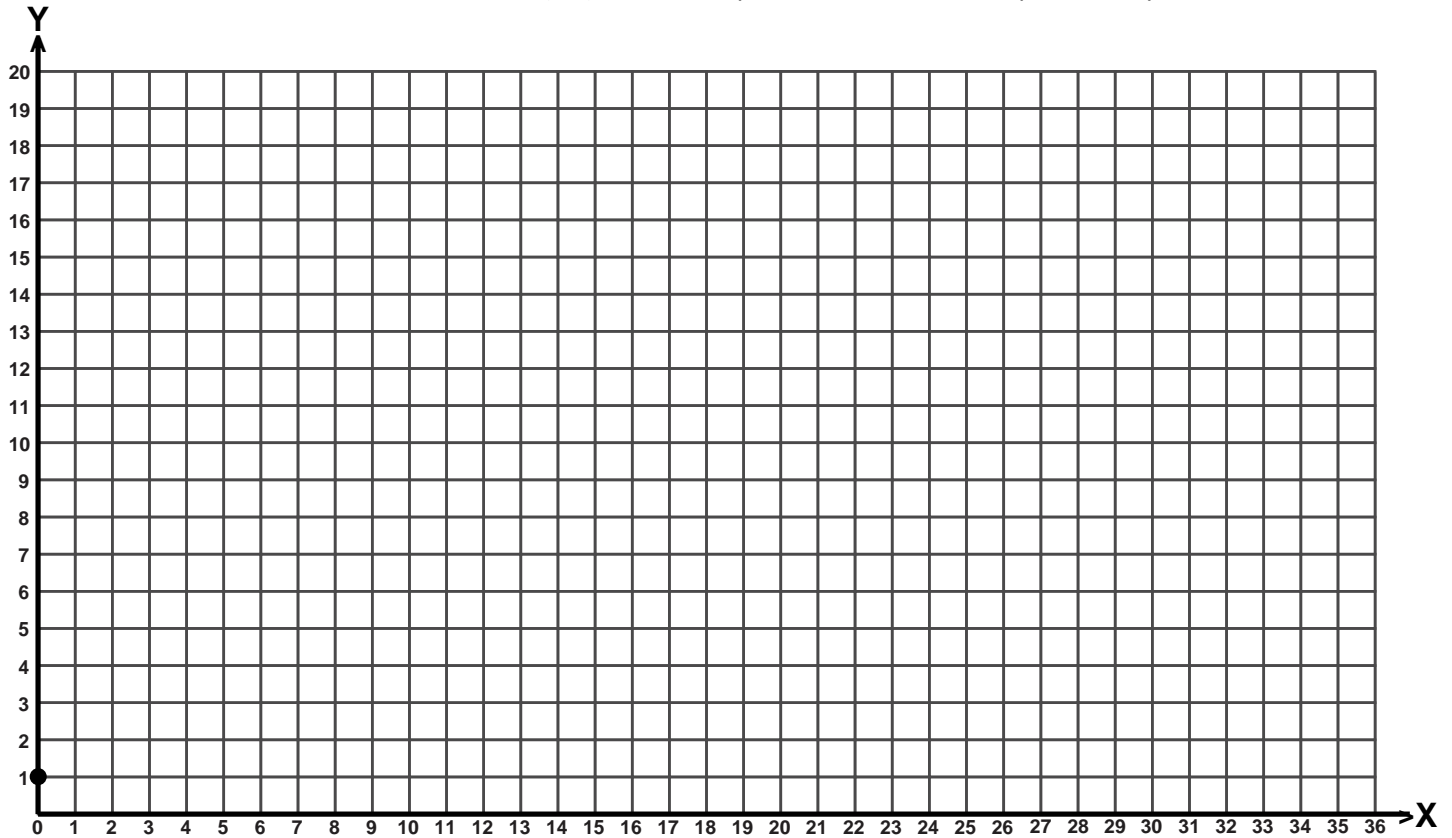

Line 1	(0, 1)	(1, 0)	(7, 3)	(6, 4)	(0, 1)	Line 2	(0, 14)	(2, 9)	(3, 10)	(5, 7)	(6, 4)	(8, 3)
(9, 3)	(10, 4)	(12, 4)	(12, 6)	(10, 8)	(12, 7)	(13, 8)	(10, 9)	(7, 13)	(8, 14)	(6, 17)	Line 3	(12, 6)
(33, 17)	(32, 18)	(11, 7)	Line 4	(6, 6)	(9, 3)	Line 5	(7, 7)	(10, 4)	Line 6	(8, 8)	(11, 4)	Line 7
(10, 8)	(12, 5)											



March 17–23

Doctrine and Covenants 23–26

“Seek for the Things of a Better World”

Translation Station

Instructions: Translate the Morse code below into English to discover the hidden message. Write the alphabet letter beneath each Morse Code letter. Each letter, number, and punctuation is separated by a slash: /. Use the key at the back of the book to help you.

· - - / · · · · / · / · - · / · / · · - · / - - - / · - · / · / - - · - - - / · - · · / · / · · - · / - /
· · - / · - - · / - / · · · · / - - - · / · · · · / · / · - / · - · / - /
· - / - · / - · · / · - · / · / · - - - · / - - - · / · / - · - · / · / - - - - - /
· - / - · / - · · / - · - · / · · · · / · / · - / · · - · / · / · - · / - · / - - - · /
- / · · · · / · / - · - · / - - - · / · · - · / · / - · / · - / - · / - / · · · · /
· - - / · · · · / · / - · - · / · · · · / - / · · · · / - - - / · · - / · · · · / - /
- - / · - / - · · / · / · - · - - · / - · · / - - - · / - · - · / · / - · / · /
· - / - · / - · · / - · - · / - - - · / · · - · / · / - · / · - / - · / - / · · · · /
· · - - / · · · · / - - - · · / · - - - · / · · - - /

Letterbox Puzzle

Instructions: Find the hidden word in the puzzle below by crossing out all letters that occur twice or more. Capitalized and lowercase letters count as unique letters for this puzzle. The letters left over will form a word. Write down the left over letters like you would read a book, from left to right and top to bottom. Then find the hidden word in the scripture or phrase below and circle it.

Doctrine and Covenants 24:8

Be patient in afflictions, for thou shalt have many; but endure them, for, lo, I am with thee, even unto the end of thy days.

Write the hidden word:

S	f	I	I	p	W
a	g	S	Q	d	T
o	i	o	q	f	s
q	Q	E	H	H	g
d	N	W	H	F	w
F	P	P	s	w	†

March 17–23

Doctrine and Covenants 23–26

“Seek for the Things of a Better World”

Unscrambler

Instructions: Unscramble the words below; look at the bold words in the scripture for a hint.

Doctrine and Covenants 20:37

And again, by way of commandment to the church concerning the manner of baptism—All those who humble themselves before God, and desire to be baptized, and come forth with **broken** hearts and **contrite** spirits, and **witness** before the church that they have truly **repented** of all their sins, and are **willing** to take upon them the **name** of **Jesus** Christ, having a **determination** to **serve** him to the end, and truly **manifest** by their **works** that they have received of the Spirit of Christ unto the remission of their sins, shall be **received** by baptism into his church.

sswitne _____

eserv _____

drepente _____

swork _____

ngwilli _____

ivedrece _____

ritecont _____

kenbro _____

estmanif _____

usjes _____

enam _____

tiondetermina _____

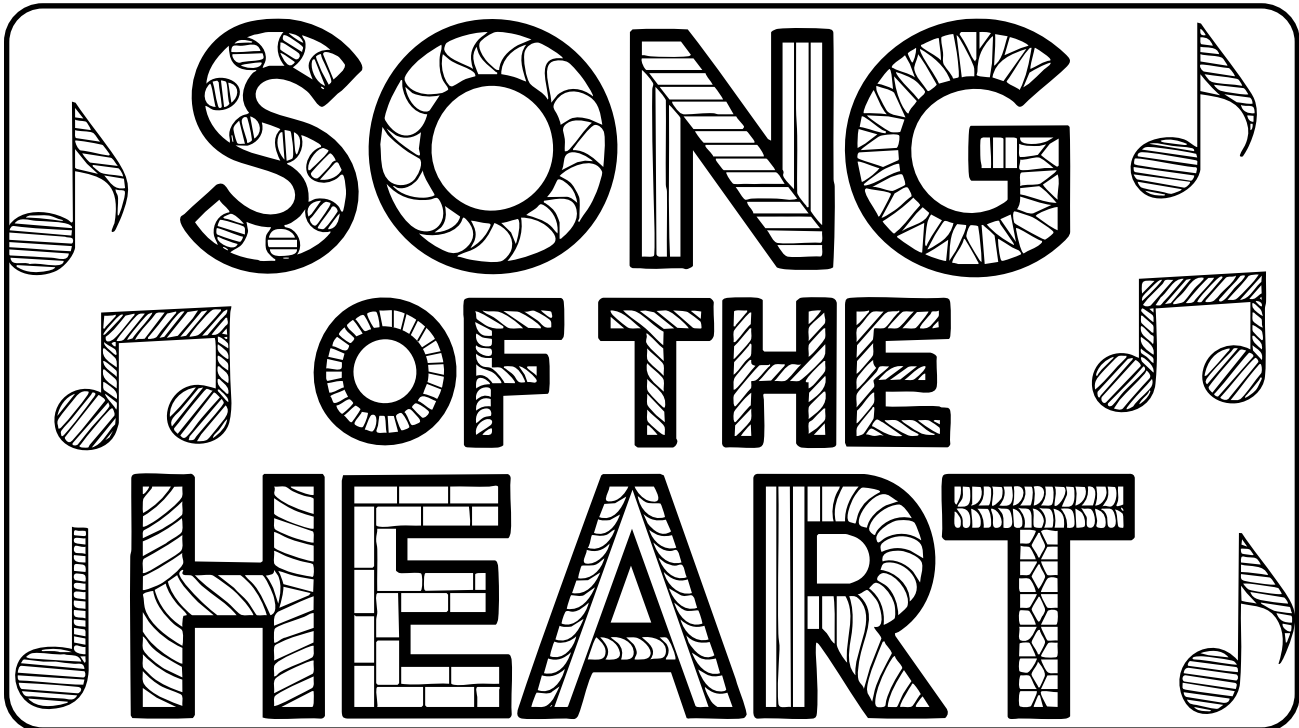

For my soul delighteth in the song of the heart; yea, the song of the righteous is a prayer unto me, and it shall be answered with a blessing upon their heads. (Doctrine and Covenants 25:12)

March 17–23

Doctrine and Covenants 23–26

“Seek for the Things of a Better World”

Instructions: Connect all of the letters in the maze and then write the phrase in the blanks below. Don't be tricked by letters that take you into a dead end! There is only one path through the maze.

-----; -----
-----,
-----.

Doctrine and Covenants 25:12

Start

U	I	L	E	L	I	G	I	G	H	S	U	O	E	T	H	G	I	G	H	T	E	O	U
O	S	E	D	E	L	I	L	I	G	I	S	U	O	E	T	H	R	E	T	E	O	I	S
M	Y	D	L	D	E	D	E	L	I	G	H	S	U	G	I	R	E	E	E	O	U	S	I
R	M	L	U	L	U	L	D	E	O	H	H	H	G	I	R	E	H	Y	A	R	P	A	S
O	R	U	O	S	O	U	L	D	S	O	T	F	I	R	E	H	T	E	E	A	N	S	W
F	O	R	M	Y	S	O	U	L	E	S	O	O	G	I	R	T	F	R	B	D	E	R	E
O	R	M	Y	U	O	U	L	T	H	E	S	G	N	H	T	F	O	U	L	W	H	A	B
R	S	Y	G	L	U	L	I	N	T	H	E	S	O	N	F	O	G	N	L	I	T	H	A
T	H	G	I	L	L	T	H	I	N	T	H	E	S	O	N	G	N	T	A	H	S	T	B
E	T	H	G	E	D	E	I	N	T	H	E	S	O	T	F	O	O	A	N	D	I	L	
T	H	G	I	L	E	T	E	T	H	O	S	O	E	H	T	F	S	M	E	A	N	D	E
E	T	E	T	I	L	H	T	E	I	N	O	N	H	E	H	T	E	H	T	A	E	Y	S
T	E	T	H	G	I	G	H	T	H	I	N	T	E	H	E	H	E	H	E	A	R	T	S
H	T	E	T	H	G	E	T	E	T	N	T	H	E	E	H	E	H	E	N	Y	T	N	I
I	H	T	E	T	E	T	H	T	H	I	N	T	S	T	E	H	T	N	O	P	U	G	N
N	I	H	T	E	T	N	I	H	T	N	T	H	S	R	A	E	H	T	N	O	P	U	G
T	N	I	H	T	H	T	N	I	N	T	H	S	Y	M	R	O	E	H	T	N	O	P	U
H	E	N	I	H	I	H	E	H	T	H	E	Y	M	R	O	F	S	F	S	T	N	O	P
E	S	T	N	I	N	E	S	E	S	E	S	S	Y	O	F	S	D	A	D	I	E	N	O
S	E	H	T	N	T	H	O	S	O	S	O	O	M	R	S	D	A	E	I	E	H	T	N
O	S	E	H	T	H	E	O	G	N	G	N	U	Y	M	F	S	D	H	R	I	E	H	T
N	O	N	E	H	H	T	F	O	G	L	U	O	S	Y	S	D	A	E	H	E	A	D	S
G	N	O	S	E	E	H	T	F	E	D	L	U	O	U	F	S	D	M	R	O	F	S	F
O	G	N	O	E	H	E	G	I	L	E	D	L	U	L	U	O	S	Y	M	R	O	F	O
F	A	G	N	A	E	H	H	G	I	G	E	D	L	D	L	U	O	U	Y	M	R	O	R
A	E	Y	T	R	A	E	T	E	T	H	L	E	D	E	D	L	U	O	S	Y	M	R	M
T	A	E	Y	T	R	A	H	T	E	T	I	L	E	L	E	D	L	U	O	S	Y	M	Y
H	O	S	E	H	T	N	I	H	T	H	T	I	G	H	G	I	D	L	U	O	S	Y	S
G	N	O	S	E	H	T	N	I	N	T	E	T	H	G	I	L	E	D	L	U	O	U	O

Finish

March 17–23

Doctrine and Covenants 23–26

“Seek for the Things of a Better World”

Instructions: Fill in the blank puzzle grid using the word bank with the bold words from the scripture below. Place the words in the correct place on the grid.

Mosiah 18:8–9

And it came to pass that he said unto them: Behold, here are the **waters** of Mormon (for thus were they called) and now, as ye are **desirous** to come into the **fold** of God, and to be called his **people**, and are **willing to bear** one another’s **burdens**, that they may be **light**; Yea, and are willing to **mourn** with those that mourn; yea, and **comfort** those that stand in **need** of comfort, and to **stand** as **witnesses** of God at **all times** and in **all things**, and in **all places** that ye may be in, even until **death**, that ye may be **redeemed** of God, and be **numbered** with those of the **first resurrection**, that ye may have **eternal life**—

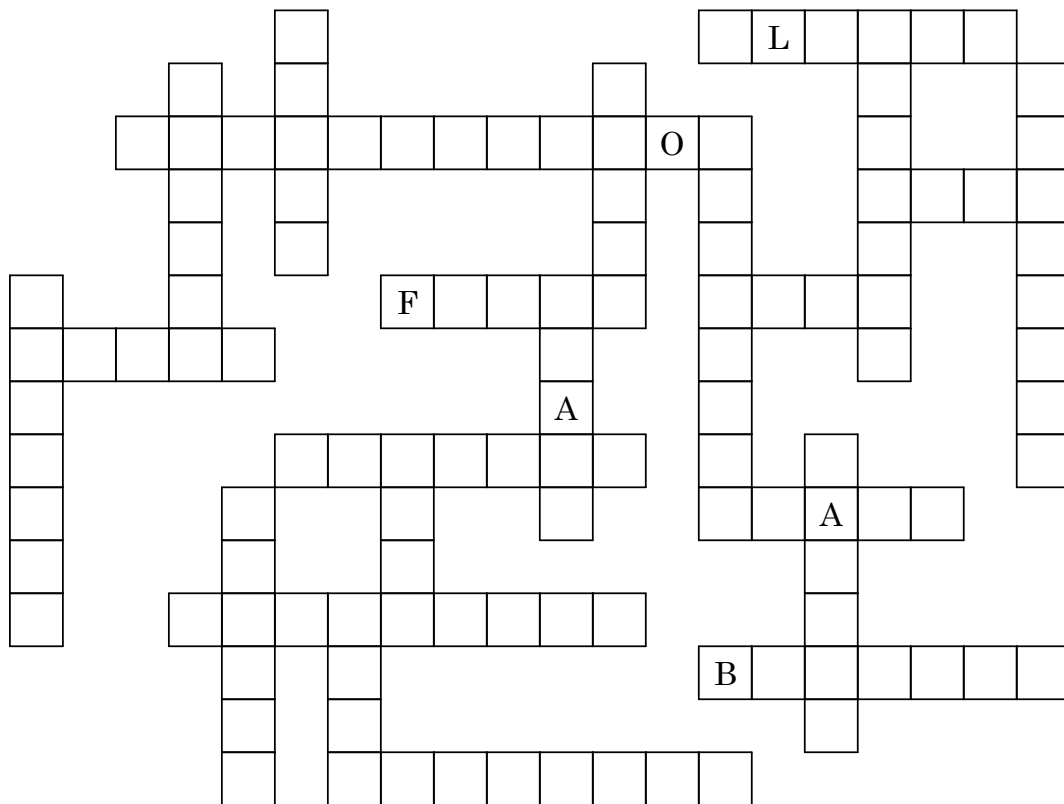

4 Letters

life
bear
fold
need

5 Letters

stand

first

light
times
mourn
death

6 Letters

people

places

things
waters

7 Letters

willing
eternal
comfort

burdens

8 Letters

numbered
redeemed
desirous

9 Letters

witnesses

12 Letters

resurrection

March 24–30

Doctrine and Covenants 27–28

“All Things Must Be Done in Order”

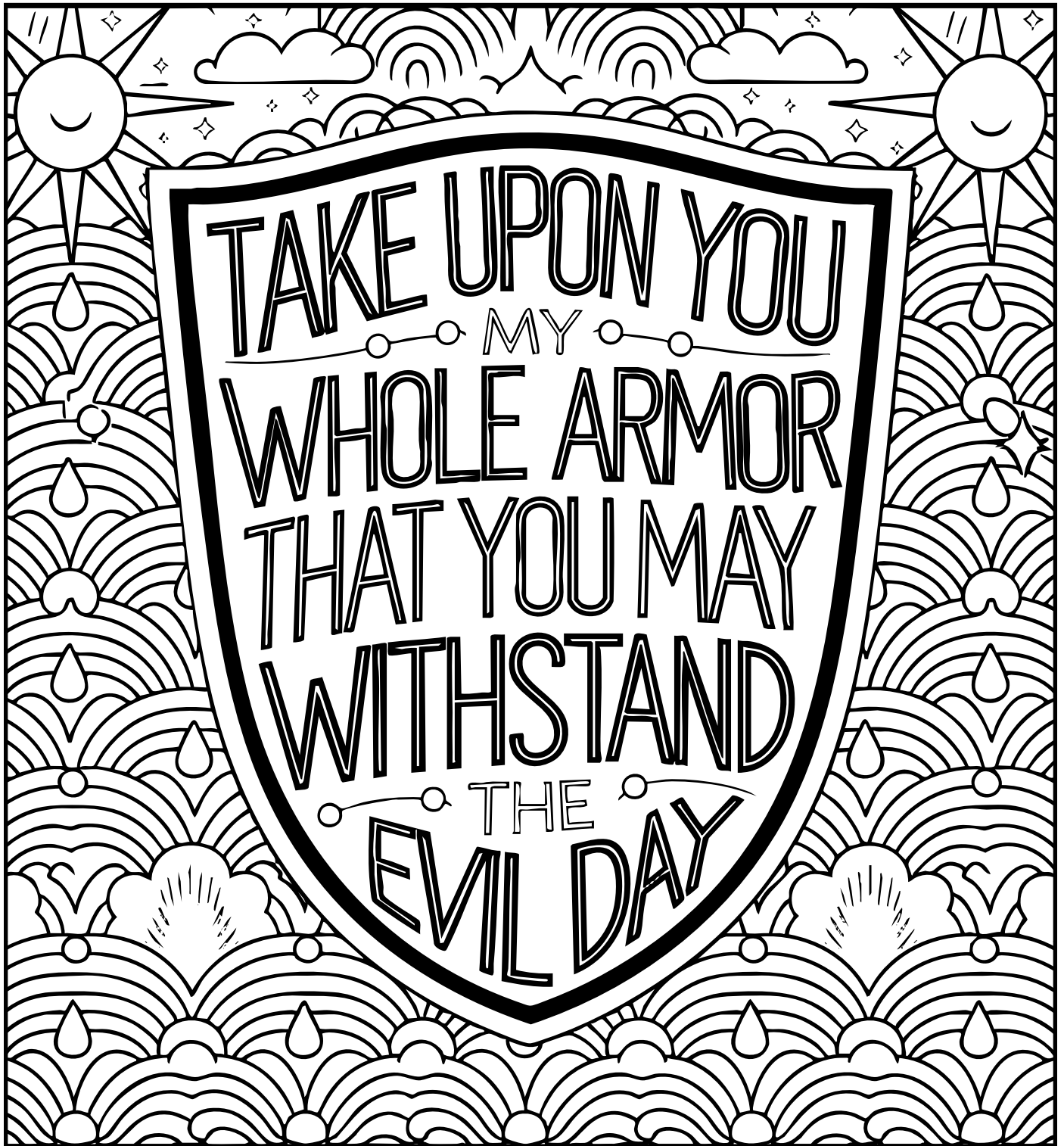

Doctrine and Covenants 27:15

March 24–30

Doctrine and Covenants 27–28

“All Things Must Be Done in Order”

Word Search

Instructions: Find the bold words from the scripture in the word search puzzle. Each word could be hidden forwards, backwards, up, down, or diagonally.

Doctrine and Covenants 28 section heading

Hiram Page, a member of the Church, had a certain **stone** and **professed** to be **receiving revelations** by its aid concerning the **upbuilding** of **Zion** and the **order** of the **Church**. Several **members** had been **deceived** by these claims, and even **Oliver Cowdery** was **wrongly influenced** thereby. Just prior to an appointed conference, the **Prophet inquired earnestly** of the Lord **concerning** the **matter**, and this revelation **followed**.

P E K N M W O Y H K I Y A W P
S N P G D E B O C G N O M R N
R O P R N B Z S R O F L A O F
E T U R O I I I U O L I R N R
B S Q P O F V R H A U V I G I
M E C S B P E I C O E E H L N
E A O D D U H S E A N R H Y Q
M R N E K O I E S C C D L P U
X N C V W P M L T E E L N N I
M E E I R R Z O D Z D R F H R
A S R E V E L A T I O N S P E
T T N C E D P B N K N C F A D
T L I E X R E O Y H J G G G M
E Y N D M O I F O L L O W E D
R D G X R Z A C C O W D E R Y

Knight Moves - Find a Word

Instructions: Start with any letter in the puzzle to see if it's the beginning of a word. To get to the second letter, jump two squares in any direction except diagonally, and then one square in a different direction. Your path will look like a capital L. Only one route through the puzzle will make a word. Write the letters of the word you discover in the blanks below as you jump through the squares:

1 2 3 4 5 6 7 8

Now can you find this word in one of the headings of this week's Come, Follow Me lesson?

e	e	r
e		v
i	s	c

March 24–30

Doctrine and Covenants 27–28

“All Things Must Be Done in Order”

Handwriting Practice

Practice your handwriting by tracing the sentence below. Then use the blank lines to write the sentence on your own.

The armor of God protects me.
The armor of God protects me.

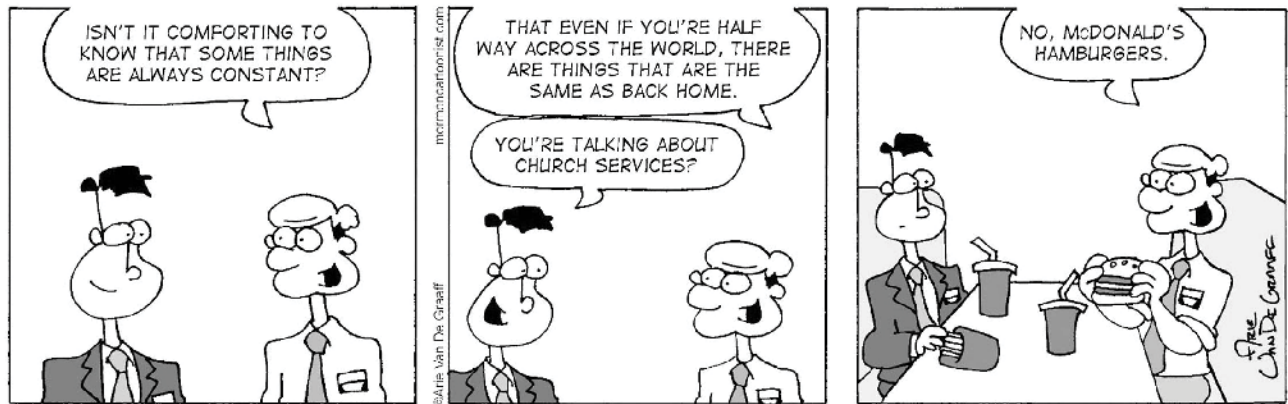

March 24–30

Doctrine and Covenants 27–28

“All Things Must Be Done in Order”

The sacrament helps me remember Jesus Christ.

Come, Follow Me 2025 Manual

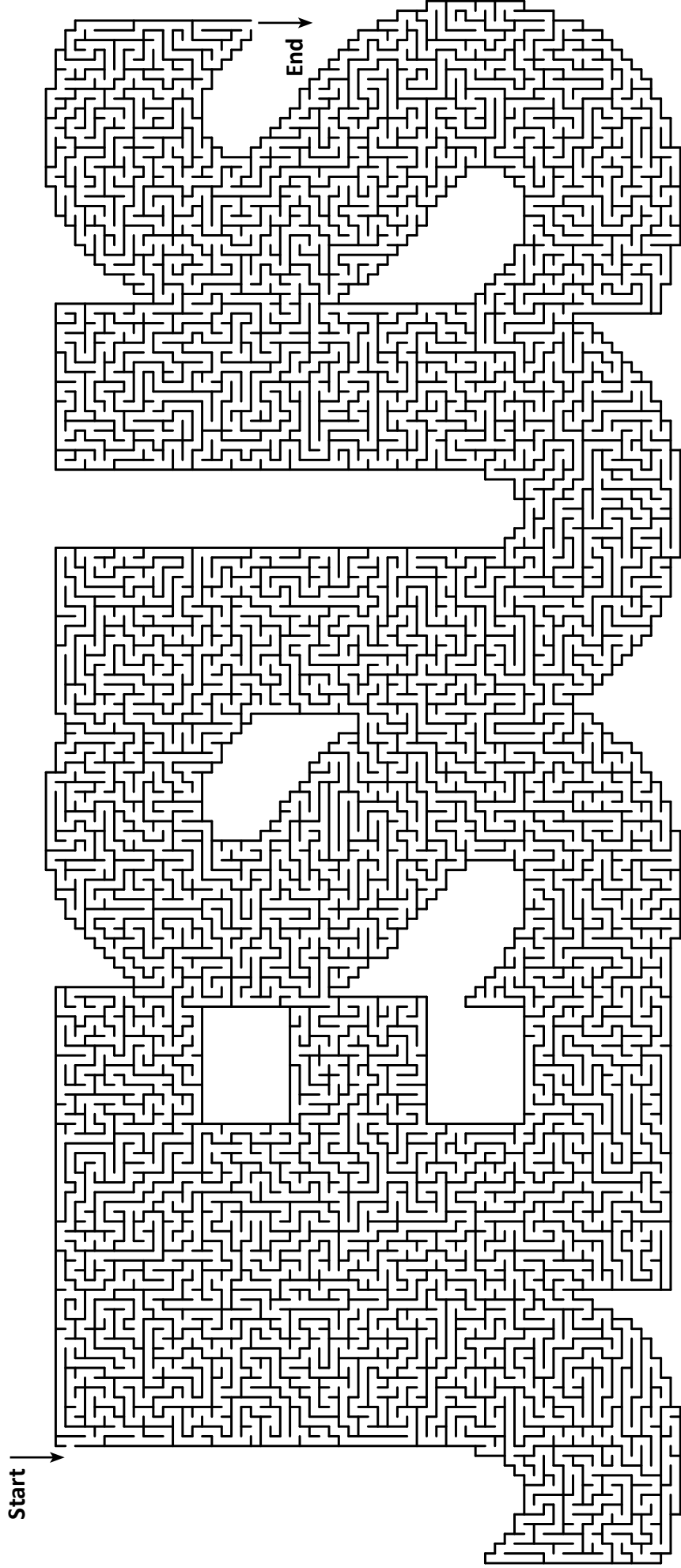

March 24–30

Doctrine and Covenants 27–28

“All Things Must Be Done in Order”

Reverse Word Search

Instructions: Instead of looking for words in a grid, place the bold words in the scripture in the empty word search puzzle. The words may be forwards, backwards, up, down, or diagonally. The start letter of the words have been placed in the grid to get you started.

Doctrine and Covenants 28:2

But, **behold, verily, verily, I say** unto thee, no one shall be **appointed** to **receive commandments** and **revelations** in this **church** **excepting** my **servant Joseph Smith, Jun.**, for he **receiveth** them **even** as **Moses**.

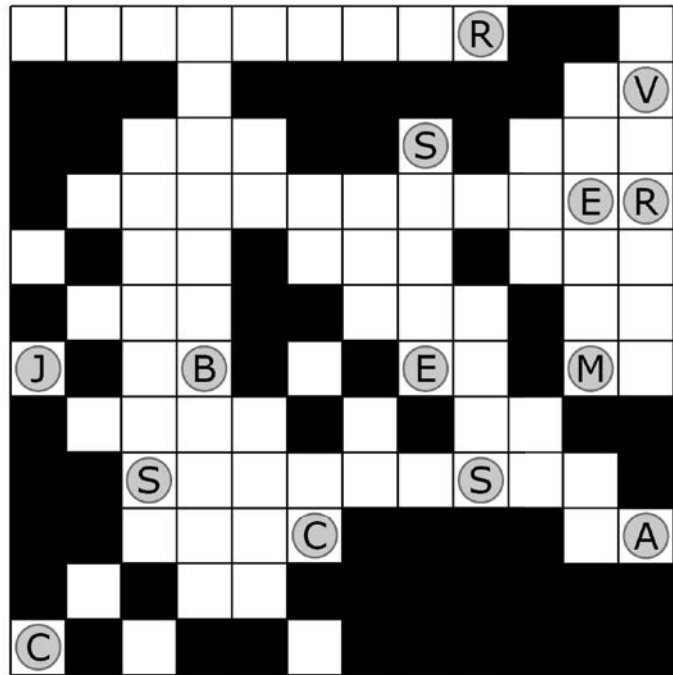

Cryptogram

Instructions: Each letter on the top stands for a letter in the alphabet. Solve the encrypted phrase by matching each letter on top to a letter in the alphabet on the bottom. Use the key to help you remember what the letters stand for so you can crack the code.

P	M	T	W	X	J	K	U	I	R	G	O	N	F	V	B	Y	D	S	L	E	Q	Z	C	A	H
A	B	C	D	E	F	G	H	I	J	K	L	M	N	O	P	Q	R	S	T	U	V	W	X	Y	Z

T I S C U M C L C Z U O L I X U L N F U S H S

X Z J I S C , Q L H J T L J R , Q L H J K L R ,

Y M R Q L H J J U R U U B U J , D Z L S U D L J R

I S V H I X G Y M R A L D U J N H T .

R L X C J I M U Y M R X L O U M Y M C S 2 7 : 1

March 24–30

Doctrine and Covenants 27–28

“All Things Must Be Done in Order”

Word Sudoku

Instructions: Solve this word sudoku puzzle the same way that you’d solve a numeric sudoku. Each of the bold words in the scripture below is found once in every row, column and 3×3 box.

Doctrine and Covenants 28:6–7

And thou shalt not **command** him who is at thy **head**, and at the head of the **church**; For I have **given** him the **keys** of the **mysteries**, and the **revelations** which are **sealed**, until I shall appoint unto them another in his stead.

	revelations	mysteries			keys			
command		him				revelations		keys
				sealed		given		command
	head					command	church	him
		sealed	head					mysteries
		church			revelations	sealed		given
sealed			church			mysteries		
	him			keys	given		command	
		head	mysteries		command			sealed

March 31–April 6

Doctrine and Covenants 29

“Jesus Christ Will Gather His People”

Letter Sudoku

Instructions: Solve the letter sudoku puzzle the same way you’d solve a numeric sudoku. Check your puzzle against the answer key on ColorMeChristian.org. Every column, row, and group of nine must contain every letter in the word(s) **JUDGMENTS**.

Doctrine and Covenants 29:30

But remember that all my **judgments** are not given unto men; and as the words have gone forth out of my mouth even so shall they be fulfilled, that the first shall be last, and that the last shall be first in all things whatsoever I have created by the word of my power, which is the power of my Spirit. For by the power of my Spirit created I them; yea, all things both spiritual and temporal

	G	M				J		
				U	J	G		E
	E							
	J		M	G	D	E		T
D				J		U		
					M		N	U
M		U			G			
	T		U	D	S			

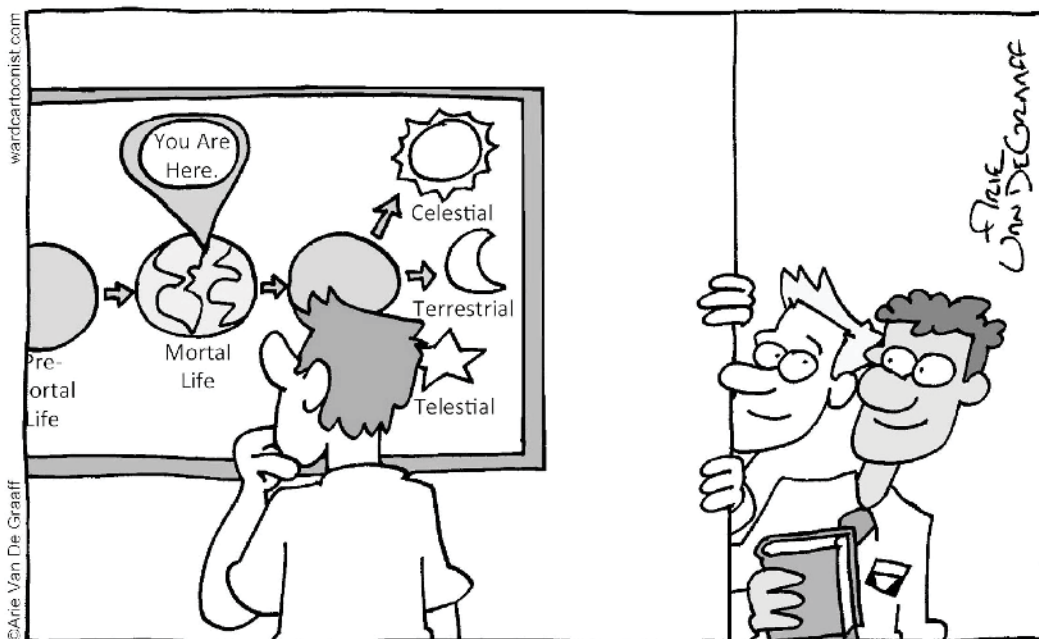

Hidden Picture: Jesus Christ is gathering His people before He comes again, just like a hen gathers her chicks under her wings. Can you find 3 copies of the hen and her chicks in the hidden picture below? It will be tricky; the pictures may be smaller, on their side, or even upside down! Then, see if you can find one copy of the animals as well.

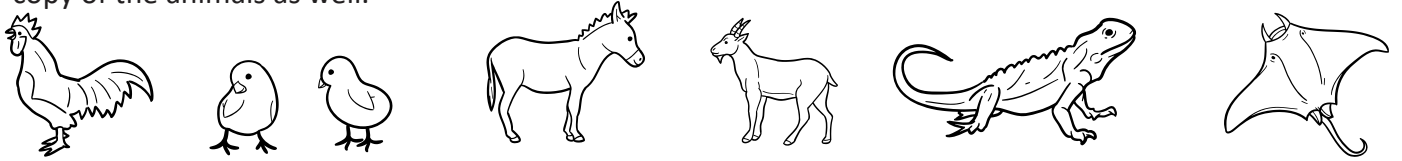

March 31–April 6

Doctrine and Covenants 29

“Jesus Christ Will Gather His People”

Missing Vowels Word Search

Instructions: Find the hidden words. The words have been placed horizontally, vertically, diagonally, forwards, or backwards, and the vowels have been removed. When you locate a word, draw an ellipse around it and fill the vowels in.

Doctrine and Covenants 29:7-8

And ye are called to **bring** to pass the **gathering** of mine **elect**; for **mine elect hear** my **voice** and harden not their **hearts**; Wherefore the **decree** hath gone **forth** from the **Father** that they shall be gathered in unto **one place** upon the **face** of this **land**, to **prepare** their hearts and be prepared in all **things** against the **day** when **tribulation** and **desolation** are sent **forth** upon the **wicked**.



Word Guess

Instructions: Write your word guesses in the puzzle below. For extra hints, look at the words/phrases in the scripture below. Check the answer on ColorMeChristian.org

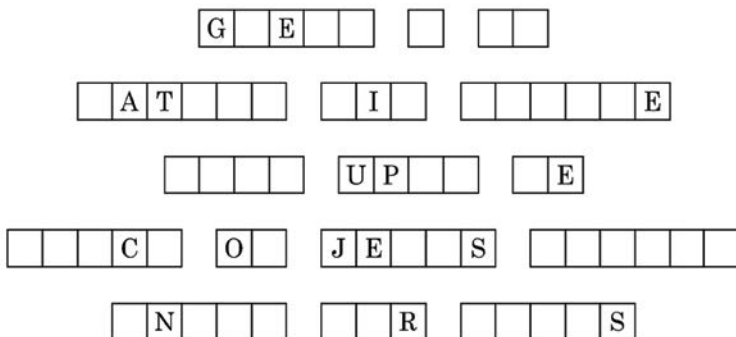

Doctrine and Covenants 29:1–2

Listen to the voice of Jesus Christ, your Redeemer, the Great I Am, whose arm of mercy hath atoned for your sins; Who will gather his people even as a hen gathereth her chickens under her wings, even as many as will hearken to my voice and humble themselves before me, and call upon me in mighty prayer.

Coming to Earth

Can you help these spirit children in the premortal existence come to earth and find their bodies at the end of the maze?

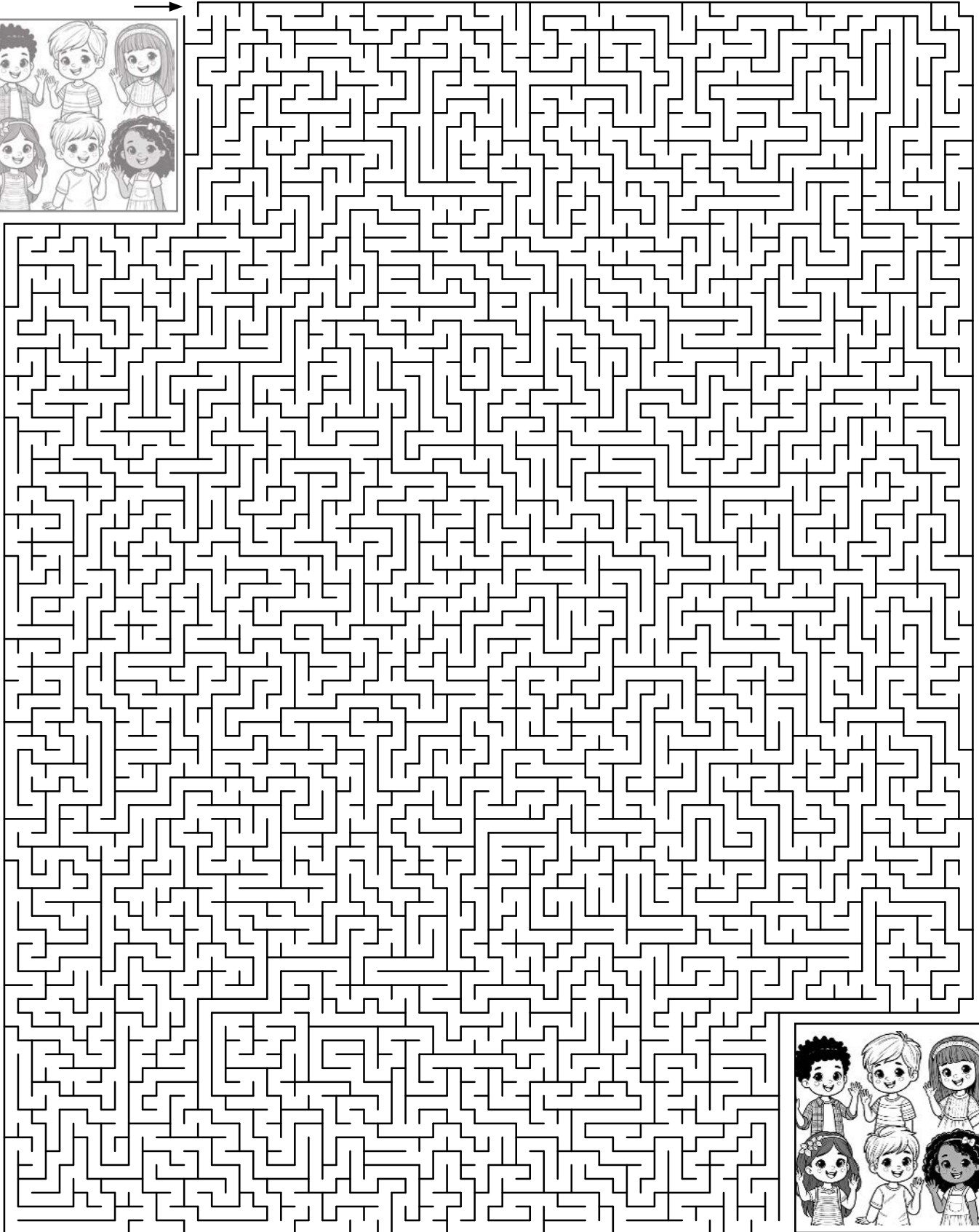

March 31–April 6

Doctrine and Covenants 29

“Jesus Christ Will Gather His People”

Translation Station

Instructions: Translate the sign language letters below into English to discover the hidden message. Write the alphabet letter beneath each hand sign. Use the key at the back of the book to help you.

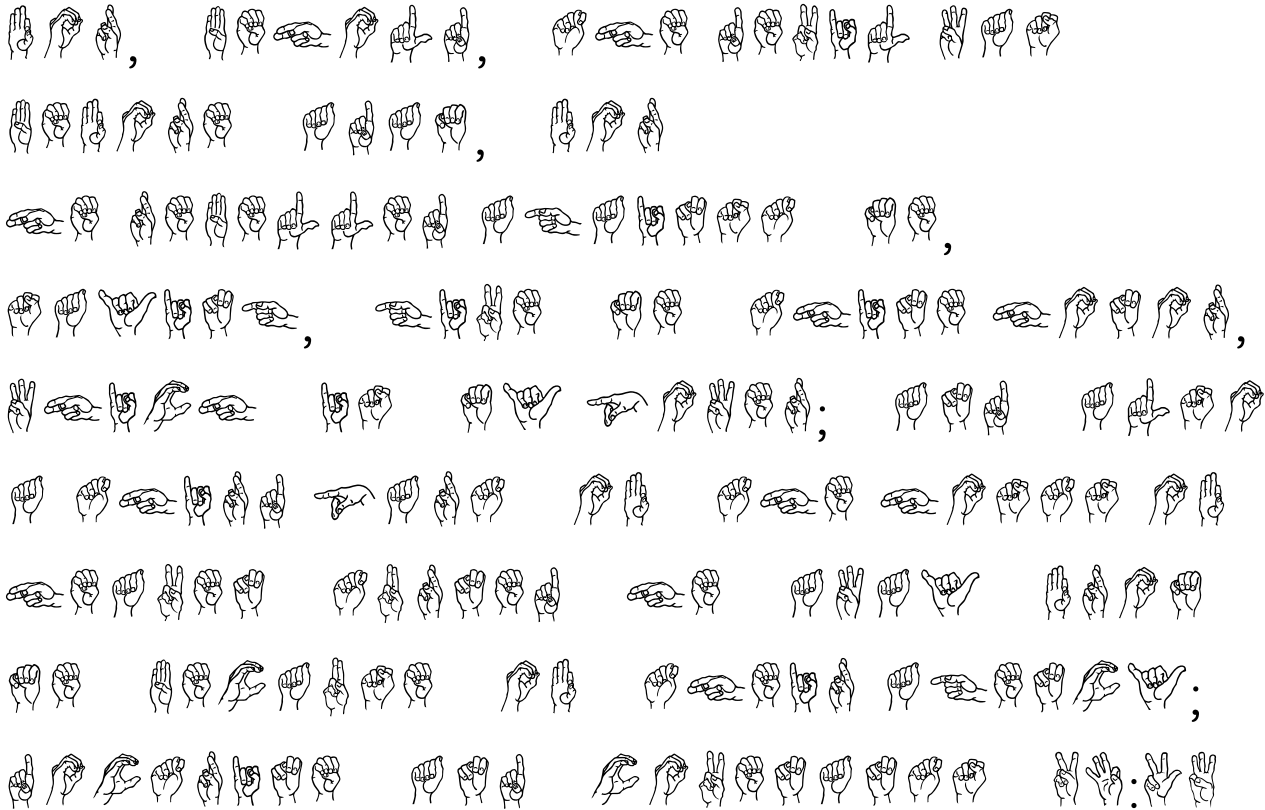

March 31–April 6

Doctrine and Covenants 29

“Jesus Christ Will Gather His People”

Instructions: Using the Across and Down clues, write the correct words in the numbered grid below. Hint: all of the words in the crossword come from the scripture below.

Doctrine and Covenants 29:1, 42–43

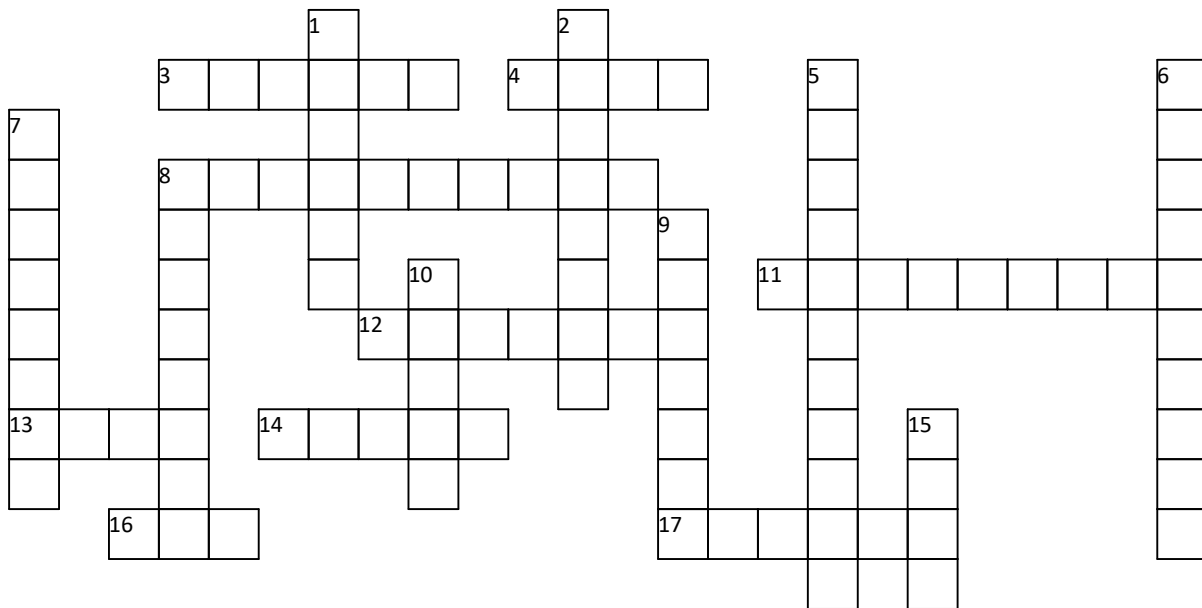

ACROSS

3. to reconcile man to God
4. children; descendents
8. the act of purchasing back something previously sold
11. a trial period during which one's abilities are tested
12. to have faith in someone or to accept something as true
13. the first man created on earth; the father and patriarch of the human race on the earth
14. the sound produced in a person's larynx and uttered through the mouth, as speech or song
16. an upper limb of the human body
17. hear with intention

DOWN

1. messengers from God
2. physically born
5. the condition of living forever in a resurrected state, not subject to physical death
6. turns away from evil and turns his heart and will to God
7. relating to worldly as opposed to spiritual affairs
8. He, through His Atonement, paid the price for the sins of mankind and made possible the resurrection of all people
9. continuing forever or indefinitely
10. the spirit of compassion, tenderness, and forgiveness
15. Willful disobedience to God's commandments.

April 7–13

Doctrine and Covenants 30–36

“Lift Up Your Voices ... to Declare My Gospel”

Fill in the Blank

Doctrine and Covenants 30:1–2

Behold, I say unto you, _____, that you have _____ man and have not _____ on me for _____ as you ought. But your _____ has been on the _____ of the _____ more than on the things of me, your _____, and the _____ whereunto you have been _____; and you have not given _____ unto my _____, and to those who were set _____ you, but have been _____ by those whom I have not _____.

Spirit	over	commanded	heed	feared	Maker
strength	mind	called	persuaded	things	relied
earth	ministry	David			

Word Square

Instructions: Word squares are a liike Sudoku puzzles, but each letter can occur only once in each row and in each column. Check your puzzle against the answer key on ColorMeChristian.org. Every row and column must contain every letter in the word **PREVAIL**. This word can be written in the gray row.

Doctrine and Covenants 33:12–13

Behold, verily, verily, I say unto you, this is my gospel; and remember that they shall have faith in me or they can in nowise be saved; And upon this rock I will build my church; yea, upon this rock ye are built, and if ye continue, the gates of hell shall not **prevail** against you.

		V			R	E
E	P	A	L			R
				V		P
V	I		E	R		
		R	A			I
	L	P			A	V

April 7–13

Doctrine and Covenants 30–36

“Lift Up Your Voices ... to Declare My Gospel”

Wacky Word Trails

Instructions: Start with the circled letter, use the clues to find and mark the trail of letters of all the connected bolded words from the scripture through the maze to the last letter. The path can wander up, down, left, and right at any point, even in the middle of the word.

Doctrine and Covenants 33:8–10

Open your **mouths** and they shall be **filled**, and you shall **become** even as **Nephi** of old, who **journeyed** from **Jerusalem** in the **wilderness**. Yea, open your mouths and **spare not**, and you shall be **laden** with **sheaves** upon your **backs**, for lo, I am **with** you. Yea, open your mouths and they **shall** be filled, saying: **Repent**, repent, and **prepare** ye the **way** of the **Lord**, and **make** his **paths** **straight**; for the **kingdom** of heaven is at **hand**;

D B F X N B F W M Z E P A A L L
G O D T J T P **S** E A N D T H S J
F K U P H N A R E H H T H S S O
Z E F R Z Q I E L A D I W B K U
T R Z D R Q X A M N E G I A C R
Z F P U F N B K O T E P H Y E N
T V X O P E P E N S N S W E D B
Y C N S C N U S S H E E P E M E
N L D S E W Z E M I A V R W O C
M I E R N D G W D Q R P E C G Y
T W E H M O N K O Z M A F I I D
H G A V M K I G R E J R E L L I
I I A E E L A S U C D R C D E R
S T R N G F P L I Z Y O L W A Y
S J J M Z B D L J P W S T N E R
H T U O G Y T S D C O O H J P E

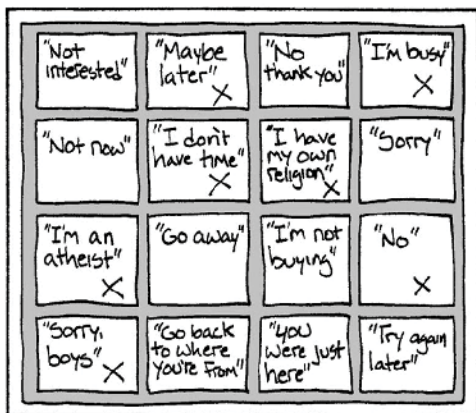

Harmony Hidden Picture

By Arië Van De Graaff

An important power was restored to Joseph Smith and Oliver Cowdery in a beautiful wooded area near Harmony, Pennsylvania, in 1829. Write the first letter of each animal in the spaces below. The letter "T" for insects has been filled in for you. Unscramble the letters to find out what this important power is.

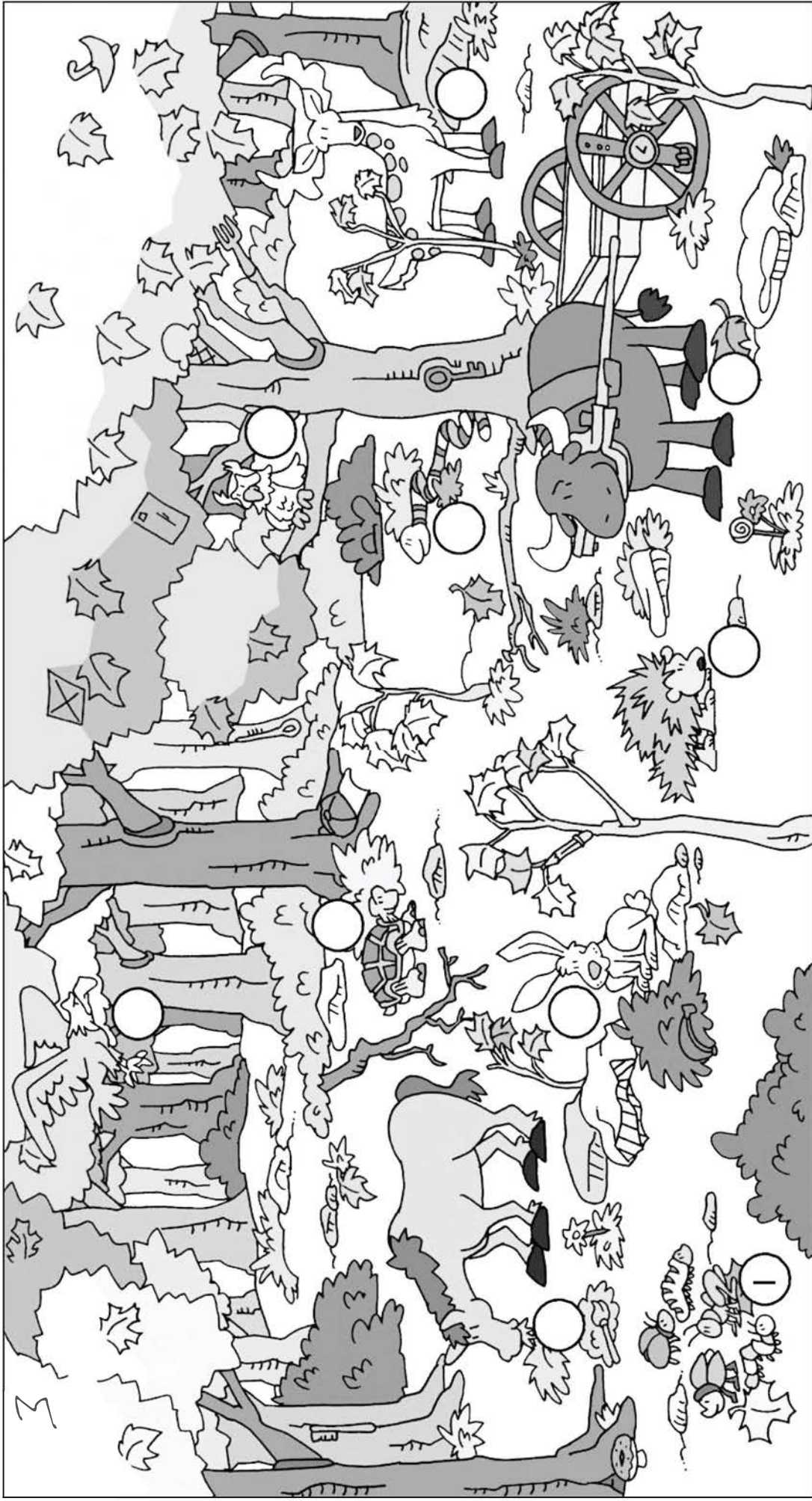

Can you also find these items in the picture?

April 7–13

Doctrine and Covenants 30–36

“Lift Up Your Voices ... to Declare My Gospel”

Instructions: Connect all of the letters in the maze and then write the phrase in the blanks below. Don't be tricked by letters that take you into a dead end! There is only one path through the maze.

-----,-----
-----,-----
-----.

Doctrine and Covenants 33:8

A	S	U	R	E	J	M	O	R	F	R	L	A	S	U	R	U	S	A	L	E	M	I	L
S	U	R	E	J	M	O	R	F	D	F	R	O	M	R	E	R	A	L	I	M	I	W	I
B	S	U	R	E	O	R	F	D	E	D	F	R	O	M	J	E	M	E	N	T	H	E	W
L	L	L	U	O	R	F	D	E	Y	O	R	O	M	J	U	R	I	W	T	H	E	W	I
L	A	H	S	L	A	R	F	D	E	Y	O	M	J	E	S	U	W	E	H	E	W	I	L
A	H	S	Y	S	H	O	R	E	N	E	Y	R	E	R	U	S	I	W	E	L	I	E	R
H	S	Y	E	Y	S	Y	E	N	R	N	E	Y	R	U	S	E	N	I	W	I	L	D	E
S	Y	E	H	E	Y	S	N	R	U	R	N	E	Y	E	D	N	R	E	I	L	D	E	N
Y	E	H	T	Y	E	Y	S	U	O	U	R	N	E	Y	E	R	E	D	L	D	S	N	E
E	H	T	D	T	H	E	U	O	J	O	U	R	N	E	Y	N	R	E	D	N	E	O	P
D	N	A	N	D	T	H	W	H	O	J	R	U	E	Y	S	E	N	R	E	R	S	S	O
N	A	S	D	T	H	E	D	W	H	O	J	O	Y	E	S	S	E	N	R	N	E	S	S
A	S	H	S	H	S	Y	L	D	W	H	O	J	O	U	O	S	S	E	N	S	S	P	O
S	H	T	H	A	H	F	O	L	D	O	J	O	U	R	N	O	S	S	E	O	S	E	P
H	T	U	S	A	A	O	L	D	W	H	O	U	R	S	A	S	O	S	S	P	O	N	E
T	U	O	A	L	L	I	O	F	O	L	S	A	S	A	N	A	P	O	S	E	P	Y	O
H	O	M	O	B	L	H	I	O	L	S	A	N	E	V	E	S	N	P	O	N	E	O	U
O	U	R	F	E	B	P	H	L	D	A	N	E	V	E	V	E	V	E	N	Y	N	Y	R
M	R	U	R	M	E	E	N	S	A	N	E	V	E	E	M	E	E	V	A	O	Y	O	M
O	U	O	U	I	F	N	S	A	N	E	V	E	E	M	O	M	E	E	V	E	N	A	S
U	O	Y	R	L	I	E	N	S	A	N	E	V	E	E	C	O	M	E	E	N	A	S	N
P	U	N	Y	L	L	L	A	H	S	L	A	E	O	C	E	C	O	M	E	E	N	A	S
O	P	E	O	E	L	E	D	O	U	S	H	N	M	O	B	E	C	O	M	V	E	N	A
P	Y	N	Y	D	E	N	D	Y	O	U	S	H	A	M	L	B	E	M	E	E	V	E	N
E	O	Y	N	A	D	A	N	D	Y	O	U	S	H	A	L	L	C	O	M	E	E	V	E

Finish

Start

April 14–20

Easter

“I Am He Who Liveth, I Am He Who Was Slain”

Word Spiral

Instructions: Fill in the blank puzzle grid using the bold words from the scripture or phrase below. *The bold words may not all be used!* Use the letter hint below and count the letters of the bold words to figure out where each word goes. Then transfer the letters that have little numbers in their box to the hidden word at the bottom of the puzzle. Check the answer on ColorMeChristian.org.

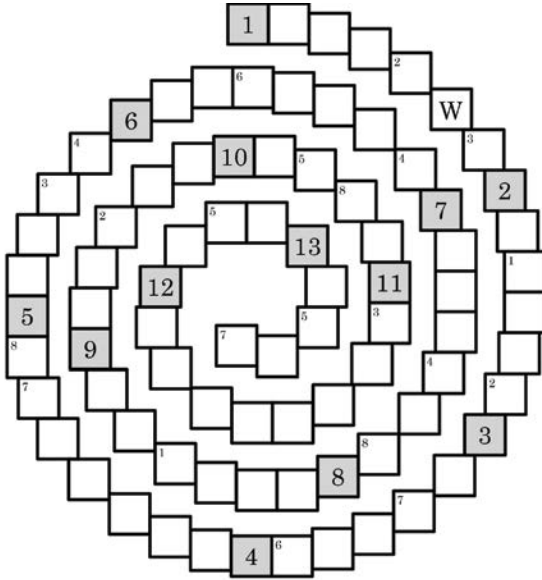

Doctrine and Covenants 138:17

Their **sleeping dust** was to be **restored** unto its **perfect frame**, **bone** to his bone, and the **sinews** and the **flesh** upon them, the **spirit** and the **body** to be **united never** again to be **divided**, that they might receive a **fulness of joy**.

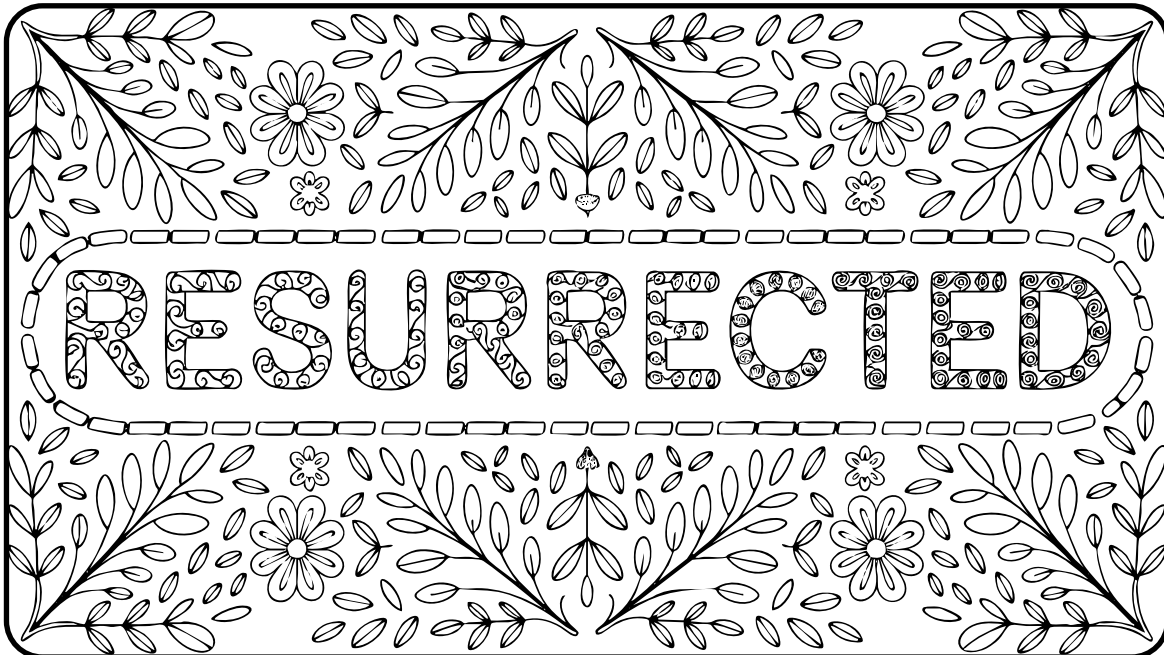
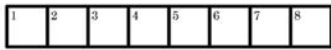

Because of Jesus Christ, I will be resurrected. (Come, Follow Me 2025 Manual)

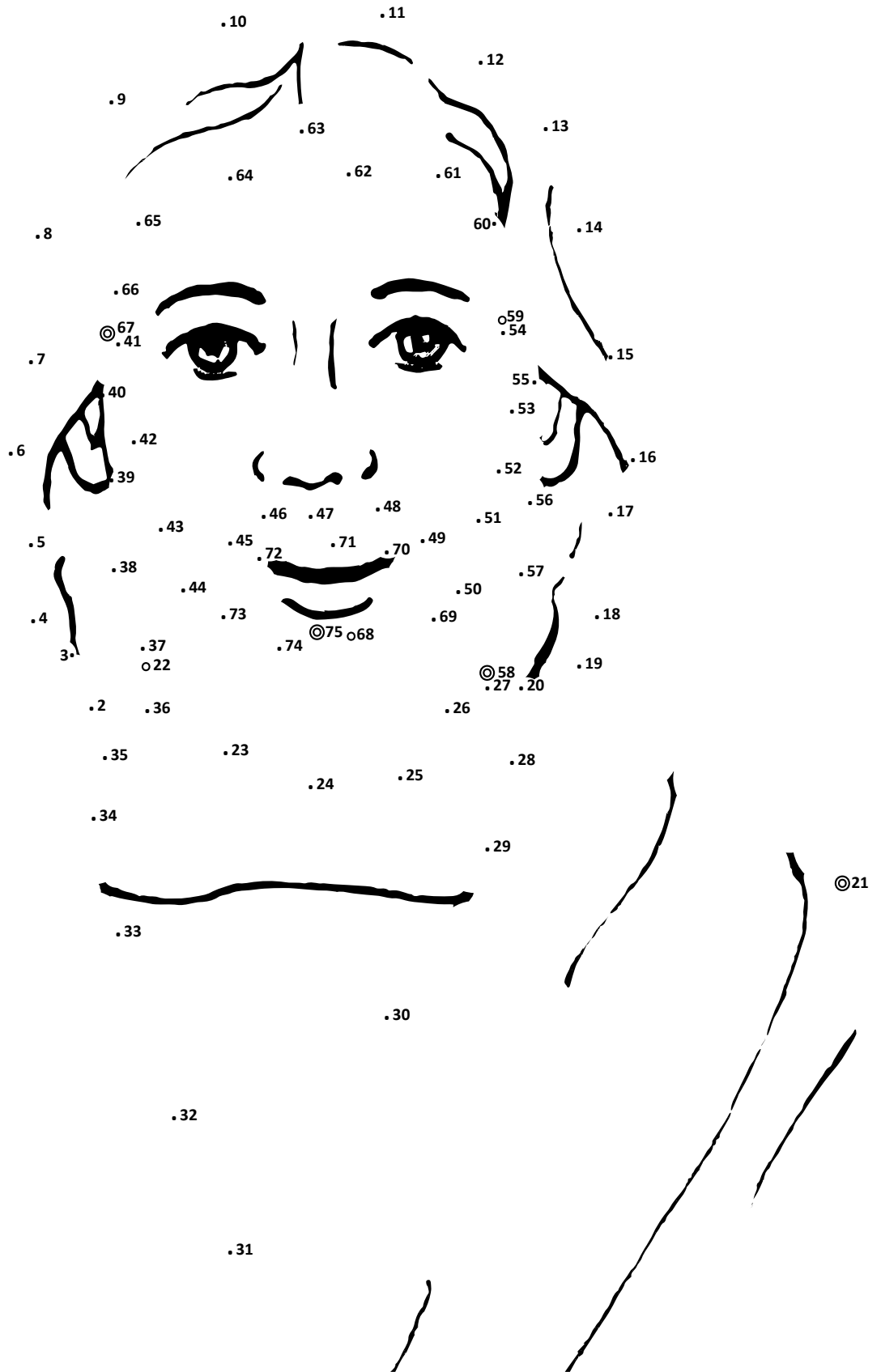

Key

- Stop. Pick up your pencil and go to the next dot.
- ◎ Start. Put your pencil down and draw the next line.

April 14–20

Easter

“I Am He Who Liveth, I Am He Who Was Slain”

Word Angles

Instructions: Find the bold words from the scripture. Each word path may run north, east, south, or west, may make one right-angled turn, and may cross another word path. A few words may make no right angle turn at all.

Doctrine and Covenants 19:16–19

For behold, I, God, have **suffered** these things for **all**, that they might **not** suffer if they would **repent**; But if they would not repent they must suffer even as I; Which suffering caused **myself**, even God, the **greatest** of all, to **tremble** because of **pain**, and to **bleed** at **every pore**, and to suffer both **body** and **spirit**—and would that I might not **drink** the **bitter cup**, and **shrink**— Nevertheless, **glory** be to the **Father**, and I **partook** and **finished** my **preparations** unto the **children** of men.

L	B	O	D	Y	M	P	M	Q	D	L	I	H	C	X	O
Z	Z	S	R	I	S	T	M	K	R	I	S	X	R	E	F
E	N	N	S	Z	T	L	H	E	G	H	K	V	T	S	
M	J	O	E	V	E	R	Y	G	N	I	R	I	N	K	E
X	B	I	T	A	R	A	P	E	R	P	S	O	D	U	T
L	B	X	P	K	Z	N	A	Q	X	N	V	R	E	R	A
L	A	U	Y	F	V	J	A	T	N	I	V	B	H	I	E
R	E	D	P	O	R	K	P	K	P	A	A	M	S	U	R
R	R	Y	T	W	E	N	O	R	W	U	O	Y	I	U	G
E	O	R	L	B	E	I	Y	E	F	L	E	S	N	I	F
P	D	O	E	N	M	R	P	T	T	I	B	H	T	A	F
E	T	L	E	P	T	D	B	L	T	I	A	E	N	N	B
N	T	G	D	A	R	Z	A	Y	Z	R	O	R	Y	G	V
K	O	O	T	R	E	Y	S	Q	Q	I	C	D	Y	T	C
V	F	E	L	B	M	B	U	L	H	P	P	M	N	O	U
O	O	D	E	R	E	F	F	S	N	S	V	B	L	C	P

Word Star

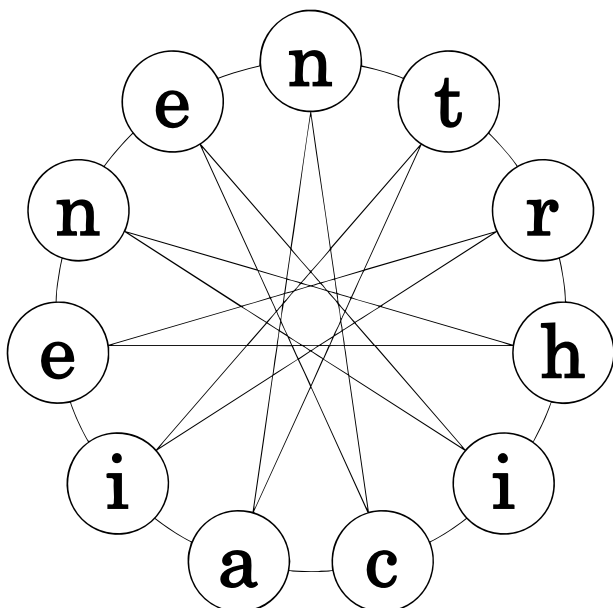

Instructions: Only one route through the word star will make a word. Try each letter and follow the pathway through the star to see if it makes a word.. IF you need a hint, look at the words in the scripture below. Write the letters of the word you discover in the blanks below as you travel through the star:

Now can you find this word in the following scripture?

Doctrine and Covenants 63:49

April 14–20

Easter

“I Am He Who Liveth, I Am He Who Was Slain”

Because of Jesus Christ, I can be forgiven of my sins.

Come, Follow Me 2025 Manual

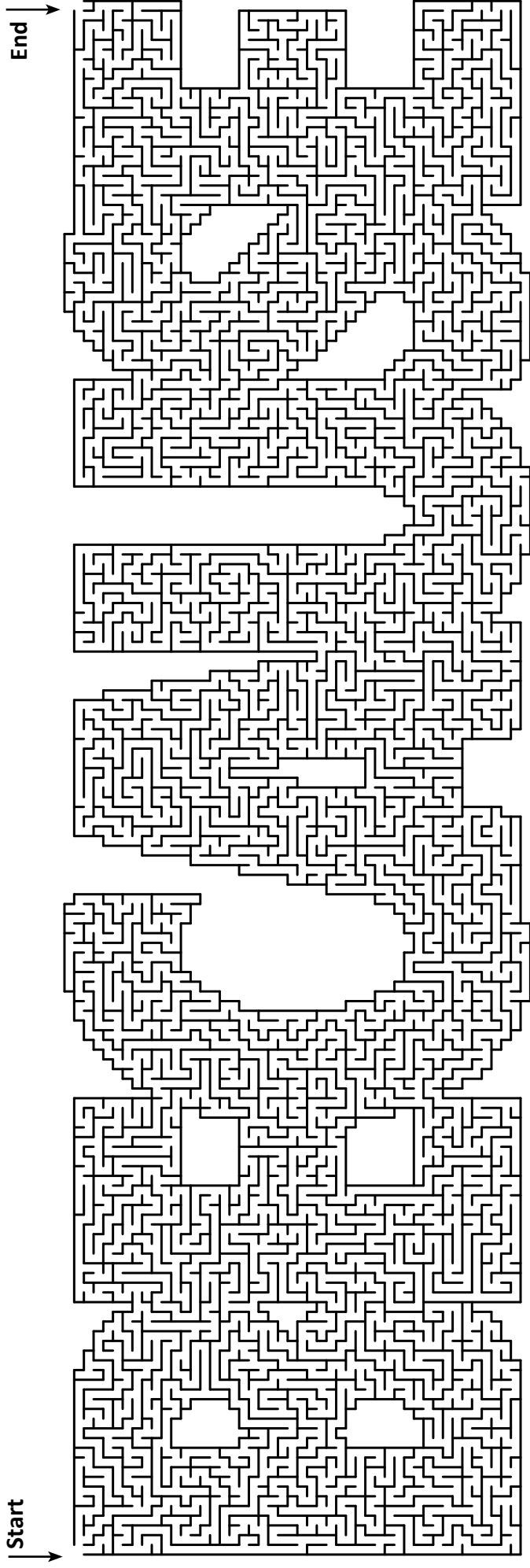

April 14–20

Easter

“I Am He Who Liveth, I Am He Who Was Slain”

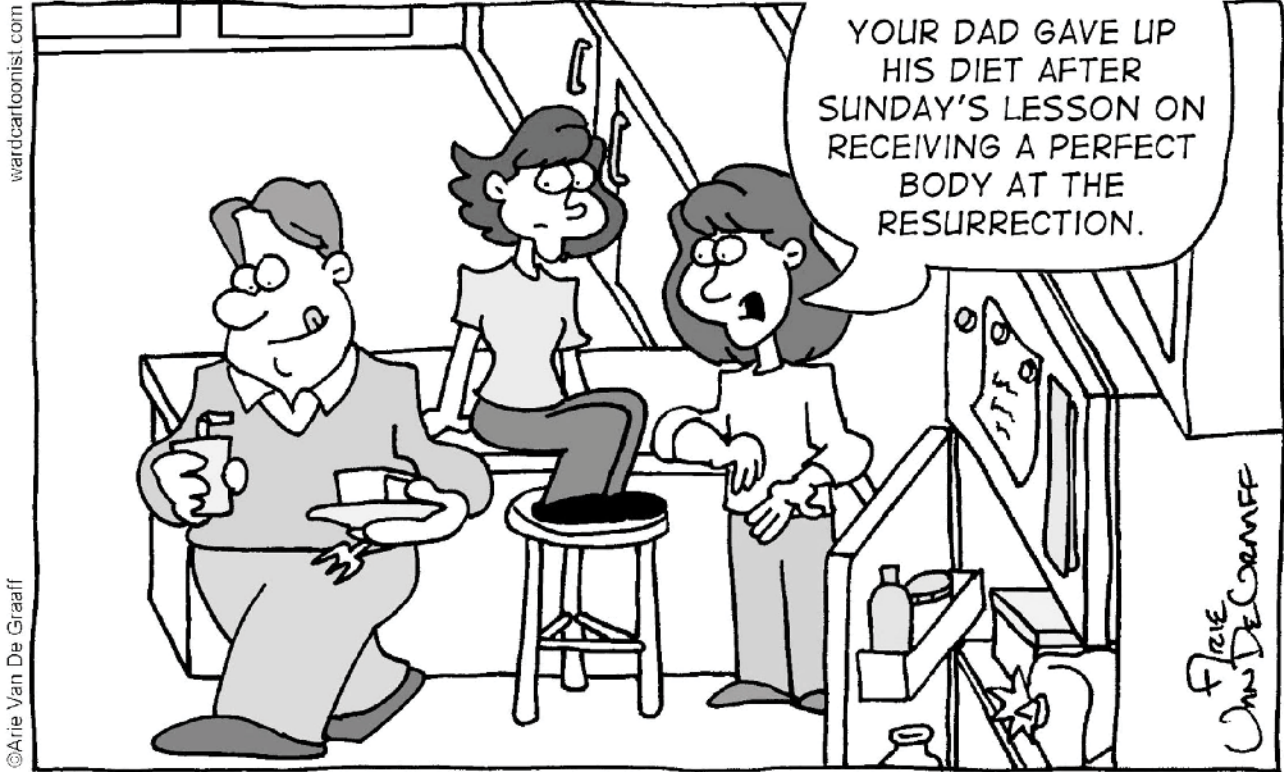

Letterbox Puzzle

Instructions: Find the hidden word in the puzzle below by crossing out all letters that occur twice or more. Capitalized and lowercase letters count as unique letters for this puzzle. The letters left over will form a word. Write down the left over letters like you would read a book, from left to right and top to bottom. Then find the hidden word in the scripture or phrase below and circle it.

Doctrine and Covenants 45:3–5

Listen to him who is the advocate with the Father, who is pleading your cause before him—Saying: Father, behold the sufferings and death of him who did no sin, in whom thou wast well pleased; behold the blood of thy Son which was shed, the blood of him whom thou gavest that thyself might be glorified; Wherefore, Father, spare these my brethren that believe on my name, that they may come unto me and have everlasting life.

Write the hidden word:

z	W	a	K	V	D
v	d	Q	z	U	o
V	U	c	Y	S	Y
E	S	H	A	K	W
†	H	n	J	Q	d
E	g	n	e	J	g

April 21–27

Doctrine and Covenants 37–40

“If Ye Are Not One Ye Are Not Mine”

Word Search

Instructions: Find the bold words from the scripture in the word search puzzle. Each word could be hidden forwards, backwards, up, down, or diagonally.

Doctrine and Covenants 39:6, 23

And this is my gospel—**repentance** and **baptism** by **water**, and then cometh the baptism of **fire** and the Holy Ghost, even the **Comforter**, which **showeth all things**, and **teacheth** the **peaceable** things of the **kingdom**....And again, it shall come to pass that on as many as ye shall baptize with water, ye shall **lay** your **hands**, and they shall **receive** the **gift** of the **Holy Ghost**, and shall be **looking** forth for the **signs** of my **coming**, and shall **know** me.

H E B O V M O D G N I K W S I
A V A T S I G N S U Y S G U V
N I P T E A C H E T H N Q F N
D E T C I H E C W O I C F H L
S C I W A X O T W H T Z U U C
G E S T Q M F E T J U X A R O
B R M N I I T A U D I T E F M
M Q D N G H A P B J I P T L F
E R G Z R R U Y O U E W S Z O
Y L O H D E L A Y N O N O B R
Z V T F I T F Q T N V I H B T
A F I R E A Y A K S R O G H E
Q L Z E S W N G N I K O O L R
W L L F F C C X I G O M A D F
P E A C E A B L E G E N U J U

Knight Moves - Find a Word

Instructions: Start with any letter in the puzzle to see if it's the beginning of a word. To get to the second letter, jump two squares in any direction except diagonally, and then one square in a different direction. Your path will look like a capital L. Only one route through the puzzle will make a word. Write the letters of the word you discover in the blanks below as you jump through the squares:

1 2 3 4 5 6 7 8

Now can you find this word in the following scripture?

Doctrine and Covenants 38:24–25

t	r	c
e		c
a	i	p

Working Together in Palmyra

By Arie Van De Graaff

Each person in this picture has one thing in common with one other person. (Hint: It could be the same kind of hat, apron, or hairstyle.) Start with the person next to the letter "F." Write "F" in the first blank below. Then find the person who is wearing the same hat as person "F." Write the letter for that person in the next blank. Continue on until you have filled in all the blanks to spell out two words that tell about the people in the picture.



April 21-27

Doctrine and Covenants 37-40

"If Ye Are Not One Ye Are Not Mine"

wardcartoonist.com

©Arie Van De Graaff



Secret Code

Instructions: The secret message is written in symbols. In the code key you can find what each symbol means. Write the letter above the symbol and you can read the secret message.

a	b	c	d	e	f	g	h	i	j	k	l	m
□	◇	△	▱	⬡	▷	▽	⊗	◀	∇	▽	▶	▴
n	o	p	q	r	s	t	u	v	w	x	y	z
◁	▯	▽	▮	○	▭	⋈	⊗	⊞	▾	◀	△	Σ

◁⊗◁▷' ▭⊗⊗ ⊞ ⊗⊞⊞ ▭⊗⊞ ⊗⊗
 ▽⊗ ⊞ ⊞ ▭⊗⊞⊗▷' ◁⊗ ⊞ ⊞ ⊞ ⊞⊞
 ⊞ ⊞ ⊞' ⊞ ▭⊗⊞ ⊗⊗ ▽⊗' ⊗ ⊞⊗'
 ◁⊗ ⊞ ⊞ ⊞ ⊞⊞ ⊗⊗ ⊞⊞ ⊞ ⊞⊞ ⊗⊗
 ▭⊗⊞' ▭⊗⊞⊗⊗⊗ ⊞⊗ ▽⊞⊞⊗⊗⊗⊗

April 21–27

Doctrine and Covenants 37–40

“If Ye Are Not One Ye Are Not Mine”

Instructions: Using the Across and Down clues, write the correct words in the numbered grid below. Hint: all of the words in the crossword come from the scripture below.

Doctrine and Covenants 38:24–27

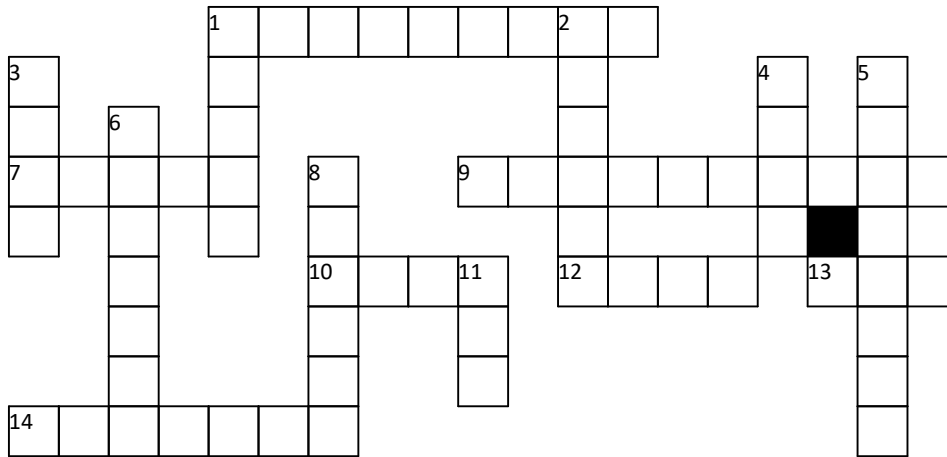

ACROSS

- Someone who treats people according to their rank, status or importance
- to devote one's life or efforts to someone, such as the Lord
- in a spiritual sence, doing God's will"
- clothes usually in poor condition
- that which belongs to me
- being a single unit or thing
- a short moral story

DOWN

- any loose flowing garment
- respect and admiration, typically for a person
- acting or being in conformity with what is morally upright or good
- boys or men in relation to either or both of his parents
- spiritual and moral perfection; this is an indicator of the purity of a person's heart and intent
- a man or boy in relation to other sons and daughters of his parents
- integrity and moral excellence, power and strength
- take a seat

Gathering to the House of the Lord

God gathers us to bless us. Help this group of people through the maze so they can gather to the House of the Lord.

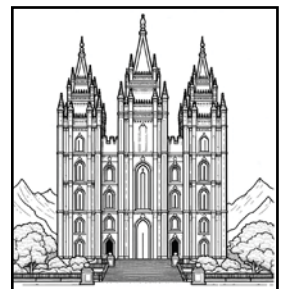
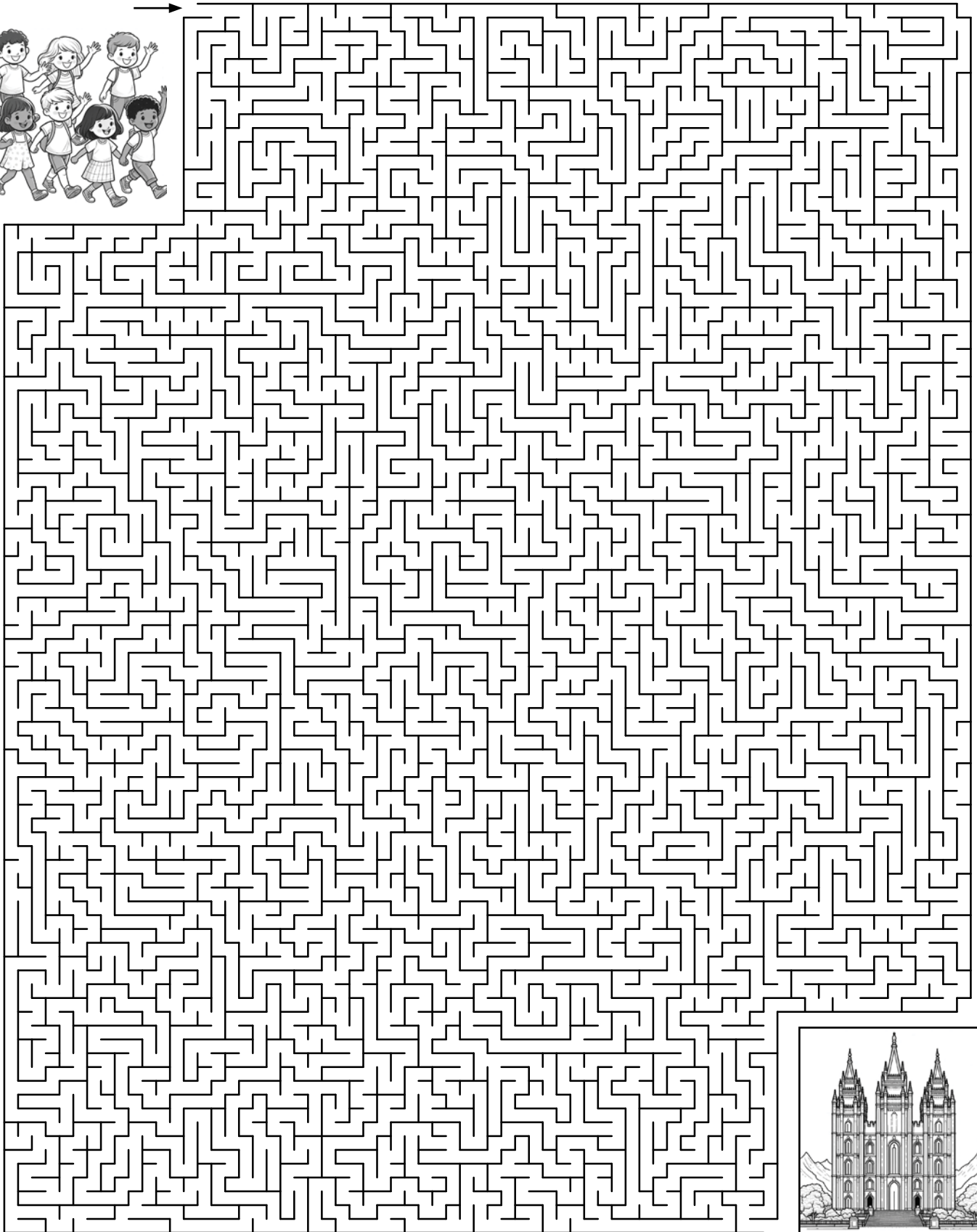

April 21–27

Doctrine and Covenants 37–40

“If Ye Are Not One Ye Are Not Mine”

Word Sudoku

Instructions: Solve this word sudoku puzzle the same way that you’d solve a numeric sudoku. Each of the bold words in the scripture below is found once in every row, column and 3×3 box.

Doctrine and Covenants 38:30

I tell you these things because of your prayers; wherefore, **treasure up wisdom** in your bosoms, lest the wickedness of men reveal these things unto you by their wickedness, in a manner which shall speak in your ears with a voice louder than that which shall shake the earth; but **if ye are prepared ye shall not fear**.

		prepared	wisdom			fear	are	
if	ye						prepared	treasure
are	shall		treasure				ye	
		shall		treasure	if		not	
		are		prepared	not			fear
		treasure	fear		wisdom			are
		not		fear	treasure		wisdom	
treasure	are			wisdom			fear	
fear	wisdom			ye	are			

April 28–May 4

Doctrine and Covenants 41–44

“My Law to Govern My Church”



Disciple
who will i
follow?

He that receiveth my law and doeth it,
the same is my disciple;
Doctrine and Covenants 41:5

April 28–May 4

Doctrine and Covenants 41–44

“My Law to Govern My Church”

Instructions: Connect all of the letters in the maze and then write the phrase in the blanks below. Don't be tricked by letters that take you into a dead end! There is only one path through the maze.

-----,
-----.

Doctrine and Covenants 42:2

R	K	E	K	N	U	E	U	I	Y	O	Y	O	T	N	U	Y	A	S	A	
A	E	A	R	V	I	V	L	G	O	T	O	T	N	U	Y	A	S	I	S	
U	H	E	A	I	G	I	L	L	T	N	U	N	U	Y	A	S	I	N	I	
O	U	H	E	G	L	G	A	L	A	L	E	U	Y	A	Y	I	N	I	N	
Y	O	U	H	L	L	A	H	S	H	A	V	Y	A	S	I	N	I	A	I	
O	Y	O	U	H	A	H	S	I	S	H	I	A	S	I	S	G	A	G	A	
T	O	Y	O	U	H	H	I	H	I	S	G	S	I	N	G	A	U	A	G	
N	U	O	Y	O	H	C	H	C	H	I	L	L	A	I	A	U	O	G	A	
U	Y	T	O	Y	O	I	H	I	C	H	L	A	H	A	G	O	Y	O	U	
Y	A	N	U	H	W	H	W	H	I	I	H	H	S	H	A	U	O	U	A	
A	S	U	Y	U	W	W	W	W	H	H	C	S	I	S	H	O	T	N	U	
S	I	S	A	W	A	W	A	W	H	C	I	C	H	H	N	U	E	V	E	
I	N	I	S	A	L	E	L	A	W	W	H	A	I	A	L	L	G	I	U	
S	I	N	I	S	E	H	T	Y	E	B	O	H	S	H	A	L	L	G	D	
I	A	I	N	I	H	T	Y	E	B	O	D	N	A	R	A	E	H	D	N	
Start	A	G	A	I	N	E	H	T	Y	T	B	O	D	N	A	R	A	E	H	A
G	A	I	N	T	N	U	N	T	O	Y	O	U	H	E	A	R	K	E	N	
A	I	S	I	S	A	Y	U	N	T	O	Y	O	U	H	E	A	R	K	E	

April 28–May 4

Doctrine and Covenants 41–44

“My Law to Govern My Church”

Translation Station

Instructions: Translate the Morse code below into English to discover the hidden message. Write the alphabet letter beneath each Morse Code letter. Each letter, number, and punctuation is separated by a slash: /. Use the key at the back of the book to help you.

• • - • / - - - / • - • /
• • / - • / • - / • • • / - - - / • • - / - • - • / • • • • /
• - / • • • / - • - - / • /
- • • / - - - / • • / - /
• • - / - • / - / - - - / - / • • • • / • /
• - • • / • / • - / • • • / - / - - - / • • - • /
- / • • • • / • / • • • / • / - - - • - - - /
- • - - / • / - • • / - - - / • • / - /
• • - / - • / - / - - - / - - - / • / • - • - • - - /
- • • / - - - / - • - • / - / • - • • / • • / - • • / • /
• - / - • / - • • /
- • - • / - - - / • • - / • / - • / • - / - • / - / • • • /
• • • • - / • • - - - / - - - • • • / • • • - - / - - - • • /

memorizationist.com

“I WILL GO AND DO THE THINGS WHICH THE LORD HATH COMMANDED, FOR I KNOW THAT THE LORD GIVETH NO COMMANDMENTS UNTO THE CHILDREN OF MEN, SAVE HE SHALL PREPARE A WAY FOR THEM THAT THEY MAY ACCOMPLISH THE THING WHICH HE COMMANDETH THEM.”

©Arlene Van De Graaff



GO FISH.



WIN OR LOSE, COMPANIONSHIP STUDY IS MORE FUN SINCE YOU INTRODUCED “SCRIPTURE MASTERY GO FISH.”

“ADAM FELT THAT MEN MIGHT BE; AND MEN ARE, THAT THEY MIGHT HAVE JOY.”



©Arlene Van De Graaff

April 28–May 4

Doctrine and Covenants 41–44

“My Law to Govern My Church”

Handwriting Practice

Practice your handwriting by tracing the sentence below. Then use the blank lines to write the sentence on your own.

I am happy when I obey the Lord.

Word Square

Instructions: Word squares are a liike Sudoku puzzles, but each letter can occur only once in each row and in each column. Check your puzzle against the answer key on ColorMeChristian.org. Every row and column must contain every letter in the word **GOSPEL**. This word can be written in the gray row.

I Want to Live the Gospel, Children’s Songbook

I want to live the **gospel**, To know
that its teachings are true, To
follow the plan of my Savior And
live as he wants me to do. I will
try in all I do and say To live the
gospel more each day. I will try in
all I do and say To live the gospel
more each day.

				L	
E		P			O
S				P	E
P		O			G
	S		G		

April 28–May 4

Doctrine and Covenants 41–44

“My Law to Govern My Church”

Instructions: Fit the bold words from the scripture below into the encircled squares. Words will read forward, backward, up, down, and diagonally and will normally cross other words. Start with the hints provided.

Doctrine and Covenants 43:3-4

And this ye shall **know assuredly**—that there is **none other appointed** unto you to **receive commandments** and **revelations** until **he** be **taken**, if he **abide** in me. But verily, verily, I say unto you, that none **else** shall be appointed unto this **gift except** it be **through him**; for if it be taken from him he shall not have **power except** to appoint **another** in his **stead**.

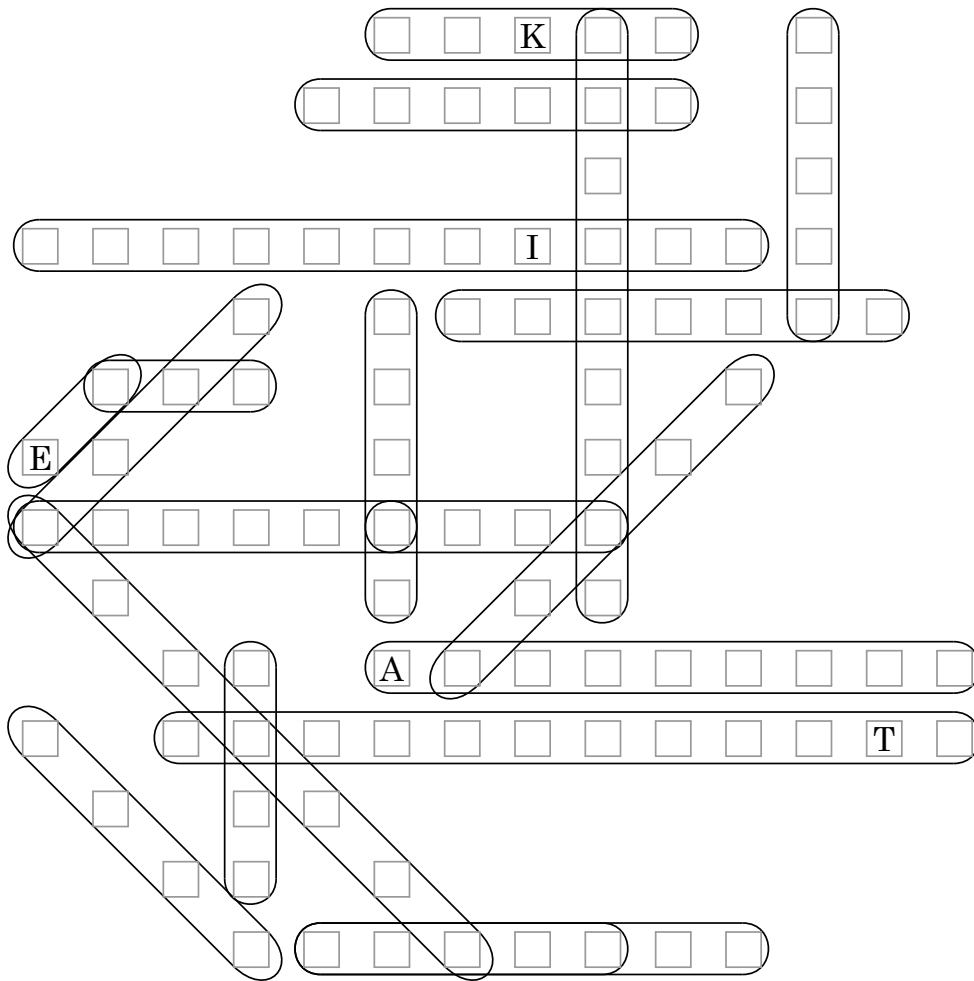

know
appointed
he
gift
power

assuredly
receive
taken
except
except

none
commandments
abide
through
another

other
revelations
else
him
stead

May 5–11

Doctrine and Covenants 45

“The Promises ... Shall Be Fulfilled”

Cryptogram

Instructions: Each letter on the top stands for a letter in the alphabet. Solve the encrypted phrase by matching each letter on top to a letter in the alphabet on the bottom. Use the key to help you remember what the letters stand for so you can crack the code.

L	A	M	P	C	Z	S	F	U	E	Q	D	W	H	B	V	I	R	K	J	G	O	N	X	T	Y
A	B	C	D	E	F	G	H	I	J	K	L	M	N	O	P	Q	R	S	T	U	V	W	X	Y	Z

̄Ō ̄Ī ̄Ȳ ̄C̄ ̄Z̄ ̄L̄ ̄Q̄ ̄Ḡ ̄Ē ̄Q̄ ̄D̄ ̄Ā ̄J̄ ̄Ḡ ̄Ḡ ̄N̄ ̄B̄ ̄Ā ̄Ā ̄Ḡ ̄Ȳ ̄B̄ ̄W̄ ̄L̄

̄Q̄ ̄W̄ ̄N̄ ̄V̄ ̄Ā ̄Z̄ ̄D̄ ̄Ā ̄B̄ ̄Ē ̄J̄ ̄Ḡ , ̄B̄ ̄W̄ ̄L̄ ̄Ḡ ̄N̄ ̄B̄ ̄Ā ̄Ā

̄W̄ ̄V̄ ̄Ȳ ̄Ō ̄J̄ ̄C̄ ̄V̄ ̄P̄ ̄J̄ ̄L̄ ; ̄Ō ̄Ī ̄Ȳ ̄B̄ ̄C̄ ̄V̄ ̄W̄ ̄Ū ̄Ȳ ̄N̄ ̄J̄

̄M̄ ̄Q̄ ̄Ē ̄S̄ ̄J̄ ̄L̄ , ̄C̄ ̄J̄ ̄W̄ ̄Ḡ ̄N̄ ̄B̄ ̄Ā ̄Ā ̄Ā ̄Q̄ ̄H̄ ̄Ȳ ̄Ī ̄D̄

̄Ȳ ̄N̄ ̄J̄ ̄Q̄ ̄R̄ ̄P̄ ̄V̄ ̄Q̄ ̄Ē ̄J̄ ̄Ḡ ̄B̄ ̄W̄ ̄L̄ ̄Ē ̄Ī ̄R̄ ̄Ḡ ̄J̄ ̄Ū ̄V̄ ̄L̄

̄B̄ ̄W̄ ̄L̄ ̄L̄ ̄Q̄ ̄J̄ . ̄L̄ ̄V̄ ̄Ē ̄Ȳ ̄R̄ ̄Q̄ ̄W̄ ̄J̄ ̄B̄ ̄W̄ ̄L̄

̄Ē ̄V̄ ̄P̄ ̄J̄ ̄W̄ ̄B̄ ̄W̄ ̄Ȳ ̄Ḡ 4 5 : 3 2



JESUS
IS
COMING



May 5–11

Doctrine and Covenants 45

“The Promises ... Shall Be Fulfilled”

Wacky Word Trails

Instructions: Start with the circled letter, use the clues to find and mark the trail of letters of all the connected bolded words from the scripture through the maze to the last letter. The path can wander up, down, left, and right at any point, even in the middle of the word.

Doctrine and Covenants 45:44–45

And then they shall **look** for me, and, **behold**, I will **come**; and they shall **see me** in the **clouds** of **heaven**, **clothed** with **power** and **great glory**; with all the **holy angels**; and he that **watches not** for me shall be **cut off**. But before the **arm** of the **Lord** shall **fall**, an angel shall sound his **trump**, and the **saints** that have **slept** shall **come forth** to **meet** me in the cloud.

C G M W S H O L C F F O M R A
Z Q C K S D U X G E L S F T H
H E B O C G P H N **A** D L O R F
O L E M Z D B S M E B E A N W
X D T N T S L C O M E H V E A
N H A I K O O R E E M T V C T
D O S D P O W E T T B U E H P
D L Y R N T H Y U R T C S V R
G R L O V F Z T M P E X M G E
F B K L E X E B I S S J X E X
A Y X D Y R O H T E L E Z I H
V T H S E R W A P E S P T G L
Z W O S A G B P C L L A O N O
K T R M T D Y W L T R F T Y R
I Y V H U E H T O O O P X H L

Fill in the Blank

Doctrine and Covenants 45:9

And even so I have _____ mine _____ into the _____,
to be a _____ to the world, and to be a _____ for my _____, and for the
_____ to _____ to it, and to be a _____ before my _____ to
_____ the _____ before me.

covenant
world
way

people
everlasting

light
messenger

standard
face

Gentiles
seek

sent
prepare

Mystery Picture Graph

Instructions: Find the mystery picture below by plotting and connecting the points of each line on the coordinate graph. Connect all the points in Line 1, stop, pick up your pencil, and then connect all the points in Line 2, and so on for the rest of the lines. The dot for the first (X,Y) coordinate pair on Line 1 has been placed for you.

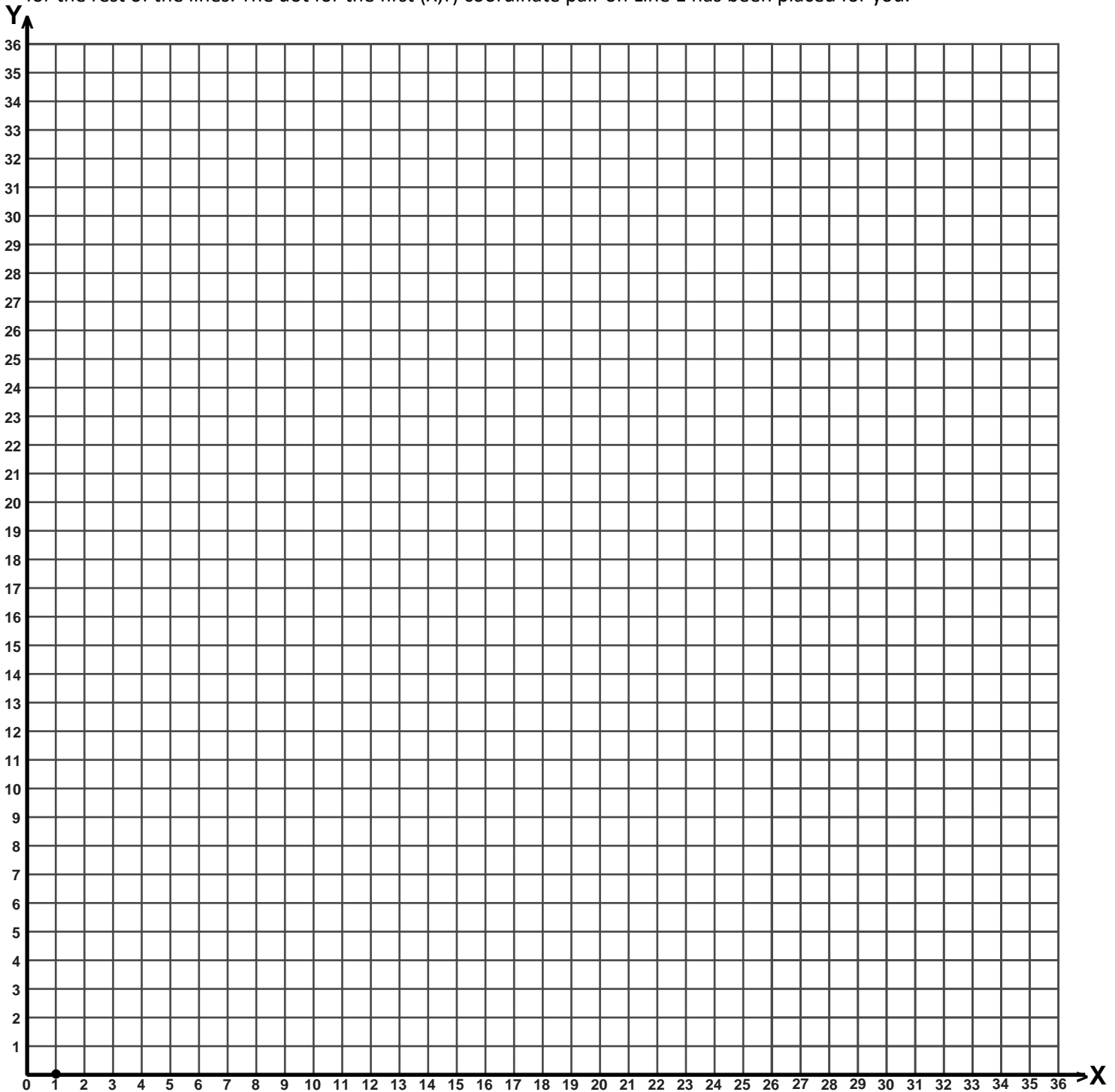

Line 1	(1, 0)	(5, 1)	(9, 0)	(9, 2)	(1, 2)	(0, 0)	Line 2	(5, 1)	(5, 7)	Line 3	(0, 8)	(5, 7)
(10, 8)	(8, 15)	(15, 15)	(15, 18)	(14, 18)	(13, 17)	(9, 17)	(9, 19)	(8, 19)	(8, 20)	(10, 22)	(10, 24)	(7, 27)
(3, 27)	(0, 24)	(0, 22)	(2, 20)	(2, 19)	(0, 13)	(0, 11)	(1, 11)	(0, 8)	(1, 8)	(3, 4)	(1, 2)	Line 4
(9, 2)	(7, 4)	(9, 8)	Line 5	(1, 11)	(3, 17)	Line 6	(3, 21)	(4, 20)	(6, 20)	(7, 21)	Line 7	(6, 23)
(6, 22)	Line 8	(4, 23)	(4, 22)	Line 9	(0, 24)	(10, 24)	Line 10	(1, 24)	(1, 21)	Line 11	(9, 24)	(9, 21)
Line 12	(14, 0)	(15, 0)	(15, 15)	(14, 15)	(14, 0)	Line 13	(15, 18)	(15, 32)	(14, 32)	(14, 18)	Line 14	(15, 18)
(32, 18)	(29, 21)	(35, 25)	(31, 27)	(33, 30)	(15, 30)							

May 5–11

Doctrine and Covenants 45

“The Promises ... Shall Be Fulfilled”

Instructions: Fill in the blank puzzle grid using the word bank with the bold words from the scripture below. Place the words in the correct place on the grid.

Doctrine and Covenants 45:3–5

Listen to him who is the **advocate** with the **Father**, who is **pleading** your **cause before** him— Saying: Father, behold the **sufferings** and **death** of him who did no sin, in whom thou wast well **pleased**; behold the **blood** of thy **Son** which was **shed**, the blood of him whom thou **gavest** that thyself might be **glorified**; Wherefore, Father, **spare** these my **brethren** that **believe** on my **name**, that they may **come** unto me and have **everlasting life**.

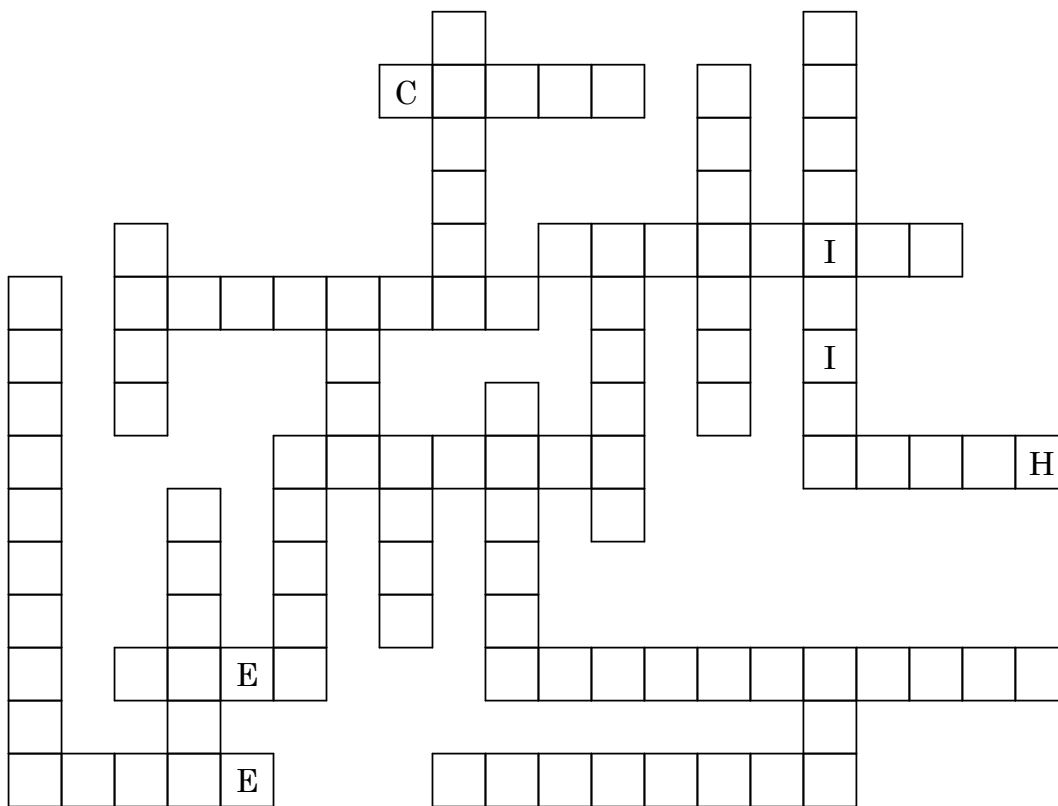

3 Letters	5 Letters	Listen	8 Letters	10 Letters
Son	blood	Father	pleading	sufferings
	death	gavest	advocate	
4 Letters	spare		brethren	11 Letters
life	cause	7 Letters		everlasting
shed		believe	9 Letters	
come	6 Letters	pleased	glorified	
name	before			

May 5–11

Doctrine and Covenants 45

“The Promises ... Shall Be Fulfilled”

The gospel of Jesus Christ is a **standard** to the world.

Come, Follow Me 2025 Manual

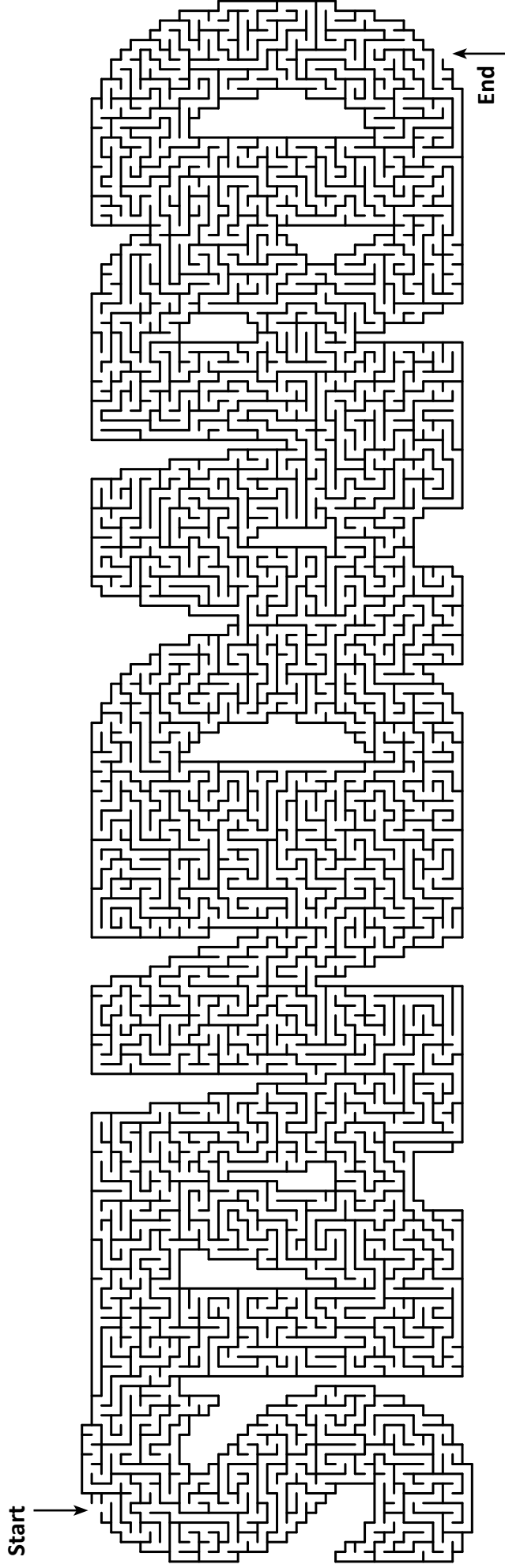

May 5–11

Doctrine and Covenants 45

“The Promises ... Shall Be Fulfilled”

Letter Sudoku

Instructions: Solve the letter sudoku puzzle the same way you’d solve a numeric sudoku. Check your puzzle against the answer key on ColorMeChristian.org. Every column, row, and group of nine must contain every letter in the word(s) **LAWGIVER**.

Doctrine and Covenants 45:58-59

And the earth shall be given unto them for an inheritance; and they shall multiply and wax strong, and their children shall grow up without sin unto salvation. For the Lord shall be in their midst, and his glory shall be upon them, and he will be their king and their **lawgiver**.

	A		W			E	V
					R		
			E				
W	V		R			I	E
E		R	V		W		
			I				L
	R	V			G		
		W			V	A	



Hidden Picture: You can help others feel welcome at church. Can you find 4 copies of the smiling, waving children who are welcoming people to church? It will be tricky; the pictures may be smaller, on their side, or even upside down! Then, see if you can find one copy of the animals as well.

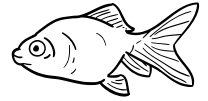

May 12–18

Doctrine and Covenants 46–48

“Seek Ye Earnestly the Best Gifts”

Reverse Word Search

Instructions: Instead of looking for words in a grid, place the bold words in the scripture in the empty word search puzzle. The words may be forwards, backwards, up, down, or diagonally. The start letter of the words have been placed in the grid to get you started.

Doctrine and Covenants 46:13–14, 17, 26

To **some** it is **given** by the **Holy Ghost** to know that **Jesus Christ** is the **Son of God**, and that he was **crucified** for the **sins of the world**. To **others** it is given to **believe** on their **words**, that they also might have **eternal life** if they **continue faithful**. And again, verily I say unto you, to some is given, by the **Spirit of God**, the word of **wisdom**. And all these **gifts** come from God, for the **benefit** of the **children** of God.

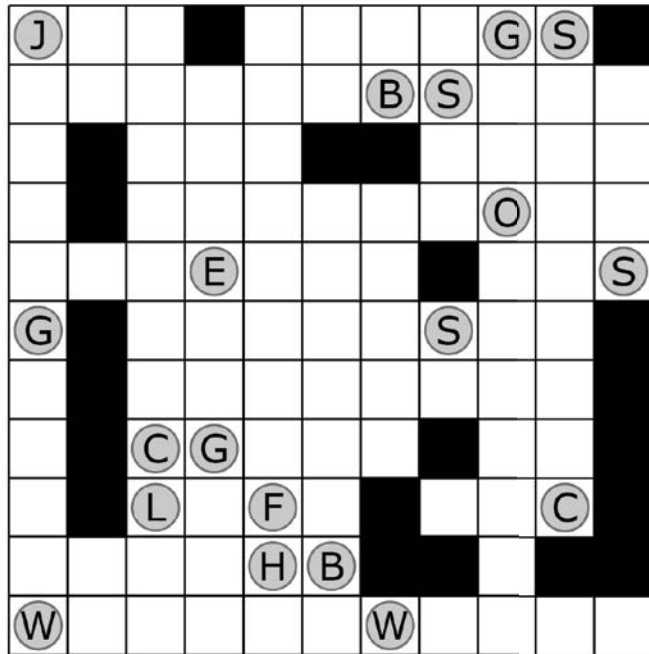

May 12–18

Doctrine and Covenants 46–48

“Seek Ye Earnestly the Best Gifts”

Letterbox Puzzle

Instructions: Find the hidden word in the puzzle below by crossing out all letters that occur twice or more. Capitalized and lowercase letters count as unique letters for this puzzle. The letters left over will form a word. Write down the left over letters like you would read a book, from left to right and top to bottom. Then find the hidden word in the scripture or phrase below and circle it.

Come, Follow Me Manual 2025

Heavenly Father gives me spiritual gifts to bless others.

Write the hidden word:

d	v	H	S	m	v
m	p	b	Q	e	i
R	g	Q	F	I	N
T	d	g	F	H	u
k	A	y	s	N	e
k	y	m	b	L	s

Translation Station

Instructions: Translate the sign language letters below into English to discover the hidden message. Write the alphabet letter beneath each hand sign. Use the key at the back of the book to help you.

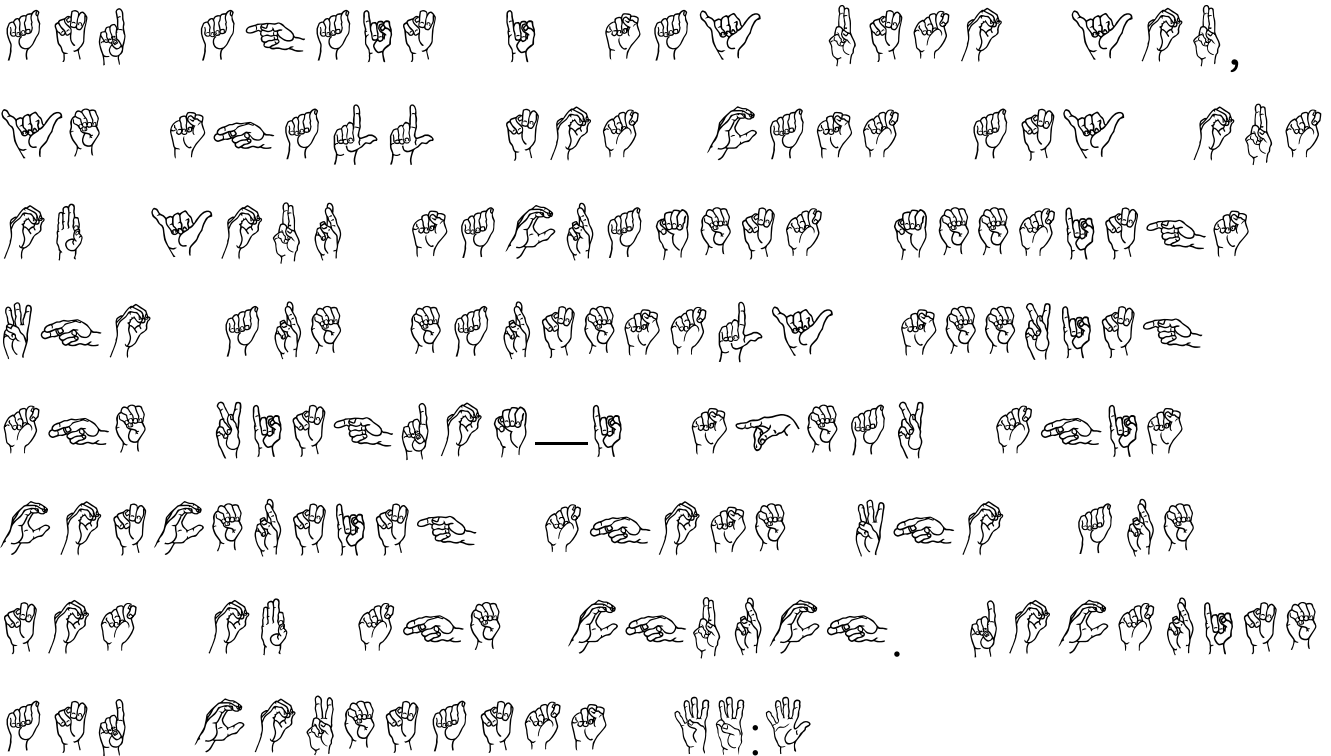

May 12–18

Doctrine and Covenants 46–48

“Seek Ye Earnestly the Best Gifts”



Handwriting Practice

Practice your handwriting by tracing the sentence below. Then use the blank lines to write the sentence on your own.

I can record my history.

I can record my history.

Blank handwriting practice lines consisting of a solid top line, a dashed middle line, and a solid bottom line.

May 19–25

Doctrine and Covenants 49–50

“That Which Is of God Is Light”

Word Search

Instructions: Find the bold words from the scripture in the word search puzzle. Each word could be hidden forwards, backwards, up, down, or diagonally.

Doctrine and Covenants 49:12–14

Believe on the **name** of the **Lord** Jesus, who was on the **earth**, and is to **come**, the **beginning** and the **end**; **Repent** and be **baptized** in the name of Jesus **Christ**, according to the **holy commandment**, for the **remission** of **sins**; And whoso **doeth** this shall **receive** the **gift** of the Holy **Ghost**, by the **laying** on of the **hands** of the **elders** of the **church**.

F X T B V U L T C T B N V C I
M Q F E L Q Z W N N B Y M O E
E M Z O M E Z H P E A Y C M V
N L R Y N A W T H M P A L E M
D D D P S X N E C D T E R O M
R B T E V N S O R N I O R P H
E M K H R T I D U A Z Z M E Y
M H T T H S F S H M E Q V T X
I S X R O C T G C M D I R S Q
S D G A N R U F W O E L W I T
S O H E E X D C I C U A P R X
I N O S D N A H E G T Y G H Q
O Q S X R U P R U W R I E C T
N X T Z M E B E G I N N I N G
E V E I L E B C L C V G P W C

Unscrambler

Instructions: Unscramble the words below; look at the bold words in the scripture for a hint.

The Family: A Proclamation to the World, Paragraph 1

We, the First Presidency and the Council of the Twelve Apostles of The Church of Jesus Christ of Latter-day Saints, **solemnly proclaim** that **marriage** between a **man** and a **woman** is **ordained** of **God** and that the **family** is **central** to the **Creator’s plan** for the eternal **destiny** of His children.

dog _____

staroce _____

drendiao _____

amn _____

mnleslyo _____

oiprmcla _____

neitdys _____

giaarme _____

moanw _____

napl _____

enctrla _____

lmyfai _____

Mystery Picture Graph

Instructions: Find the mystery picture below by plotting and connecting the points of each line on the coordinate graph. Connect all the points in Line 1, stop, pick up your pencil, and then connect all the points in Line 2, and so on for the rest of the lines. The dot for the first (X,Y) coordinate pair on Line 1 has been placed for you.

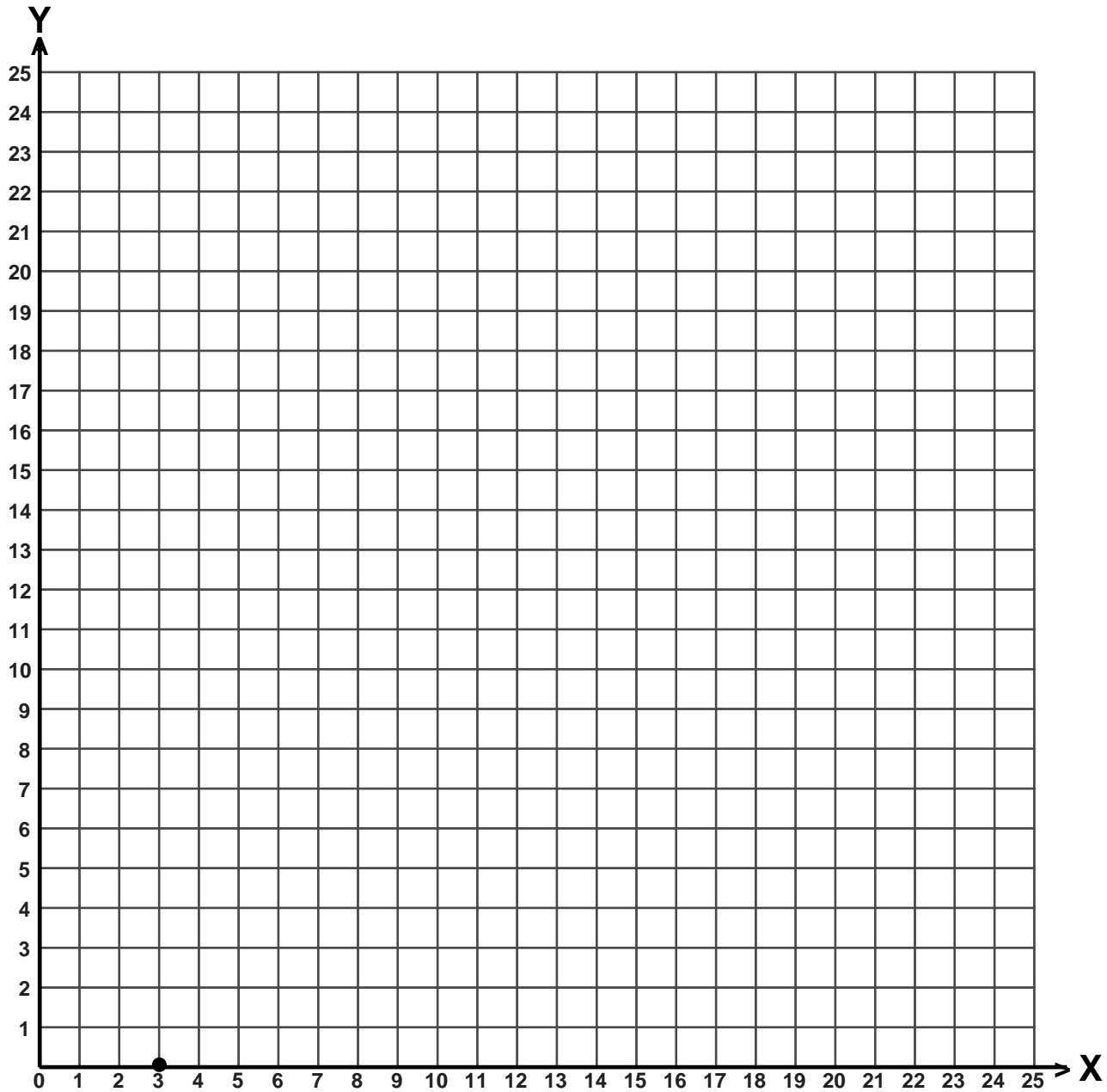

Line 1	(3, 0)	(2, 0)	(2, 13)	(3, 13)	(3, 0)	Line 2	(3, 13)	(2, 13)	(2, 15)	(4, 15)	(4, 13)	(5, 12)
(7, 17)	(8, 17)	(8, 18)	(9, 18)	(9, 19)	(11, 22)	(12, 22)	(14, 20)	(14, 19)	(12, 17)	(11, 18)	(11, 19)	(12, 20)
(13, 20)	Line 3	(9, 17)	(10, 17)	(10, 18)	(11, 18)	Line 4	(9, 17)	(10, 16)	(11, 16)	(12, 17)	(14, 15)	(16, 16)
(16, 13)	(14, 14)	Line 5	(14, 15)	(13, 14)	(10, 13)	(9, 11)	Line 6	(10, 10)	(10, 13)	Line 7	(14, 13)	(16, 12)
(16, 11)	(12, 13)	(11, 13)	(10, 12)	(11, 11)	(13, 11)	(13, 8)	(15, 8)	(15, 11)	Line 8	(16, 10)	(16, 5)	(15, 4)
Line 9	(3, 13)	(4, 11)	Line 10	(3, 11)	(4, 8)	(7, 11)	(8, 14)	Line 11	(7, 11)	(6, 6)	(6, 0)	Line 12
(8, 0)	(12, 6)	Line 13	(11, 0)	(13, 8)	Line 14	(15, 1)	(14, 7)	Line 15	(0, 7)	(2, 7)	Line 16	(3, 7)
(6, 7)	Line 17	(17, 7)	(21, 7)	Line 18	(16, 7)	(17, 7)	Line 19	(11, 16)	(10, 14)	Line 20	(12, 16)	(12, 14)
Line 21	(7, 8)	(8, 7)	(11, 10)	Line 22	(12, 10)	(9, 6)	(8, 6)	(6, 7)	Line 23	(6, 6)	(8, 5)	(9, 5)
Line 24	(3, 15)	(3, 20)	(0, 20)	(0, 17)	(1, 17)	(1, 19)	(2, 19)	(2, 15)	Line 25	(7, 10)	(9, 9)	

May 19–25

Doctrine and Covenants 49–50

“That Which Is of God Is Light”

Fallen Phrase

Instructions: The letters in each column have fallen from the grid. Put them back correctly to rebuild the phrase. Cross out each letter in the jumble below once you place it in the grid. Pay attention because the letters in each column are scrambled. Start with simple 1 or 2 letter words and use the process of elimination. To check your answer, read: **Doctrine and Covenants 50:23–24**

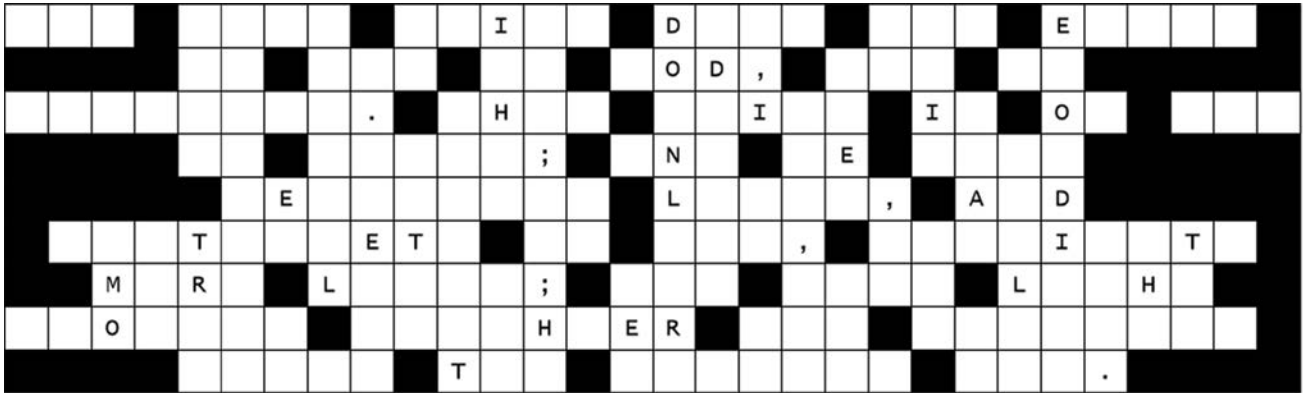

E
 N
 S U H H N
 I R C O G H T T O E H B H E
 E I N T L W H H F H R G H C A T T N T G
 R K I E S I E G H G C N G E O T H A N T S A Y D T H
 D N O N T T T S I T V E E T P W D D T T R O R I I V T G O
 A A D O U S A N B R T O I T A G I A H H N D C A G H I E Y
 G C R W N H H L I I I T A H A N D F C D T E D I S F E F R D



May 19–25

Doctrine and Covenants 49–50

“That Which Is of God Is Light”

Word Sudoku

Instructions: Solve this word sudoku puzzle the same way that you’d solve a numeric sudoku. Each of the bold words in the scripture below is found once in every row, column and 3x3 box.

The Family Proclamation to the World, Paragraph 3

In the premortal realm, spirit sons and daughters knew and worshipped God as their Eternal Father and accepted His plan by which His children could obtain a physical **body** and gain earthly experience to **progress** toward **perfection** and ultimately realize their **divine destiny** as heirs of eternal life. The divine plan of happiness enables family relationships to be perpetuated beyond the grave. Sacred ordinances and covenants available in holy temples make it possible for individuals to **return** to the **presence** of God and for **families** to be **united** eternally.

		united	progress					destiny
		families	body			presence		return
			families			progress	divine	
	united	progress	return			divine		
	families			destiny		body		
				progress	families	united		perfection
				families		return	body	presence
				return	progress	families		divine
families		return			body		progress	

Instructions: Connect all of the letters in the maze and then write the phrase in the blanks below. Don't be tricked by letters that take you into a dead end! There is only one path through the maze.

 ----- : ----- , ----- ;
 ----- ; ----- , -----
 ----- ; ----- , -----
 ----- .

Articles of Faith 1:4

Start

E	B	E	L	I	E	T	H	P	T	P	R	P	N	I	N	P	I	P	L	E	S	A	N	D	O	R	N	A
W	E	B	E	E	V	E	E	F	S	T	S	I	C	R	I	I	C	I	P	L	E	N	A	N	D	O	I	N
E	B	E	L	I	E	V	H	E	R	S	R	S	T	P	R	C	N	C	I	P	L	A	S	A	N	D	D	R
E	V	E	I	E	V	T	T	H	I	R	I	R	S	T	P	R	I	N	C	I	P	L	E	S	A	N	D	O
A	E	V	E	T	H	A	T	T	F	E	F	I	T	P	R	G	N	C	T	F	O	S	S	C	E	A	N	R
H	T	E	V	E	T	H	A	T	T	H	E	P	S	O	G	E	H	T	F	O	S	E	C	N	A	N	I	D
A	H	T	E	T	T	T	T	H	E	F	E	R	E	F	I	R	S	T	F	A	I	T	C	N	C	N	I	
T	A	H	A	H	A	T	T	H	E	F	I	L	A	F	S	R	S	T	I	A	I	E	H	I	W	E	W	E
T	T	T	T	A	T	T	H	E	F	E	R	A	R	I	T	S	C	E	T	I	E	H	I	N	T	S	T	W
H	T	F	E	H	T	H	E	F	I	F	E	R	E	R	F	C	E	S	T	T	H	T	N	G	H	O	S	T
E	H	I	F	E	H	E	F	I	R	I	F	E	T	S	N	O	C	T	S	H	C	H	T	Y	N	I	Y	A
F	E	R	I	F	E	F	I	R	S	R	I	F	F	T	O	C	O	S	I	C	S	U	H	L	G	N	I	L
I	F	S	R	I	R	S	T	F	T	S	R	I	A	O	C	E	S	T	R	H	U	S	E	O	O	R	T	H
R	P	T	S	R	S	T	P	A	F	T	S	T	I	C	E	S	T	S	I	R	I	E	L	H	N	U	R	L
I	R	P	T	S	R	P	R	I	A	F	N	E	N	O	C	E	S	T	S	I	E	J	O	E	O	O	U	A
N	I	R	P	T	I	R	I	N	I	N	E	P	E	R	D	N	O	C	T	S	J	D	R	H	F	F	O	U
C	N	I	R	P	N	I	C	T	N	N	E	P	E	N	O	C	E	S	T	E	G	I	T	H	S	F	O	
I	C	N	I	I	C	I	P	I	N	A	T	N	T	N	D	N	O	C	E	S	H	T	F	F	A	N	O	U
P	L	C	N	P	L	P	L	P	C	N	C	N	A	E	P	E	R	O	C	E	T	R	T	O	N	I	N	S
L	E	I	C	L	M	I	E	L	H	T	E	C	N	N	E	P	D	N	O	C	R	O	F	S	D	S	S	N
E	L	P	L	E	I	Y	B	Y	I	H	T	E	N	E	P	E	R	D	N	O	T	R	O	H	S	F	S	I
S	E	M	M	I	Y	B	M	B	I	I	E	C	N	A	E	P	E	R	D	N	D	T	R	T	F	O	F	S
E	M	M	I	Y	B	M	S	I	T	H	T	E	C	T	N	E	P	E	R	D	R	E	T	I	S	N	S	I
M	M	I	Y	B	M	S	I	T	P	T	E	C	N	A	T	N	E	P	E	R	E	P	E	N	N	O	N	O
M	I	Y	I	Y	S	I	T	P	A	B	D	E	T	H	T	T	N	E	P	E	P	E	N	N	O	I	O	F
I	Y	B	M	S	I	T	P	A	B	D	R	I	H	T	E	A	T	C	E	P	E	N	T	O	I	S	N	O
S	R	E	M	M	S	I	T	P	A	B	D	H	T	E	C	N	A	N	N	E	N	T	A	I	S	S	I	M
I	E	M	M	I	Y	S	I	T	E	M	M	D	R	I	H	C	N	A	T	N	T	O	N	S	S	I	M	E
E	M	M	I	Y	B	M	S	E	M	M	I	R	I	H	T	E	C	N	C	T	A	N	O	I	S	S	I	R
R	E	M	M	I	Y	B	M	M	M	I	Y	B	M	S	R	T	E	T	N	A	N	R	N	O	I	S	R	E
M	O	F	M	M	I	Y	M	M	M	Y	I	M	S	I	I	H	T	E	C	N	M	E	R	S	E	H	T	H
E	F	N	O	I	S	R	E	I	Y	B	M	S	I	T	P	A	R	I	E	C	M	M	E	R	H	T	R	E
R	E	R	O	F	R	E	M	M	I	M	S	I	T	P	A	B	D	H	T	E	I	E	R	O	N	F	O	R
E	H	O	F	N	S	R	E	M	Y	B	M	S	I	T	P	A	R	I	H	T	Y	R	S	I	O	N	F	O
H	T	R	N	O	I	S	R	M	I	E	M	M	I	M	A	B	D	R	I	H	B	M	S	O	N	F	O	R
E	R	O	F	N	O	I	S	R	E	M	M	I	Y	B	M	S	I	T	R	I	B	A	I	N	F	O	R	T
R	E	R	E	H	T	R	I	O	I	S	M	M	I	Y	B	M	T	P	D	R	D	P	T	I	S	M	T	H
E	H	T	H	T	R	O	F	N	S	R	E	M	M	I	Y	B	I	A	B	D	B	A	P	T	M	B	R	E

Finish

May 19–25

Doctrine and Covenants 49–50

“That Which Is of God Is Light”

Instructions: Using the Across and Down clues, write the correct words in the numbered grid below. Hint: all of the words in the crossword come from the scripture below.

Doctrine and Covenants 50:40–46

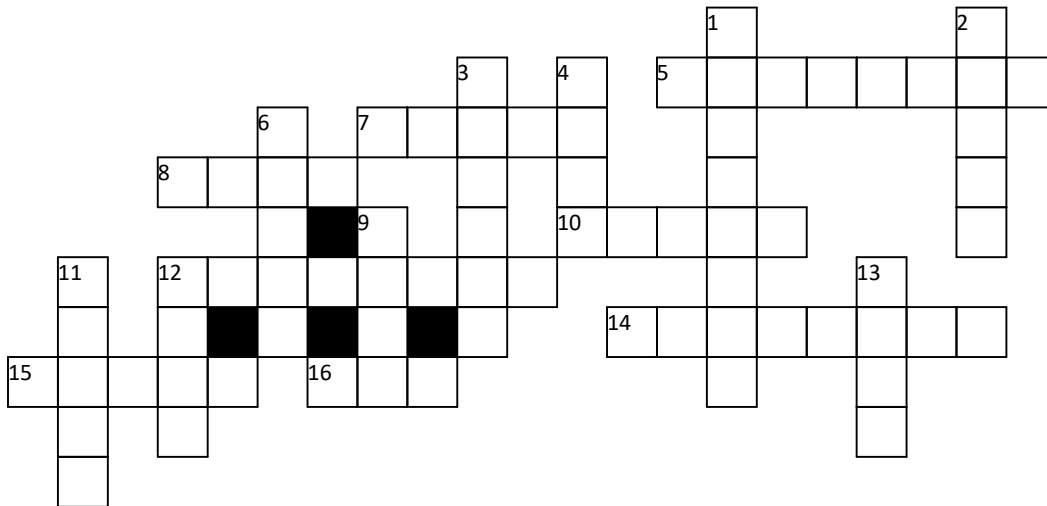

ACROSS

5. someone who keeps sheep together in a flock
7. the enabling power from God that allows men and women to obtain blessings in this life and to gain eternal life and exaltation after they have exercised faith, repented, and given their best effort to keep the commandments
8. to accept or allow oneself to be subjected to especially without giving way
10. completely prepared or in condition for immediate action or use or progress
12. get something; come into possession of
14. win a victory over
15. the sound produced in a person's larynx and uttered through the mouth, as speech or song
16. perceive by sight or have the power to perceive by sight

DOWN

1. a human offspring (son or daughter) of any age
2. knowledge of things as they are, and as they were, and as they are to come
3. biological male parent of Jesus
4. an unpleasant emotion caused by the belief that someone or something is dangerous, likely to cause pain, or a threat
6. to be attentive or vigilant
9. that which belongs to me
11. a lump or mass of hard consolidated mineral matter, rock
12. the solid mineral material forming part of the surface of the earth; stone
13. unable to find one's way; not knowing one's whereabouts

May 26–June 1

Doctrine and Covenants 51–57

“A Faithful, a Just, and a Wise Steward”

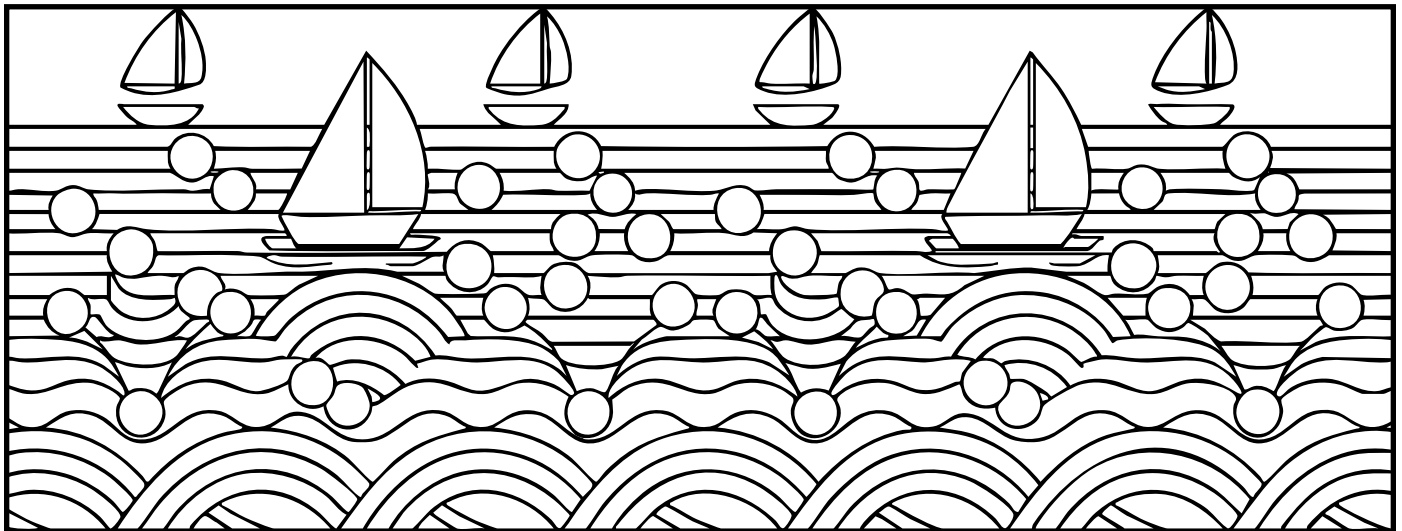

C O V E N A N T

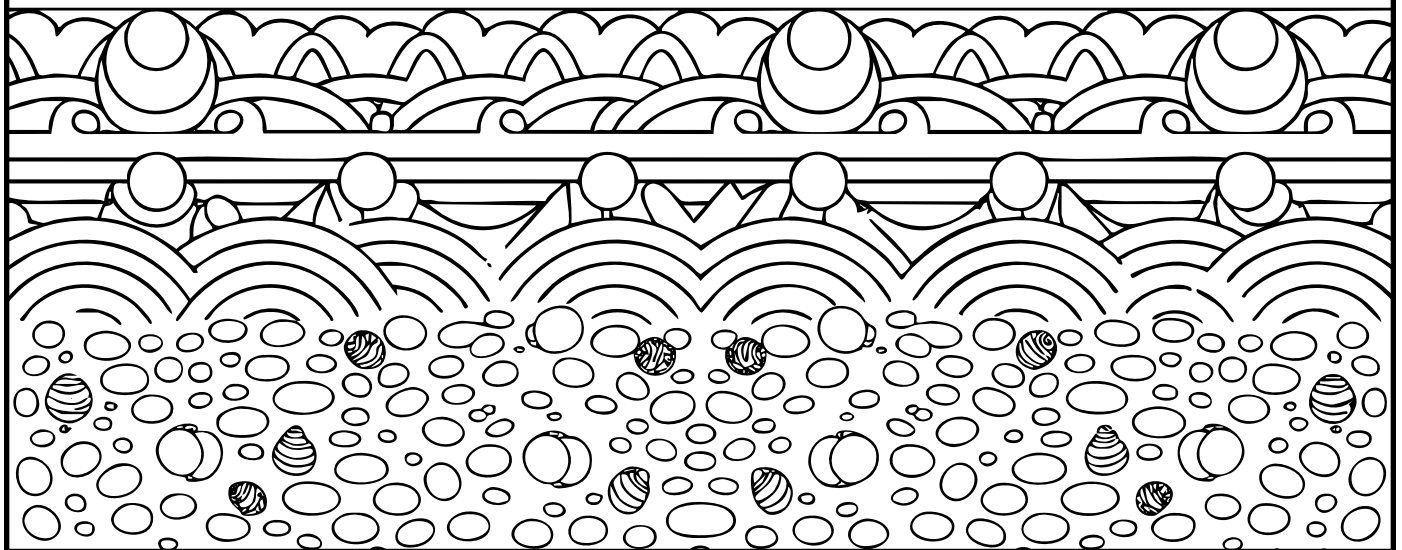

But blessed are they who have kept the covenant and
observed the commandment, for they shall obtain mercy.

Doctrine and Covenants 54:6

May 26–June 1

Doctrine and Covenants 51–57

“A Faithful, a Just, and a Wise Steward”

Missing Vowels Word Search

Instructions: Find the hidden words. The words have been placed horizontally, vertically, diagonally, forwards, or backwards, and the vowels have been removed. When you locate a word, draw an ellipse around it and fill the vowels in.

Doctrine and Covenants 55:2-3

And then thou shalt be **ordained** by the **hand** of my **servant Joseph Smith, Jun.**, to be an **elder** unto this **church**, to **preach repentance** and **remission** of **sins** by way of **baptism** in the **name** of Jesus **Christ**, the Son of the living God. And on whomsoever you shall **lay** your **hands**, if they are **contrite** before me, you shall have **power** to give the **Holy Spirit**.

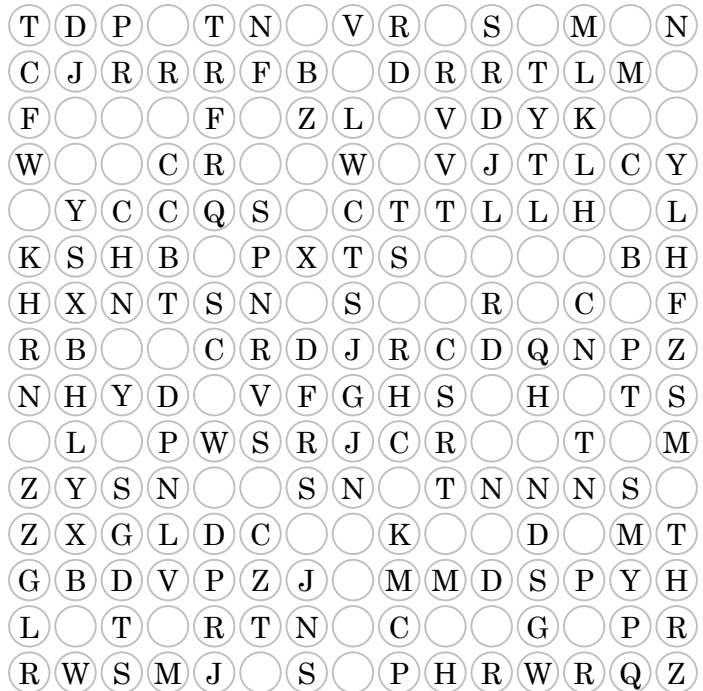

Knight Moves - Find a Word

Instructions: Start with any letter in the puzzle to see if it's the beginning of a word. To get to the second letter, jump two squares in any direction except diagonally, and then one square in a different direction. Your path will look like a capital L. Only one route through the puzzle will make a word. Write the letters of the word you discover in the blanks below as you jump through the squares:

1 2 3 4 5 6 7 8

Now can you find this word in the following scripture?

Doctrine and Covenants 51:9

o	l	e
s		h
y	n	t

May 26–June 1

Doctrine and Covenants 51–57

“A Faithful, a Just, and a Wise Steward”

I can use the blessings God has given me to **bless** others.

Come, Follow Me 2025 Manual

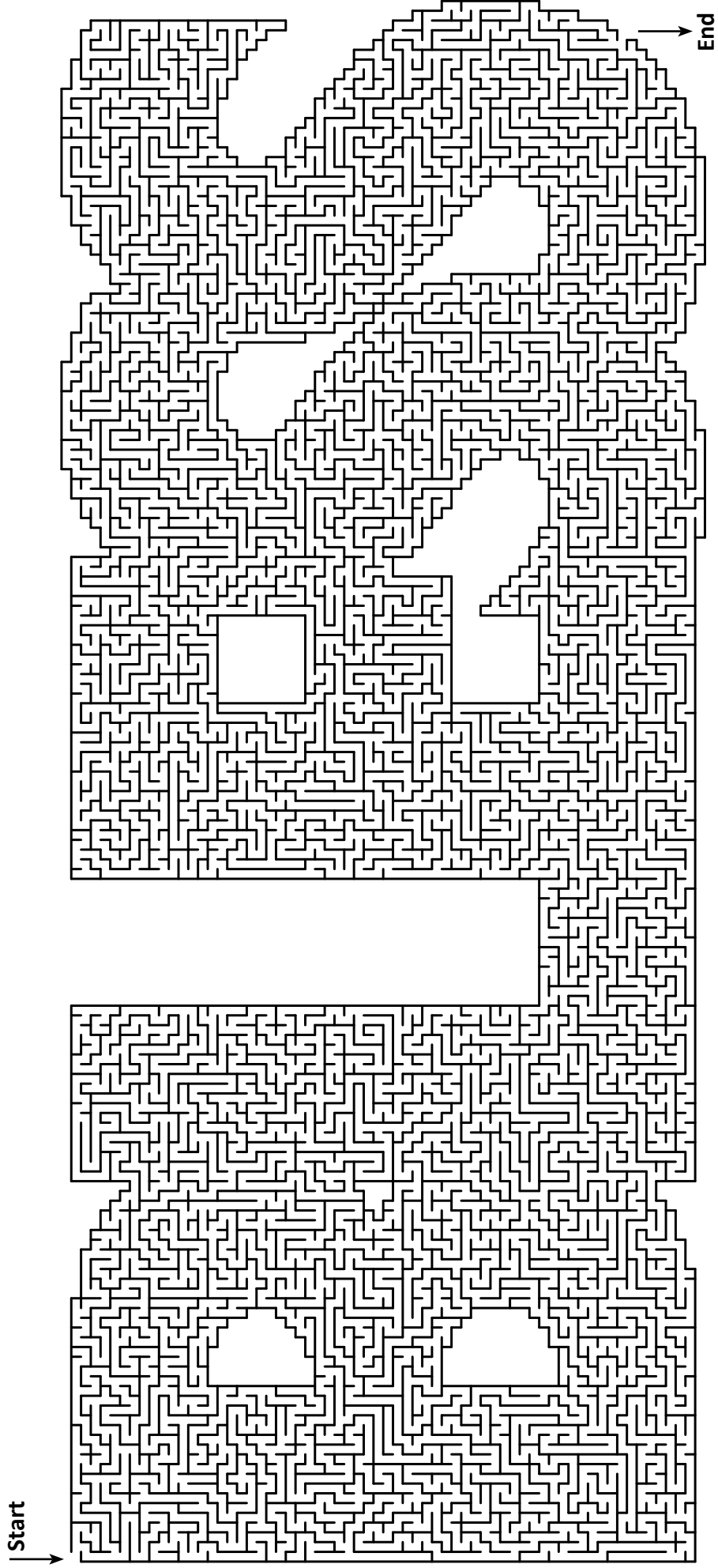

May 26–June 1

Doctrine and Covenants 51–57

“A Faithful, a Just, and a Wise Steward”

Word Square

Instructions: Word squares are a liike Sudoku puzzles, but each letter can occur only once in each row and in each column. Check your puzzle against the answer key on ColorMeChristian.org. Every row and column must contain every letter in the word **LAYING**. This word can be written in the gray row.

Doctrine and Covenants 53:3

Take upon you mine ordination, even that of an elder, to preach faith and repentance and remission of sins, according to my word, and the reception of the Holy Spirit by the **laying** on of hands;

I			G	Y	N
				G	I
A				N	
			N		
	I				
N	L				A

Secret Code

Instructions: The secret message is written in symbols. In the code key you can find what each symbol means. Write the letter above the symbol and you can read the secret message.

a	b	c	d	e	f	g	h	i	j	k	l	m
□	◇	△	▱	⬡	◻	▽	⊗	◀	∇	▶	▷	▴
n	o	p	q	r	s	t	u	v	w	x	y	z
◁	▭	▽	▮	⬢	◻	⋈	⊗	⊞	◀	◁	▴	⊞

□◻ ▽◻ ◻◻◻◻ ◻◻◻ ◻◻◻ ◻◻◻◻◻◻◻

□◻ ◻◻ ◻◻◻◻◻ ◻◻◻◻◻ ◻◻◻◻ ◻◻◻◻◻◻◻

□◻ ◻◻◻◻◻◻◻ ◻◻◻◻◻ ◻◻◻◻ ◻◻ ◻◻◻

◻◻ ◻◻◻ ◻◻◻◻ ◻◻ ◻◻ ◻◻◻◻ ◻◻◻◻◻◻◻◻◻

◻◻◻ ◻◻◻◻◻◻◻◻ ◻◻◻ ◻◻◻◻◻◻◻◻◻

May 26–June 1

Doctrine and Covenants 51–57

“A Faithful, a Just, and a Wise Steward”



Handwriting Practice

Practice your handwriting by tracing the sentence below. Then use the blank lines to write the sentence on your own.

I can be honest.

I can be honest.

Blank handwriting practice lines for independent practice.

June 2–8

Doctrine and Covenants 58–59

“Anxiously Engaged in a Good Cause”

Wacky Word Trails

Instructions: Start with the circled letter, use the clues to find and mark the trail of letters of all the connected bolded words from the scripture through the maze to the last letter. The path can wander up, down, left, and right at any point, even in the middle of the word.

Doctrine and Covenants 59:20–21

And it **pleaseth** God that he hath **given** all these **things** unto man; for unto this **end** were they **made** to be **used**, with **judgment**, not to **excess**, neither by **extortion**. And in **nothing** doth man **offend** God, or against none is his **wrath kindled**, save those who **confess not** his **hand** in all **things**, and **obey** not his **commandments**.

H	T	W	D	S	P	D	E	L	D	D	A	E	B	X
T	A	R	E	L	Z	T	H	G	N	E	M	V	X	U
H	F	I	S	U	D	N	I	R	I	K	S	S	T	D
I	N	G	W	R	N	G	P	E	J	D	Z	E	M	T
K	W	S	N	O	E	S	E	T	C	O	N	F	P	P
F	D	S	P	T	D	G	Z	X	Y	I	F	V	H	T
W	E	W	H	J	U	M	V	E	E	B	L	S	Y	R
U	Q	F	P	P	R	E	H	N	G	O	M	O	U	M
G	I	N	E	G	T	N	H	I	I	T	P	C	Q	C
U	F	N	V	I	L	T	T	N	O	R	D	O	F	F
X	Q	G	V	Q	L	P	O	N	T	O	N	A	H	E
S	S	B	Q	X	K	M	N	T	X	C	E	S	S	N
N	Z	J	F	B	T	H	E	S	E	X	E	M	G	D
P	W	H	F	E	C	D	M	M	O	C	H	S	A	P
R	M	K	G	B	S	N	A	M	O	I	T	E	E	L

Fill in the Blank

Doctrine and Covenants 59:10–11

For _____ this is a day _____ unto you to _____ from your
 _____, and to _____ thy _____ unto the Most _____;
 Nevertheless thy _____ shall be _____ up in _____ on all
 _____ and at all _____;

labors	rest	times	offered	righteousness	verily
pay	High	appointed	days	vows	devotions

June 2–8

Doctrine and Covenants 58–59

“Anxiously Engaged in a Good Cause”

Translation Station

Instructions: Translate the Morse code below into English to discover the hidden message. Write the alphabet letter beneath each Morse Code letter. Each letter, number, and punctuation is separated by a slash: /. Use the key at the back of the book to help you.

---/./.-/-----/ .-/.-.../...-/ -/..././.-/---/.../
---/.../.../---/.../ ---/---/---/./ ---/.../ -/..././
./.-/.-/./.../-----/ ./-./ -/..././ ..././.-/.../---/.../
-/..././.-/./---/.../---/---/ .-/.-..././ --/.-/..././
.../---/.../ -/..././ ..././-././.../.../ -/---/.../
-/..././ .../..././ ---/.../ --/.-/.../---/---/---/---/
.../---/.../ -/---/ .-.../..././-./..././ -/..././
./---/./ -/---/.../ -/---/ ---/.../.../.../.../.../.../
-/..././ ..././.-/.-/.../---/ .../---/---/---/.../.../.../.../
-/-/.../ ---/---/.../.../.../.../.../.../.../
.../---/.../---/.../.../

SABBATH
DAY

And that thou mayest more fully keep thyself unspotted from the world, thou shalt go to the house of prayer and offer up thy sacraments upon my holy day; (Doctrine and Covenants 59:9)

June 2–8

Doctrine and Covenants 58–59

“Anxiously Engaged in a Good Cause”

Instructions: Fit the bold words from the scripture below into the encircled squares. Words will read forward, backward, up, down, and diagonally and will normally cross other words. Start with the hints provided.

Doctrine and Covenants 58:27–28

Verily I say, men should be **anxiously engaged** in a **good cause**, and do **many things** of their **own free will**, and **bring** to **pass much righteousness**; For the **power** is in **them**, wherein they are **agents** unto **themselves**. And inasmuch as men do good they shall in **nowise lose** their **reward**.

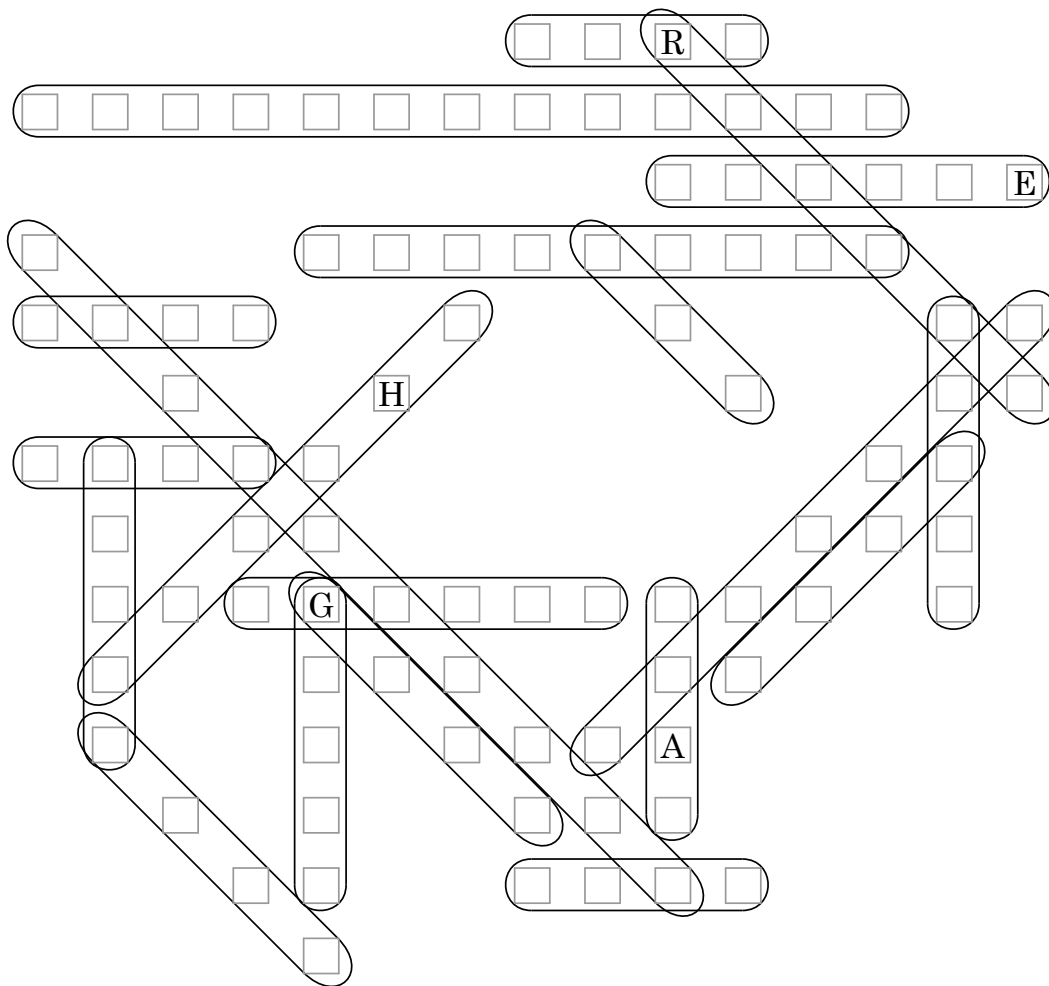

anxiously
things
pass
agents

engaged
own
much
themselves

good
free
righteousness
nowise

cause
will
power
lose

many
bring
them
reward

Sabbath-Day Activities

Arie Van De Graaff

There are lots of things you can do on Sunday. Find five similar things in these four pictures.

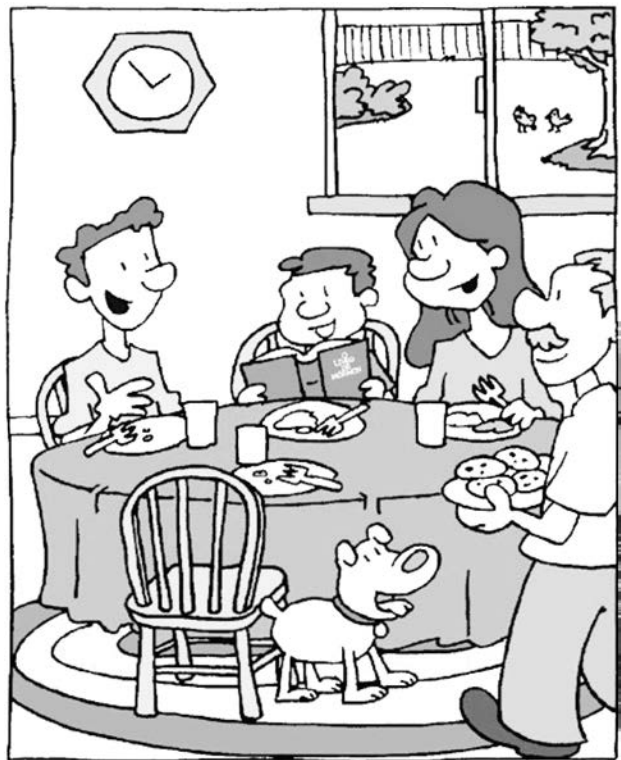

Thanking the Lord

These children are practicing thanking the Lord in all things. Can you lead them through the maze to help them find more things they can be thankful for?

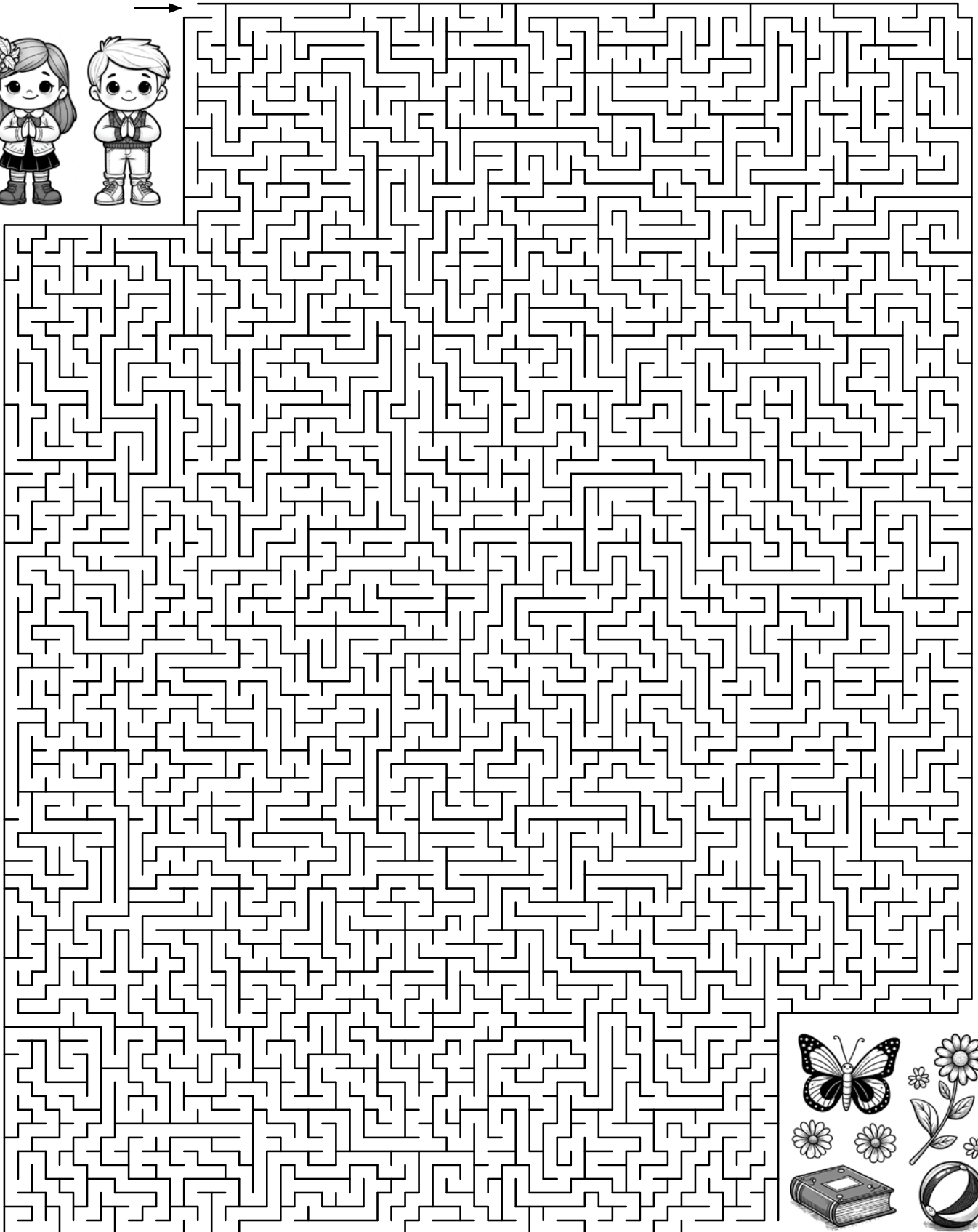

June 2–8

Doctrine and Covenants 58–59

“Anxiously Engaged in a Good Cause”

Letter Sudoku

Instructions: Solve the letter sudoku puzzle the same way you’d solve a numeric sudoku. Check your puzzle against the answer key on ColorMeChristian.org. Every column, row, and group of nine must contain every letter in the word(s) **OBLATIONS**.

Doctrine and Covenants 59:12

But remember that on this, the Lord’s day, thou shalt offer thine **oblations** and thy sacraments unto the Most High, confessing thy sins unto thy brethren, and before the Lord.

				O		L	I
		S			L	T	
O		A					
				I		T	O
			S	L	A		O
					N	B	
		B			I		
			L		S		O
T				N			I

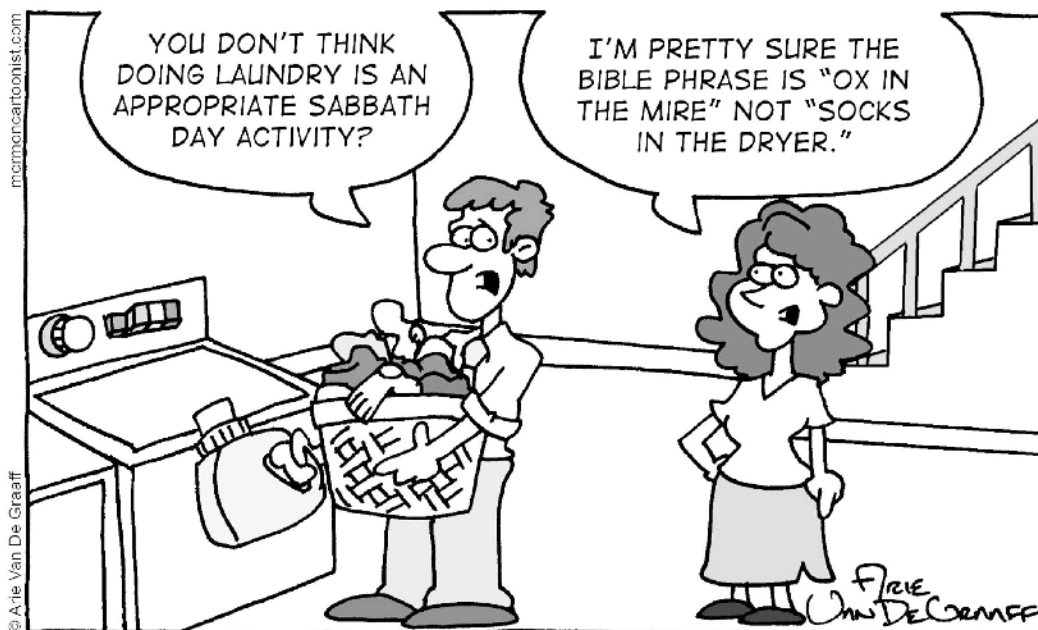

June 9–15

Doctrine and Covenants 60–63

“I Am with the Faithful Always”

Word Angles

Instructions: Find the bold words from the scripture. Each word path may run north, east, south, or west, may make one right-angled turn, and may cross another word path. A few words may make no right angle turn at all.

Doctrine and Covenants 62:1

Behold, and hearken, O ye elders of my church, saith the Lord your God, even Jesus Christ, your advocate, who knoweth the weakness of man and how to succor them who are tempted.

H	Q	G	L	F	B	K	D	X	N	O	C	Y	E	J	F
Z	K	A	D	K	T	K	D	Z	G	T	M	E	H	T	V
L	C	C	U	S	B	G	A	K	N	E	S	S	L	O	Q
R	O	N	Z	Z	E	X	E	D	Y	L	M	S	M	P	Q
G	R	M	W	R	D	R	W	O	V	D	V	B	A	N	A
O	F	C	L	O	Y	H	O	S	W	E	R	S	H	D	O
H	N	W	G	L	A	G	C	Z	L	G	R	O	I	A	G
Y	T	N	K	Q	M	I	S	T	C	O	V	D	A	H	Q
C	H	D	W	N	F	R	Q	P	A	F	Q	L	M	T	C
Y	Y	E	A	L	H	H	N	P	T	S	C	O	H	E	O
O	D	T	Y	A	C	C	P	Y	E	J	K	N	O	W	W
N	B	P	Q	K	R	U	H	C	P	J	M	A	M	K	G
Q	G	M	E	T	J	E	S	U	S	C	G	B	H	E	B
I	Y	I	Z	A	R	K	E	N	U	X	K	C	O	U	T
I	K	G	P	E	Z	G	G	O	Y	A	H	N	L	K	C
B	O	G	R	H	I	R	H	M	X	X	S	R	D	Q	J

Word Star

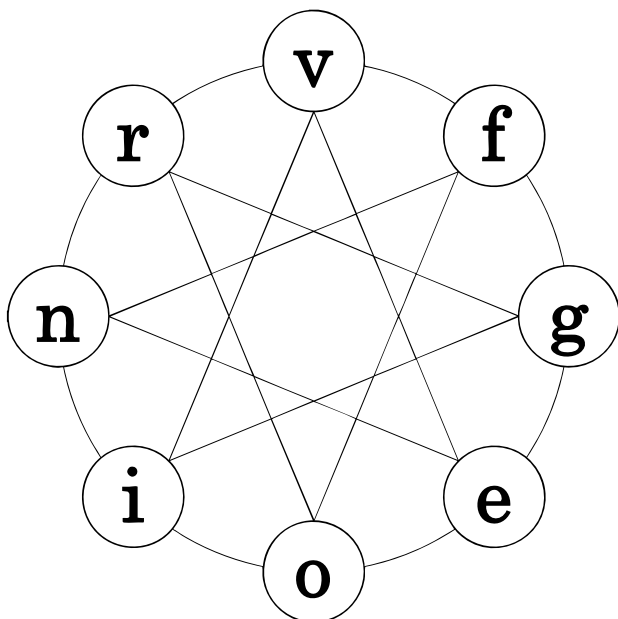

Instructions: Only one route through the word star will make a word. Try each letter and follow the pathway through the star to see if it makes a word.. IF you need a hint, look at the words in the scripture below. Write the letters of the word you discover in the blanks below as you travel through the star:

Now can you find this word in the following scripture?





Doctrine and Covenants 61:2

Mission Call

By Arie Van De Graaff

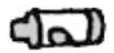
This young woman just received her mission call. Can you find the hidden objects in the picture?



- | | | | | | | | |
|---|---|---|---|---|--|---|---|
|  |  |  |  |  |  |  |  |
| BANANA | BASEBALL BAT | BUTTERFLY | CANDLE | CARROT | CRAYON | HORSESHOE | LADYBUG |
|  |  |  |  |  |  |  |  |
| LEAF | LOLLIPOP | PAINTBRUSH | PEAR | PENCIL | RULER | SCREWDRIVER | TOOTHBRUSH |

June 9–15

Doctrine and Covenants 60–63

“I Am with the Faithful Always”

Cryptogram

Instructions: Each letter on the top stands for a letter in the alphabet. Solve the encrypted phrase by matching each letter on top to a letter in the alphabet on the bottom. Use the key to help you remember what the letters stand for so you can crack the code.

U	C	H	N	W	B	E	Y	M	O	Z	X	L	R	K	P	V	I	G	F	S	J	D	T	Q	A
A	B	C	D	E	F	G	H	I	J	K	L	M	N	O	P	Q	R	S	T	U	V	W	X	Y	Z

Z̄ D̄ W̄ D̄ J̄ Ē , Q̄ Ḡ N̄ R̄ M̄ H̄ R̄ Ū Z̄ H̄ Ā D̄ X̄ J̄

H̄ J̄ Ā , Z̄ D̄ W̄ Ē C̄ Z̄ X̄ R̄ Ū Z̄ H̄ Ā D̄ X̄ J̄ J̄ D̄ Ḡ

R̄ Ū Z̄ H̄ Ā D̄ X̄ J̄ Z̄ M̄ M̄ , F̄ Ḡ J̄ T̄ S̄ J̄ J̄ W̄

B̄ C̄ Ḡ Ḡ N̄ , M̄ R̄ X̄ X̄ M̄ Ḡ B̄ C̄ R̄ M̄ W̄ N̄ Ḡ D̄ ; T̄ J̄ N̄

R̄ Z̄ Ī R̄ D̄ H̄ J̄ Ā N̄ Ī R̄ W̄ Ū X̄ , Z̄ D̄ W̄ R̄

C̄ Z̄ Q̄ Ḡ D̄ J̄ X̄ T̄ J̄ N̄ Ū Z̄ Ō Ḡ D̄ H̄ J̄ Ā ;

W̄ J̄ B̄ X̄ N̄ R̄ D̄ Ḡ Z̄ D̄ W̄ B̄ J̄ Q̄ Ḡ D̄ Z̄ D̄ X̄ Ū 6 1 : 3 6

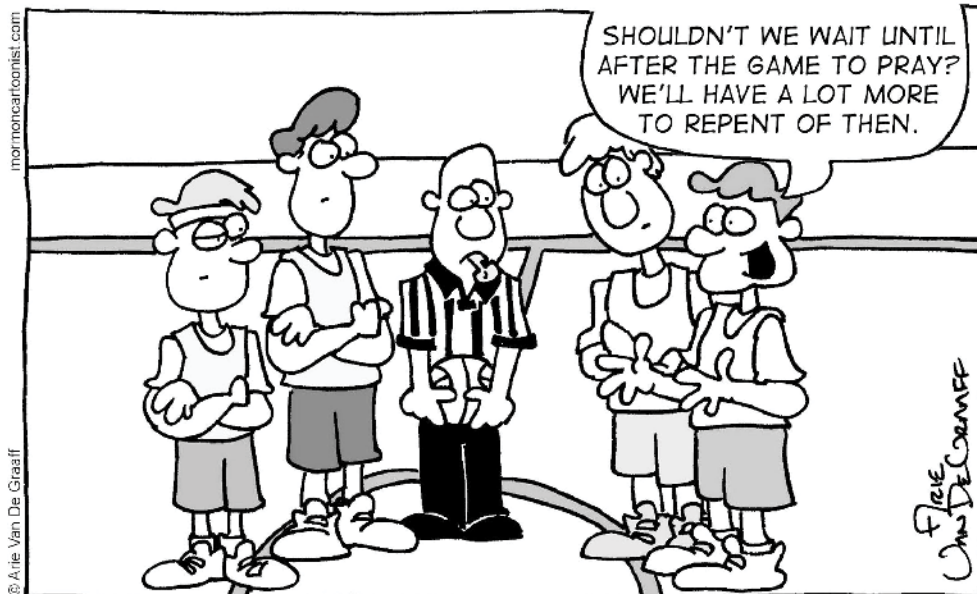

June 9–15

Doctrine and Covenants 60–63

“I Am with the Faithful Always”

Handwriting Practice

Practice your handwriting by tracing the sentence below. Then use the blank lines to write the sentence on your own.

The Lord will forgive me if I repent.

Letterbox Puzzle

Instructions: Find the hidden word in the puzzle below by crossing out all letters that occur twice or more. Capitalized and lowercase letters count as unique letters for this puzzle. The letters left over will form a word. Write down the left over letters like you would read a book, from left to right and top to bottom. Then find the hidden word in the scripture or phrase below and circle it.

Doctrine and Covenants 63:64

Remember that that which cometh from above is sacred, and must be spoken with care, and by constraint of the Spirit; and in this there is no condemnation, and ye receive the Spirit through prayer; wherefore, without this there remaineth condemnation.

Write the hidden word:

G	C	Q	Q	O	P
N	F	W	S	I	G
W	t	c	R	r	p
l	e	a	c	u	i
n	B	B	F	g	r
p	e	u	P	g	T

June 9–15

Doctrine and Covenants 60–63

“I Am with the Faithful Always”

Instructions: Connect all of the letters in the maze and then write the phrase in the blanks below. Don't be tricked by letters that take you into a dead end! There is only one path through the maze.

-----', -----', -----', -----
-----;
-----', -----
-----.

Doctrine and Covenants 60:4

Finish

Start

K	E	T	H	D	F	O	R	I	T	H	E	L	O	R	D	L	E	I	N	T	H	E	A	S	A
A	K	H	T	O	D	F	O	R	I	T	H	E	L	O	R	U	L	E	I	H	E	A	S	L	L
E	E	T	O	G	O	D	F	O	R	I	T	H	E	L	O	R	S	I	S	T	H	S	L	E	L
P	E	H	E	F	G	O	D	F	O	R	I	T	H	E	L	D	R	T	I	S	T	L	E	W	E
S	P	E	F	O	F	G	O	D	F	I	T	H	E	L	O	R	T	I	T	I	L	E	W	E	J
E	B	P	E	R	O	O	D	F	O	R	I	T	O	W	W	H	A	T	I	L	E	W	E	W	Y
B	T	O	W	E	R	O	F	G	O	D	R	I	N	O	W	W	H	A	T	I	W	E	J	E	M
T	A	W	B	R	O	F	G	O	D	F	O	R	K	N	O	W	W	H	A	W	E	J	Y	J	P
A	H	A	T	B	E	S	P	E	A	K	L	K	L	O	N	O	W	W	H	E	J	Y	M	Y	U
H	T	T	B	E	S	P	E	A	K	A	L	L	L	N	K	N	O	W	W	J	Y	M	P	M	E
T	S	T	E	E	P	E	A	L	L	H	A	L	L	L	K	N	O	W	Y	J	P	U	E	K	
S	I	S	K	A	K	E	L	A	L	S	H	A	H	A	L	L	K	J	E	M	P	U	E	K	A
I	T	I	S	K	L	L	A	H	S	N	S	N	S	H	A	L	J	Y	M	P	U	E	K	A	M
T	I	T	W	L	L	A	H	S	N	E	N	E	N	S	H	A	Y	M	P	U	E	K	A	M	L
A	T	I	W	L	A	H	S	N	E	M	L	M	E	N	S	H	M	P	U	E	K	A	M	L	L
H	A	T	O	L	K	A	H	S	M	L	L	L	M	L	Y	A	P	U	E	K	A	M	A	L	A
W	W	O	N	K	E	L	O	H	E	S	A	L	W	E	M	Y	U	E	K	A	M	L	M	A	H
F	O	R	I	T	H	E	R	A	S	L	S	W	E	J	P	U	P	K	A	M	L	L	L	H	S
O	R	I	T	H	E	L	O	R	L	E	W	E	J	Y	M	E	K	A	M	L	L	A	H	S	I
R	L	E	H	E	R	O	R	H	E	W	E	J	Y	M	P	U	E	U	A	M	L	L	H	I	N
I	T	L	E	R	D	R	D	E	H	E	H	E	A	V	E	A	U	P	E	D	A	Y	W	N	E
T	H	H	T	U	R	D	E	H	T	A	E	V	O	E	N	S	A	T	H	E	D	A	Y	I	H
H	H	T	N	I	E	R	N	I	N	N	V	O	B	A	S	A	T	N	T	H	E	D	A	Y	W
E	E	H	I	E	L	U	L	E	I	D	A	M	O	B	O	I	D	I	N	E	Y	A	Y	W	H
E	H	T	N	I	E	I	E	I	N	A	M	O	N	G	V	D	N	D	I	D	W	H	W	H	E
H	E	H	T	N	I	N	I	H	T	T	G	N	H	T	T	H	A	N	D	I	N	I	N	E	N
E	H	E	H	T	N	T	N	E	H	T	G	T	O	F	T	H	A	N	N	T	S	H	N	I	
A	E	H	E	H	T	H	T	R	A	E	H	T	E	S	O	R	A	N	D	T	H	H	A	I	S
V	A	E	E	E	H	T	F	O	S	E	E	H	I	O	E	A	R	T	E	H	A	A	L	S	H
R	A	E	E	H	T	F	O	S	E	I	M	E	M	F	E	E	A	H	D	E	D	W	H	E	A
T	R	A	E	E	H	T	F	E	I	M	R	A	R	T	H	E	E	A	R	Y	A	Y	W	N	L

June 9–15

Doctrine and Covenants 60–63

“I Am with the Faithful Always”

Instructions: Fill in the blank puzzle grid using the word bank with the bold words from the scripture below. Place the words in the correct place on the grid.

Doctrine and Covenants 61:1–2

Behold, and **hearken** unto the **voice** of him who has all **power**, who is from **everlasting** to everlasting, even **Alpha** and **Omega**, the **beginning** and the **end**. Behold, verily thus saith the Lord unto you, O ye **elders** of my **church**, who are **assembled** upon this spot, whose **sins** are now **forgiven** you, for I, the Lord, forgive sins, and am **merciful** unto those who **confess** their sins with **humble hearts**;

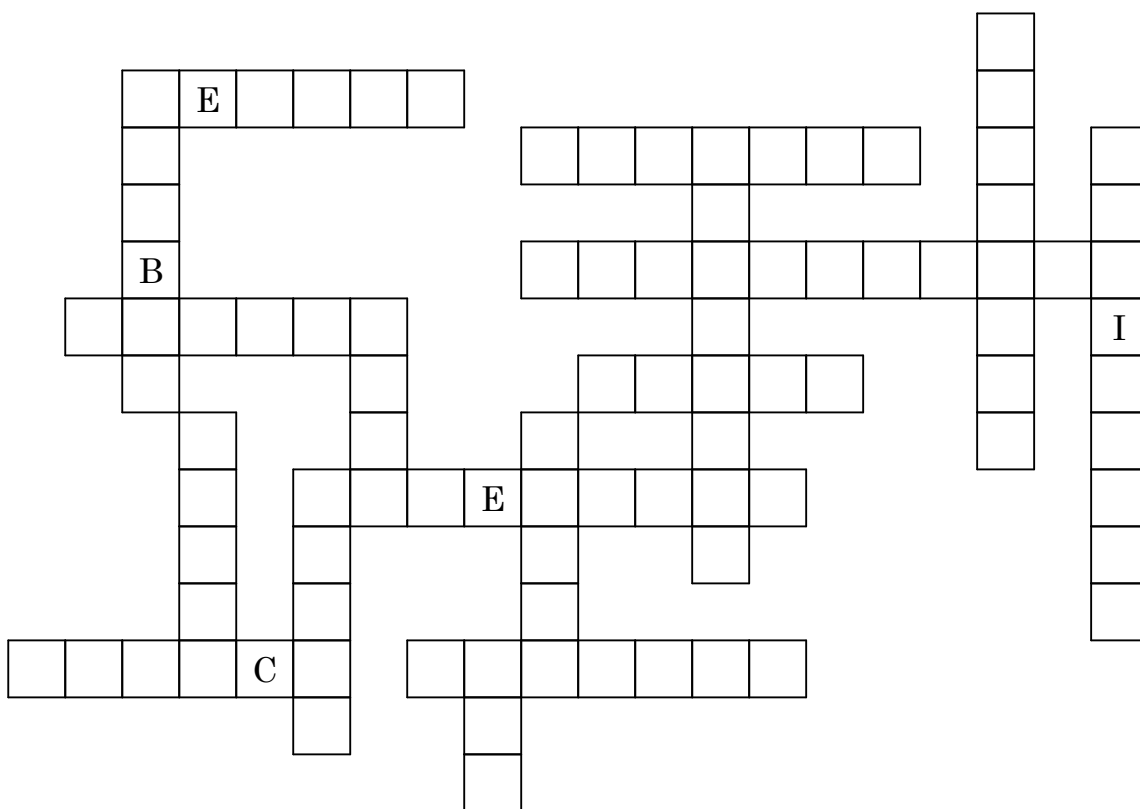

3 Letters
end

4 Letters
sins

5 Letters
Omega
voice

Alpha
power

6 Letters
elders
humble
hearts
church

7 Letters
hearken
confess

8 Letters
forgiven
merciful

9 Letters
assembled
beginning

11 Letters
everlasting

June 16–22

Doctrine and Covenants 64–66

“The Lord Requireth the Heart and a Willing Mind”

Reverse Word Search

Instructions: Instead of looking for words in a grid, place the bold words in the scripture in the empty word search puzzle. The words may be forwards, backwards, up, down, or diagonally. The start letter of the words have been placed in the grid to get you started.

Doctrine and Covenants 64:7–8

Nevertheless, he has **sinned**; but verily I say unto you, I, the Lord, **forgive sins** unto those who **confess** their sins **before** me and **ask forgiveness**, who have not sinned unto **death**. My **disciples**, in days of **old**, sought **occasion** against one **another** and forgave **not** one another in their **hearts**; and for this **evil** they were **afflicted** and **sorely chastened**.

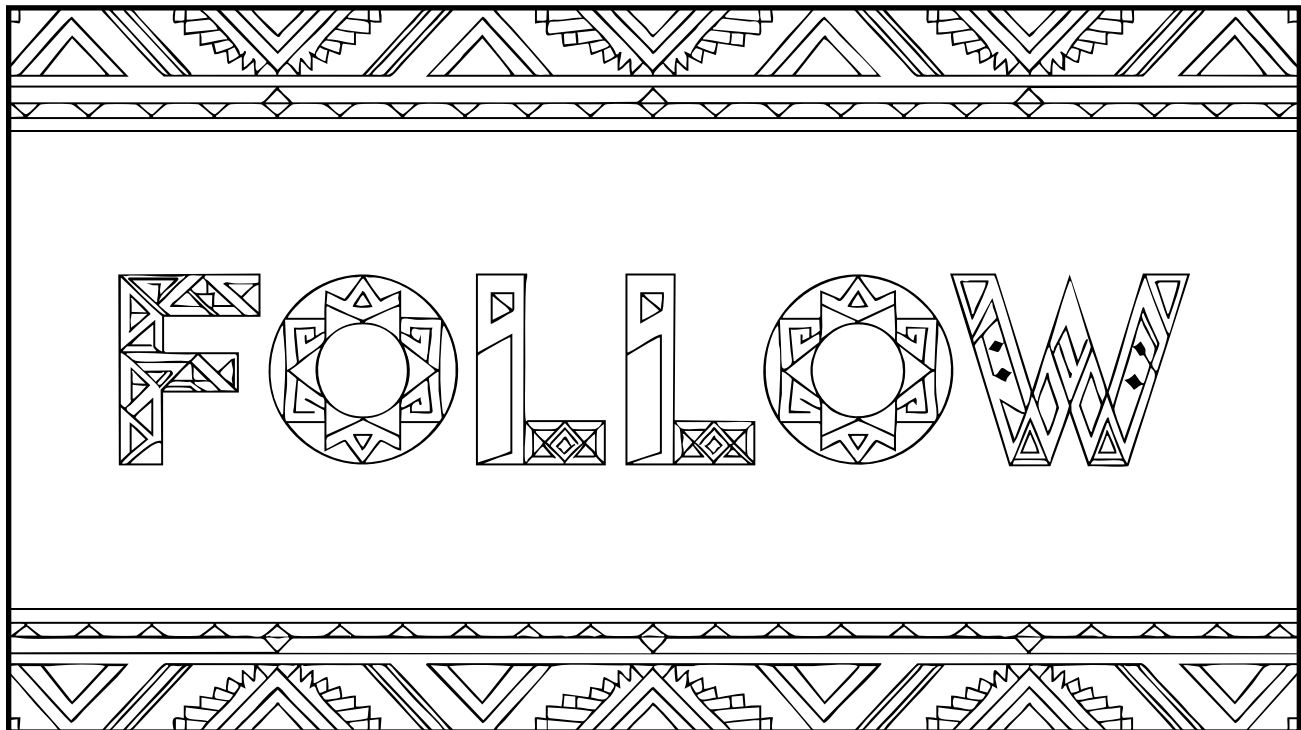
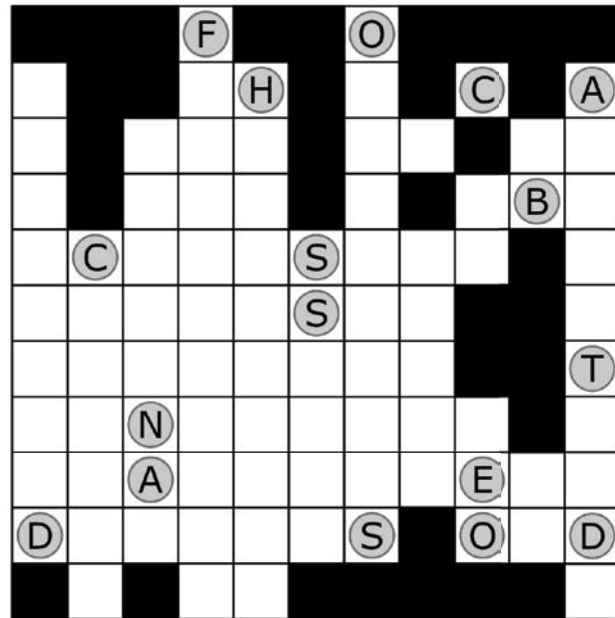

I can follow Jesus with my heart and mind.

Come, Follow Me 2025 Manual

June 16–22

Doctrine and Covenants 64–66

“The Lord Requireth the Heart and a Willing Mind”

Word Search

Instructions: Find the bold words from the scripture in the word search puzzle. Each word could be hidden forwards, backwards, up, down, or diagonally.

Doctrine and Covenants 64:9-10

Wherefore, I say unto you, that ye **ought to forgive one another**; for he that forgiveth **not** his **brother** his **trespasses standeth condemned before the Lord**; for there **remaineth** in him the **greater sin**. I, the Lord, will forgive whom I **will** forgive, but of you it is **required** to forgive all men.

L I H R E H T O R B D F E R Q
H Q Y B Y U E A Q Y E A R E F
M K M J E U I T V X N F S Q W
A E R R X F P R X A M F D U K
Z I S T A N D E T H E C Y I S
N O T E X T G S H O D S A R U
R E H T O N A P T Y N Y C E K
W V J L F E E A E X O E P D F
M J S S O R L S N T C F R G O
H B K U O L W S I S K E C T R
I Y G F P O N E A H T D X L G
S H E Y C R I S M A E B L F I
T B W R E D S U E K M I L J V
L E H N N U M R R W W O G S E
L S Q D G P G Q M O Q T Q H R

Unscrambler

Instructions: Unscramble the words below; look at the bold words in the scripture for a hint.

Doctrine and Covenants 64:33

Wherefore, be **not weary** in **well-doing**, for ye are **laying** the **foundation** of a **great work**. And **out** of **small things proceedeth** that which is **great**.

rywea _____

atgre _____

hproceedet _____

glayin _____

lsmal _____

tno _____

tou _____

tgrea _____

onfoundati _____

sthing _____

gwelldoin _____

kwor _____

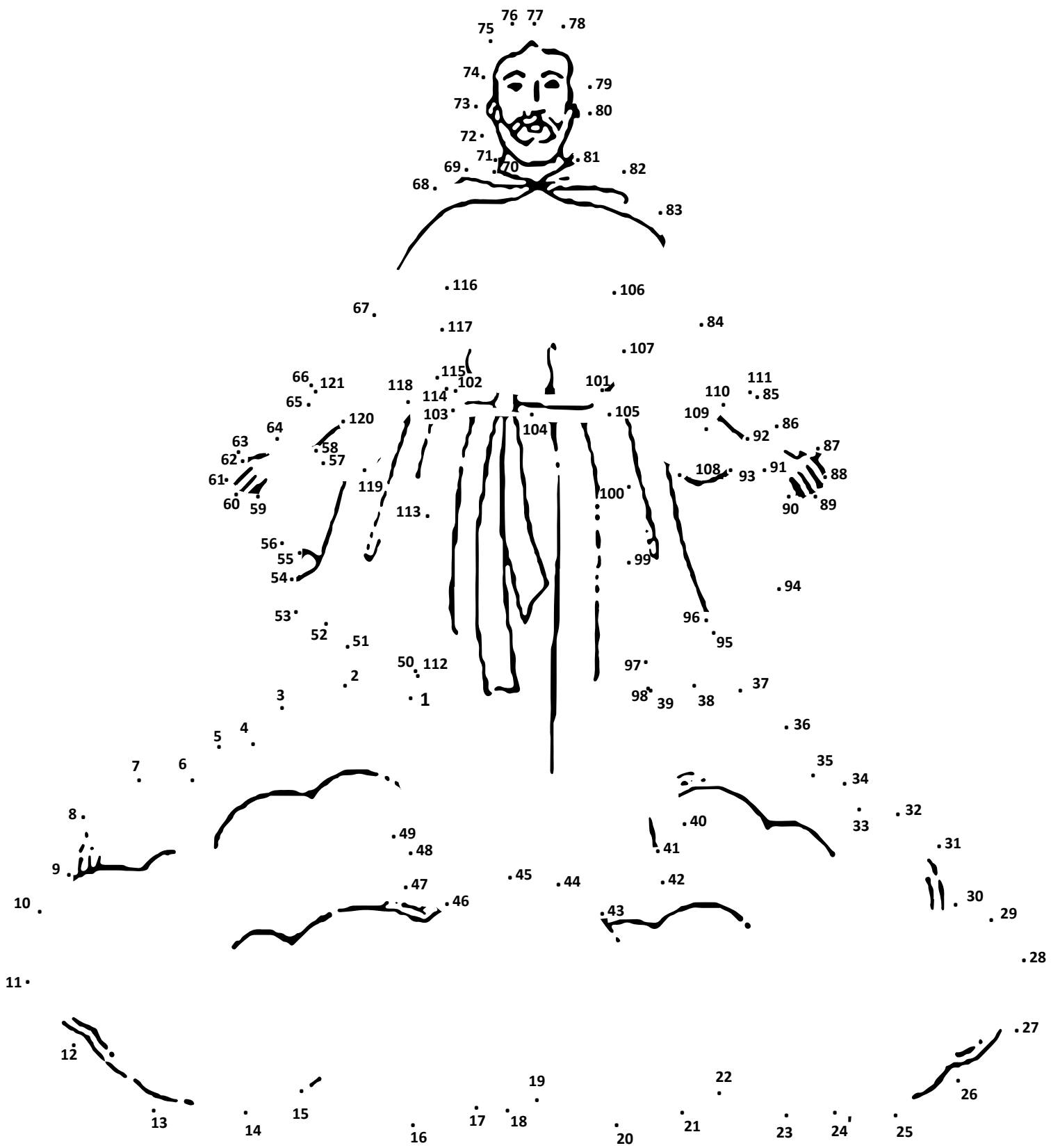

June 16–22

Doctrine and Covenants 64–66

“The Lord Requireth the Heart and a Willing Mind”

mormoncartoonist.com

© Arie Van De Graaff

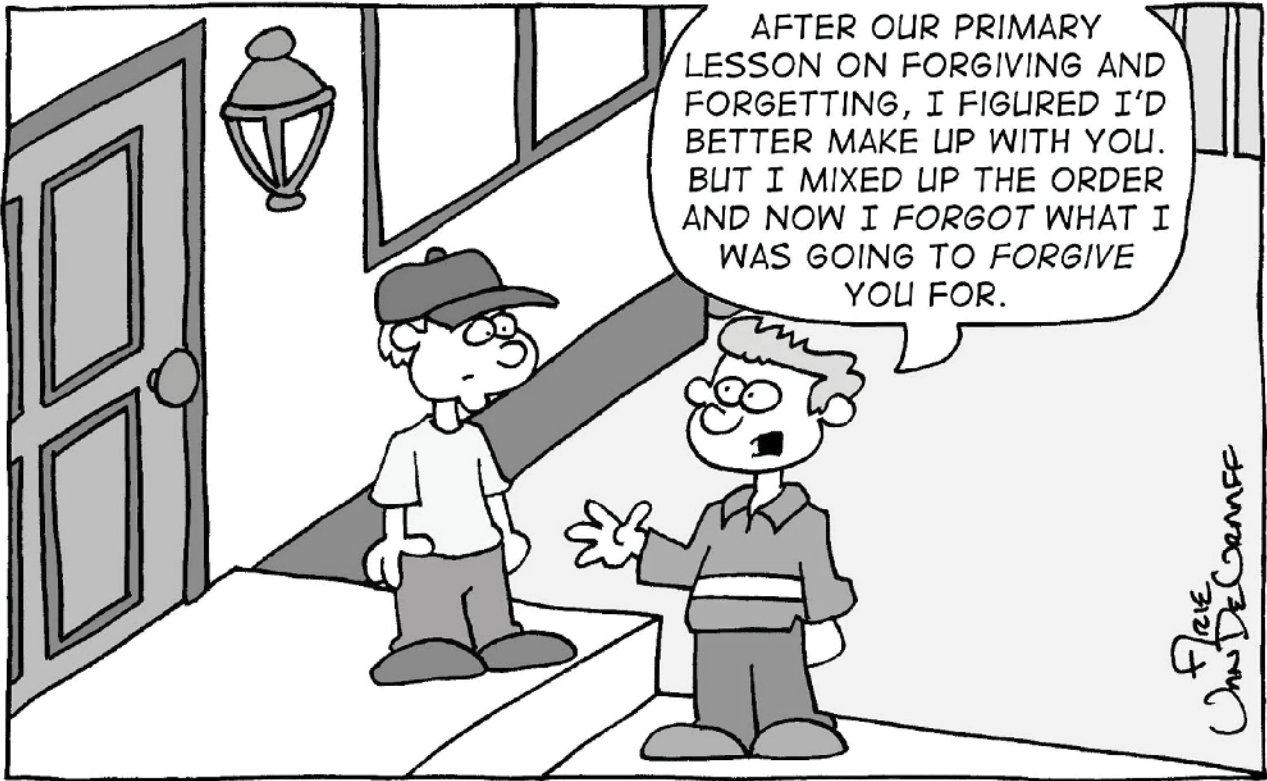

Translation Station

Instructions: Translate the sign language letters below into English to discover the hidden message. Write the alphabet letter beneath each hand sign. Use the key at the back of the book to help you.



June 16-22

Doctrine and Covenants 64-66

“The Lord Requireth the Heart and a Willing Mind”

God’s “great work” is built on “small things.”

Come, Follow Me 2025 Manual

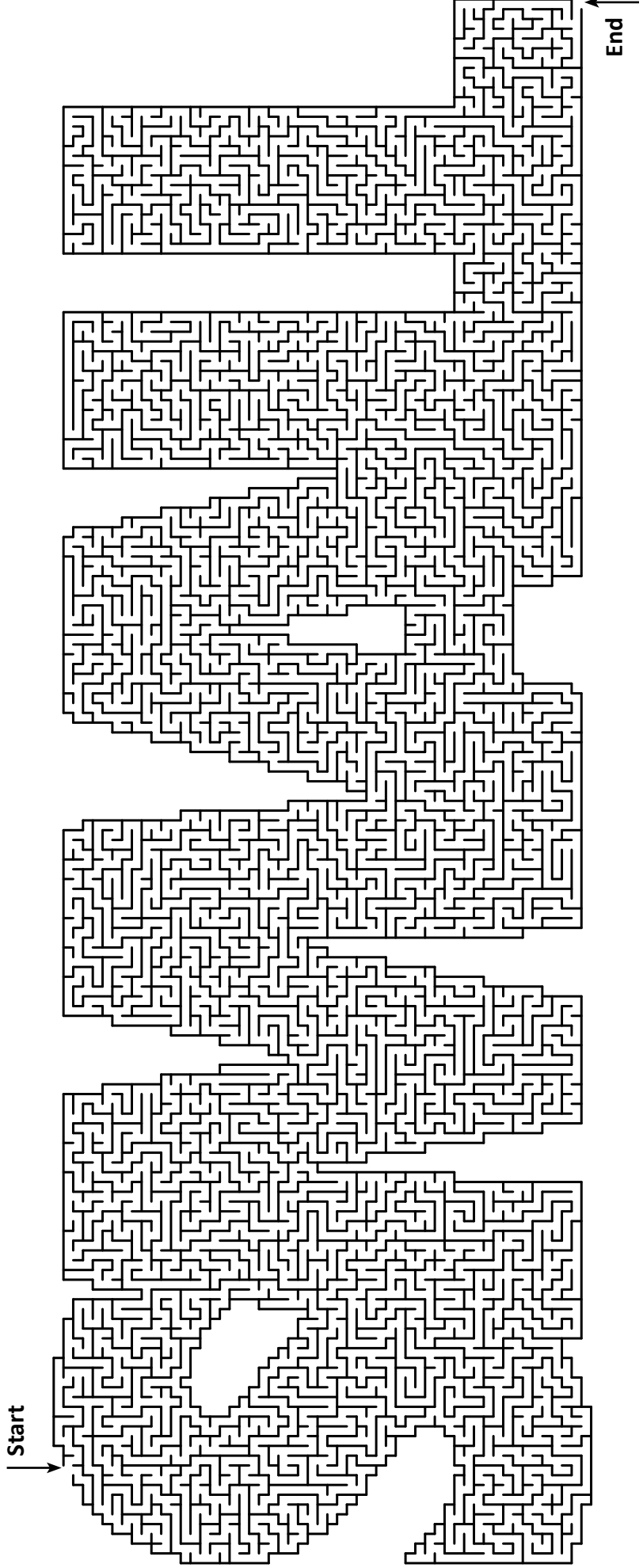

June 16–22

Doctrine and Covenants 64–66

“The Lord Requireth the Heart and a Willing Mind”

Word Sudoku

Instructions: Solve this word sudoku puzzle the same way that you’d solve a numeric sudoku. Each of the bold words in the scripture below is found once in every row, column and 3×3 box.

Doctrine and Covenants 64:34

Behold, the Lord requireth the **heart** and a willing **mind**; and the willing and **obedient** shall **eat** the **good** of the **land** of **Zion** in these **last days**.

mind				days		Zion	obedient	
				eat	last	days	mind	
			Zion	mind	heart			last
	last	mind		Zion				eat
heart					eat	mind		Zion
eat	land				good		heart	
	heart		days	good		land		
obedient				heart	Zion			good
days				land		heart	last	

June 23–29

Doctrine and Covenants 67–70

“Worth ... the Riches of the Whole Earth”

Missing Vowels Word Search

Instructions: Find the hidden words. The words have been placed horizontally, vertically, diagonally, forwards, or backwards, and the vowels have been removed. When you locate a word, draw an ellipse around it and fill the vowels in.

Doctrine and Covenants 68:25

And again, inasmuch as **parents** have **children** in **Zion**, or in any of her **stakes** which are organized, that **teach** them **not** to **understand** the **doctrine** of **repentance**, **faith** in **Christ** the Son of the **living** God, and of **baptism** and the **gift** of the **Holy Ghost** by the **laying** on of the **hands**, when **eight years** old, the **sin** be upon the **heads** of the parents.



Knight Moves - Find a Word

Instructions: Start with any letter in the puzzle to see if it's the beginning of a word. To get to the second letter, jump two squares in any direction except diagonally, and then one square in a different direction. Your path will look like a capital L. Only one route through the puzzle will make a word. Write the letters of the word you discover in the blanks below as you jump through the squares:

1 2 3 4 5 6 7 8

Now can you find this word in the following scripture?

Doctrine and Covenants 69:1

f	f	i
t		l
u	a	h

Saving the Book of Commandments

By Arie Van De Graaff

When a mob destroyed the press that was printing the Book of Commandments, sisters Mary Elizabeth and Caroline Rollins risked their lives to save several pages of the book. These revelations were later printed in the Doctrine and Covenants.

To find out what trait these two sisters showed, match the number of pages in each stack with the matching number at the bottom of the page. Then write the letters in the right spots.



Printing the Doctrine and Covenants

Help Joseph Smith through the maze to the printing press so he can print the first copy of the Doctrine and Covenants.

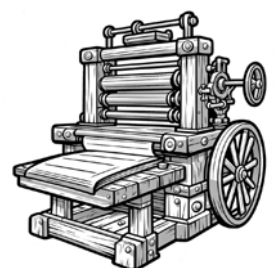
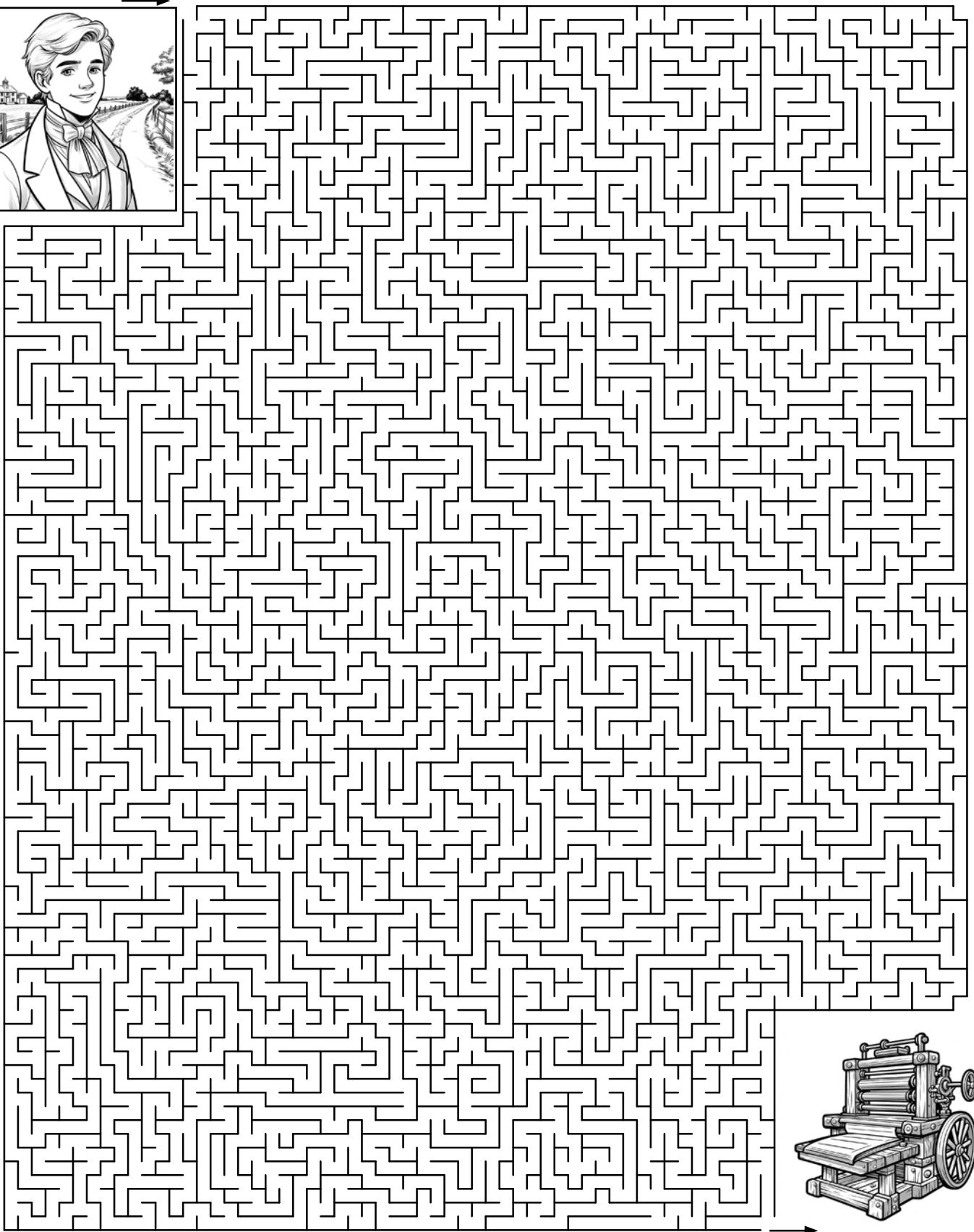

June 23–29

Doctrine and Covenants 67–70

“Worth ... the Riches of the Whole Earth”



Word Square

Instructions: Word squares are a liike Sudoku puzzles, but each letter can occur only once in each row and in each column. Check your puzzle against the answer key on ColorMeChristian.org. Every row and column must contain every letter in the word **IDLER**. This word can be written in the gray row.

Doctrine and Covenants 68:29-30

And the inhabitants of Zion shall also observe the Sabbath day to keep it holy. And the inhabitants of Zion also shall remember their labors, inasmuch as they are appointed to labor, in all faithfulness; for the **idler** shall be had in remembrance before the Lord.

L				E
R				
	R		I	
	I			R
			D	

June 30–July 6

Doctrine and Covenants 71–75

“No Weapon That Is Formed against You Shall Prosper”

Word Spiral

Instructions: Fill in the blank puzzle grid using the bold words from the scripture or phrase below. *The bold words may not all be used!* Use the letter hint below and count the letters of the bold words to figure out where each word goes. Then transfer the letters that have little numbers in their box to the hidden word at the bottom of the puzzle. Check the answer on ColorMeChristian.org.

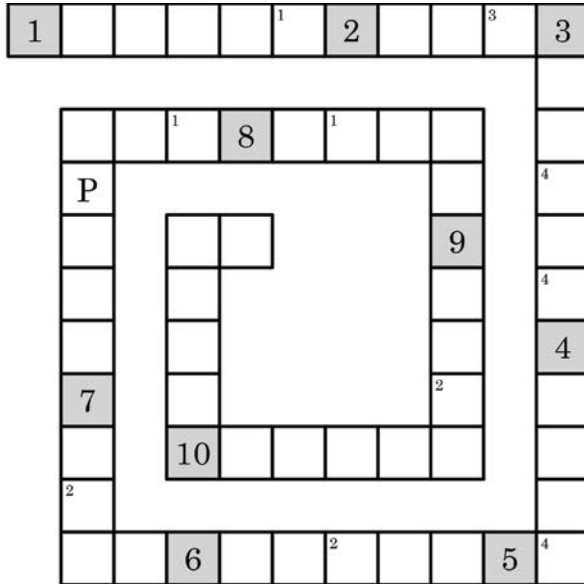

Stand for the Right
Children’s Songbook

Our **prophet** has **some words** for you,
And **these** are the words: “Be **true**, be
true.” At **work** or at **play**, In **darkness** or
light, Be true, be true, And **stand** for the
right.

Letter Sudoku

Instructions: Solve the letter sudoku puzzle the same way you’d solve a numeric sudoku. Check your puzzle against the answer key on ColorMeChristian.org. Every column, row, and group of nine must contain every letter in the word(s) **VINEYARD**.

Doctrine and Covenants 72:2

For verily thus saith the Lord, it is expedient in me for a bishop to be appointed unto you, or of you, unto the church in this part of the Lord’s **vineyard**.

	N				I	A	
	A			R			
I			A		R	Y	
			Y	A		V	
N	E		I			R	A
R	D		V		Y	I	
A	I						V
V						N	

Mystery Picture Graph

Instructions: Find the mystery picture below by plotting and connecting the points of each line on the coordinate graph. Connect all the points in Line 1, stop, pick up your pencil, and then connect all the points in Line 2, and so on for the rest of the lines. The dot for the first (X,Y) coordinate pair on Line 1 has been placed for you.

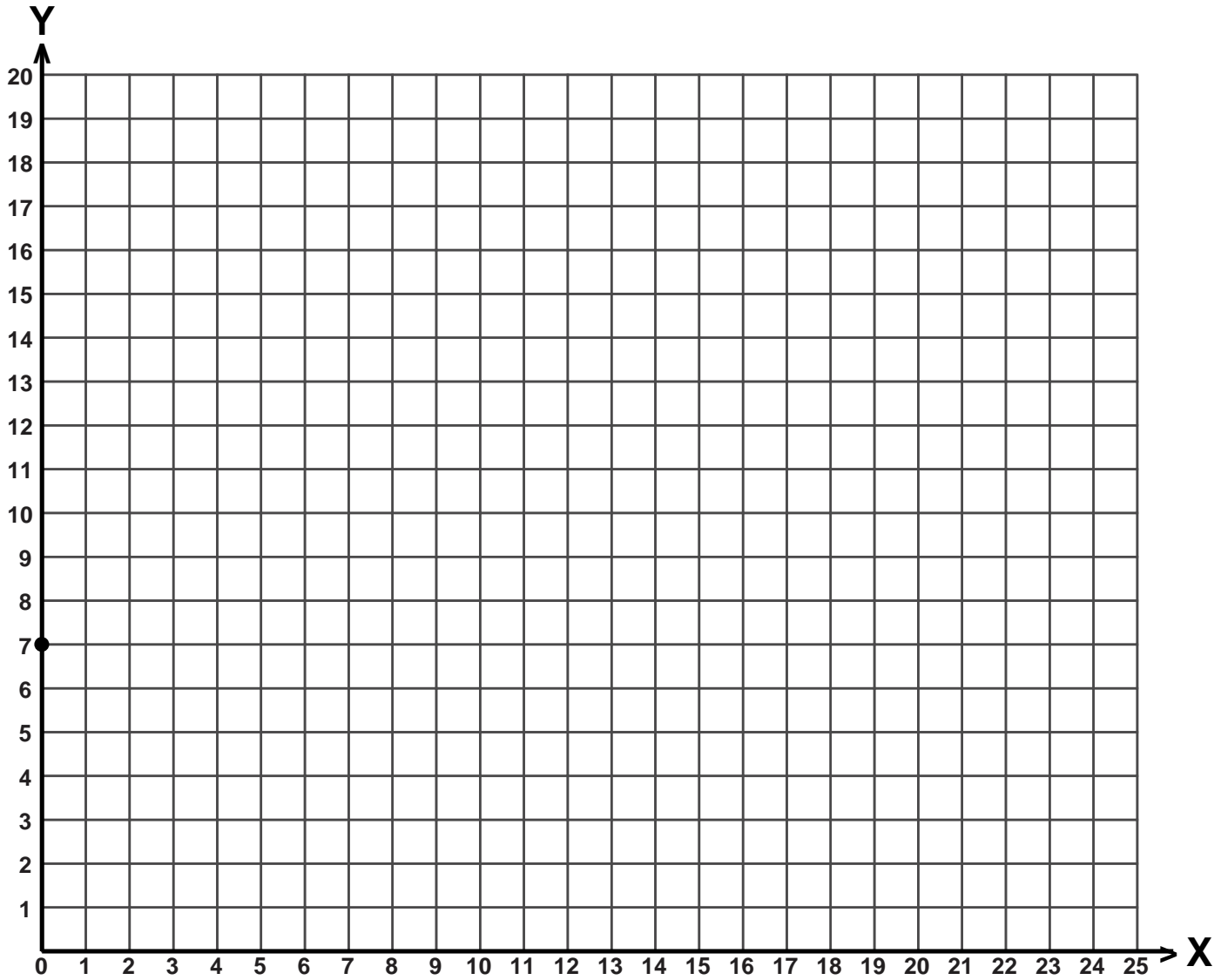

Line 1	(0, 7)	(14, 0)	(19, 8)	(19, 9)	(21, 9)	(21, 16)	(9, 16)	(6, 17)	(4, 15)	(0, 7)	Line 2	(4, 15)	
	(5, 13)	(16, 8)	(19, 8)	Line 3	(1, 9)	(5, 13)	Line 4	(16, 8)	(15, 2)	Line 5	(9, 16)	(6, 16)	(6, 13)
Line 6	(14, 9)	(19, 9)	Line 7	(7, 12)	(7, 13)	(8, 14)	(9, 14)	(10, 13)	(10, 12)	(9, 11)	Line 8	(19, 15)	
(19, 10)	Line 9	(18, 15)	(18, 10)	Line 10	(17, 15)	(17, 10)	Line 11	(16, 15)	(16, 10)	Line 12	(15, 15)	(15, 10)	
Line 13	(14, 15)	(14, 10)	Line 14	(13, 15)	(13, 10)	Line 15	(12, 10)	(12, 11)	(11, 12)	(10, 12)	Line 16	(7, 15)	
(7, 13)	Line 17	(8, 15)	(8, 14)	Line 18	(9, 15)	(9, 14)	Line 19	(10, 15)	(10, 13)	Line 20	(11, 15)	(11, 12)	
Line 21	(12, 15)	(12, 11)											
Draw circles or big dots on the following points:							(20, 15)	(20, 14)	(20, 13)	(20, 11)	(20, 10)		

June 30–July 6

Doctrine and Covenants 71–75

“No Weapon That Is Formed against You Shall Prosper”

Wacky Word Trails

Instructions: Start with the circled letter, use the clues to find and mark the trail of letters of all the connected bolded words from the scripture through the maze to the last letter. The path can wander up, down, left, and right at any point, even in the middle of the word.

Doctrine and Covenants 71:9-11

Verily, thus **saith** the **Lord** unto you—there is no **weapon** that is **formed against you** shall **prosper**; And if any **man lift** his **voice against** you he shall be **confounded** in **mine own due time**. Wherefore, **keep** my **commandments**; they are **true** and **faithful**.

A Q G B T O J Z A G A D Y Y X
C W O E U R W N I **K** S T N E M
N A E W L T Q S E E E O M N D
O P R D U F H T I O P C M A I
K L O F A I T S E O B V X X O
D T S N R T I A M I J S Q W Z
U G A I Q H O W N N E R I B I
U A H L Y D Z T X E V Y L G W
O I M V Z Z G P L S Z C O X R
Y M L A H P E L Z O B Z N F C
E A E M H W M B O H X R A O F
U D D R O Q W J T J G O C U N
R E R V F Z Y V M I T R E P D
J P L G N A M H E V O I O S E
H N S Z S K T F I L E C R P D

Handwriting Practice

Practice your handwriting by tracing the sentence below. Then use the blank lines to write the sentence on your own.

*I can give my best effort to
the Lord.*

Blank handwriting practice lines consisting of a solid top line, a dashed middle line, and a solid bottom line, repeated five times.

June 30–July 6

Doctrine and Covenants 71–75

“No Weapon That Is Formed against You Shall Prosper”

Instructions: Connect all of the letters in the maze and then write the phrase in the blanks below. Don't be tricked by letters that take you into a dead end! There is only one path through the maze.

-----,
-----,

Doctrine and Covenants 75:3

Finish

G	B	T	B	E	H	O	L	D	O	H	O	U	F	O	G	O	F	O	R	T	G	O	F	
I	G	H	T	B	E	L	D	I	S	S	H	O	U	L	D	G	O	F	O	R	D	G	O	
M	I	G	B	E	L	D	I	U	S	U	S	H	O	U	L	D	G	O	F	U	L	D	G	
R	G	H	E	H	O	R	M	O	U	O	U	S	H	O	U	L	Y	O	U	O	U	L	D	
U	O	U	H	Y	O	U	H	Y	T	Y	O	U	L	A	H	A	T	Y	S	H	O	U	L	
O	Y	O	T	H	Y	H	T	T	A	T	Y	O	L	L	T	H	A	T	U	S	H	O	U	
Y	H	T	I	W	R	T	I	A	H	A	T	Y	I	L	L	T	T	Y	O	U	S	H	O	
U	T	H	A	B	O	I	W	H	T	H	A	I	W	I	L	L	A	T	Y	O	U	S	H	
B	U	T	L	A	B	O	R	T	L	M	S	W	Y	W	I	T	H	A	T	Y	O	U	S	
E	B	U	T	L	A	B	O	L	L	S	I	S	M	Y	W	I	L	L	A	T	Y	O	U	
L	U	T	L	A	B	W	R	L	I	M	T	I	S	M	Y	W	I	L	H	A	T	Y	O	
D	L	E	A	B	Y	H	L	I	W	Y	I	T	I	S	M	Y	L	L	T	H	A	T	Y	
I	D	L	B	O	T	T	L	L	I	W	T	I	S	M	Y	W	I	L	L	T	H	A	T	
E	I	D	L	T	A	H	T	F	O	R	A	T	I	Y	L	I	L	L	T	H	A	O	Y	
B	D	H	S	U	O	A	H	O	F	O	H	A	T	I	T	I	S	M	Y	W	I	L	O	
R	B	E	I	O	Y	T	A	G	O	R	T	H	A	T	I	S	M	I	W	I	L	L	U	
E	R	H	S	U	O	Y	T	D	H	T	U	T	T	I	T	I	S	M	Y	W	L	T	S	
H	E	R	E	N	U	O	Y	L	U	H	O	U	T	T	I	T	I	S	M	Y	W	I	L	
T	H	E	N	Y	R	U	O	U	O	A	Y	O	U	T	T	I	T	I	S	M	Y	T	H	
I	T	N	Y	R	R	S	U	S	H	N	O	Y	T	H	A	T	I	T	W	I	L	L	T	
E	N	Y	R	R	A	T	T	O	N	D	T	O	H	A	T	I	T	M	Y	W	I	L	L	
Start	B	E	H	O	L	D	I	S	A	Y	U	N	T	A	T	I	T	I	S	M	Y	W	I	L

June 30–July 6

Doctrine and Covenants 71–75

“No Weapon That Is Formed against You Shall Prosper”

Instructions: Using the Across and Down clues, write the correct words in the numbered grid below. Hint: all of the words in the crossword come from the scripture below.

Doctrine and Covenants 71

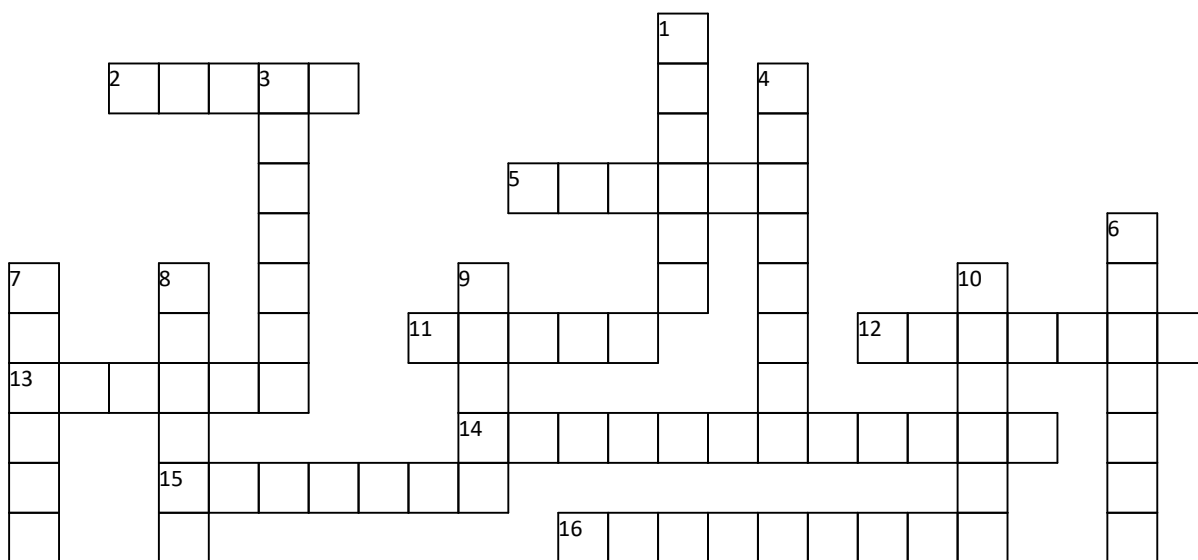

ACROSS

2. a painful feeling of embarrassment or inadequacy
5. any instrument used in fighting or hunting
11. the ability to do something or act in a particular way
12. flourish; make steady progress and growth
13. one of the natural periods into which the year is divided
14. the laws and requirements that God gives to mankind, either individually or collectively
15. make ready or suitable or equip in advance
16. something that baffles understanding and cannot be explained (plural)

DOWN

1. God's plan of salvation, made possible through the Atonement of Jesus Christ
3. an important assignment carried out for God
4. a farm of grapevines where wine grapes are produced
6. a personal foe
7. the quality of having experience, knowledge, and good judgment
8. the first prophet of this final dispensation
9. the sound produced in a person's larynx and uttered through the mouth, as speech or song
10. the natural opening through which food passes into the body (plural)

July 7-13

Doctrine and Covenants 76

“Great Shall Be Their Reward and Eternal Shall Be Their Glory”

Translation Station

Instructions: Translate the Morse code below into English to discover the hidden message. Write the alphabet letter beneath each Morse Code letter. Each letter, number, and punctuation is separated by a slash: /. Use the key at the back of the book to help you.

-. / / . - / - / - / - / - - / / . . / - - / - - - / . - / - . / - . . . /
-. / / . - . / - / . - . / - / / / . . / - - / - - - /
. - / - . / - . . . / - / / / . . / - - / - - - / - / / . /
. - / - / / / / . - / . - . . / . / . - / - . / - . . . /
. - / . / / . / - / / . / . - / - / . / - - - /
. - / - . / - . . . / - / / . / . . / - . / / . - / - / . . / - . - / - /
-. / / . / / . / - / / . - / / . /
-. . . . / . / - . . . / - / - / - / . / - . / . . . / - / - . / / . - / - . / - . . . /
-. . . / . - / / - / / - / . / / / . . . / - . / - / - /
-. . . . / - / - / / - . . . / - / - / - / / . . / - . . . /
. - / - . / - . . . / - / - / / . / - . / . - / - . / - /
-. / - / - / - / - /

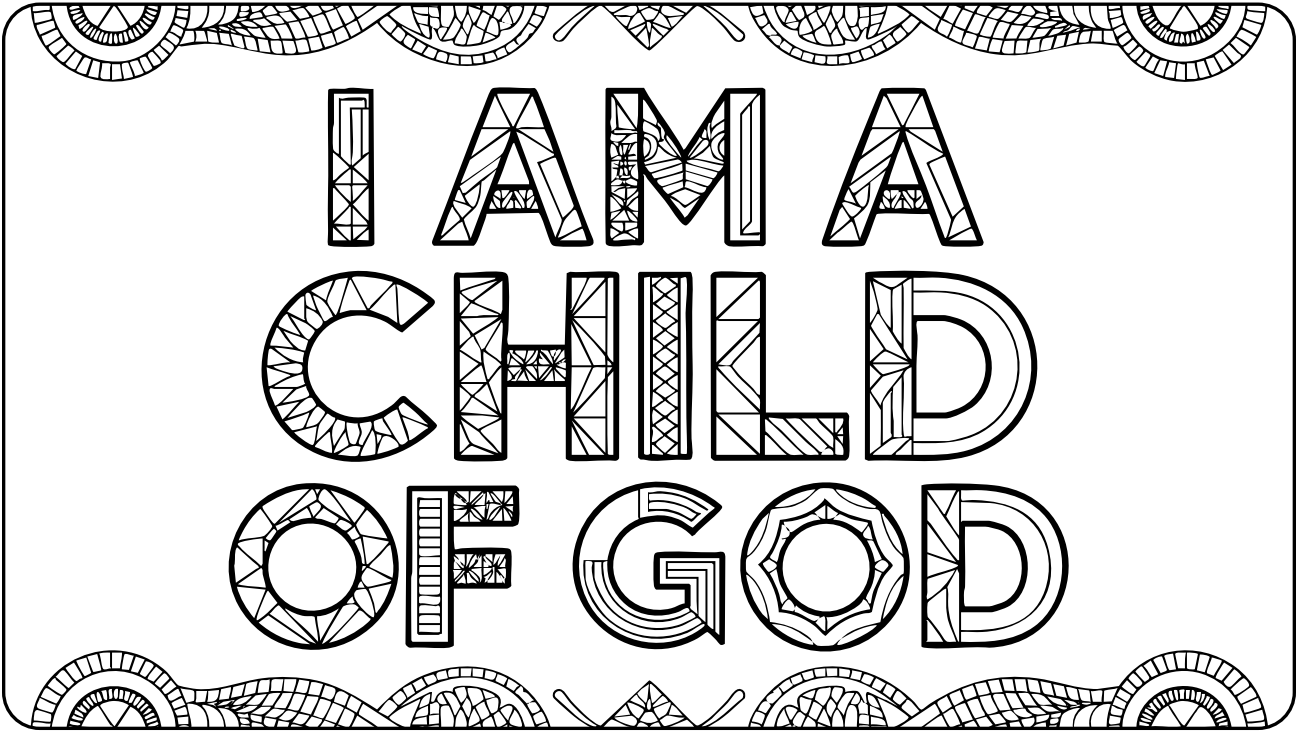

July 7–13

Doctrine and Covenants 76

“Great Shall Be Their Reward and Eternal Shall Be Their Glory”

Word Angles

Instructions: Find the bold words from the scripture. Each word path may run north, east, south, or west, may make one right-angled turn, and may cross another word path. A few words may make no right angle turn at all.

Doctrine and Covenants 76:5, 69

For thus saith the Lord—I, the Lord, am **merciful** and **gracious** unto those who **fear** me, and **delight** to **honor** those who **serve** me in **righteousness** and in **truth** unto the **end**....**These** are **they** who are **just** men made **perfect** through **Jesus** the **mediator** of the **new covenant**, who **wrought** out this **perfect atonement** through the **shedding** of his **own blood**.

L	N	H	O	W	T	C	E	F	K	T	R	U	T	H	W
U	K	G	D	I	N	G	B	R	B	J	W	S	B	D	B
F	K	C	D	Z	K	Q	L	E	W	W	R	B	P	P	U
I	C	R	E	M	G	V	O	P	N	N	O	U	G	H	T
E	S	E	H	T	R	F	O	O	U	S	N	E	S	S	G
M	Z	P	S	J	A	P	D	E	T	N	E	N	D	T	U
D	I	S	O	E	C	H	K	T	D	H	M	R	C	R	O
Q	D	S	U	S	I	N	E	H	R	C	E	B	F	T	T
R	O	N	O	M	O	S	Z	G	C	C	N	P	I	X	A
A	U	X	H	T	U	S	L	I	O	O	O	H	Q	Y	I
T	R	R	E	V	R	E	B	R	P	V	T	L	U	J	D
H	X	H	R	A	E	F	Y	R	E	E	A	K	S	Z	E
G	B	P	J	Y	R	F	E	C	T	N	J	V	T	H	M
I	L	E	D	B	E	N	E	E	F	A	C	F	Y	K	J
I	K	X	N	W	P	R	W	C	V	N	T	X	E	H	T
G	Z	L	Z	O	Q	H	O	L	A	L	L	Y	X	Z	F

Fill in the Blank

Doctrine and Covenants 76:41–42

That he _____ into the _____, even _____, to be _____ for the world, and to _____ the _____ of the world, and to _____ the world, and to _____ it from all _____; That through _____ all might be _____ whom the _____ had put into his _____ and _____ by him;

world	Father	cleans	saved	power	sins
made	Jesus	came	him	bear	unrighteousness
sanctify	crucified				

©54

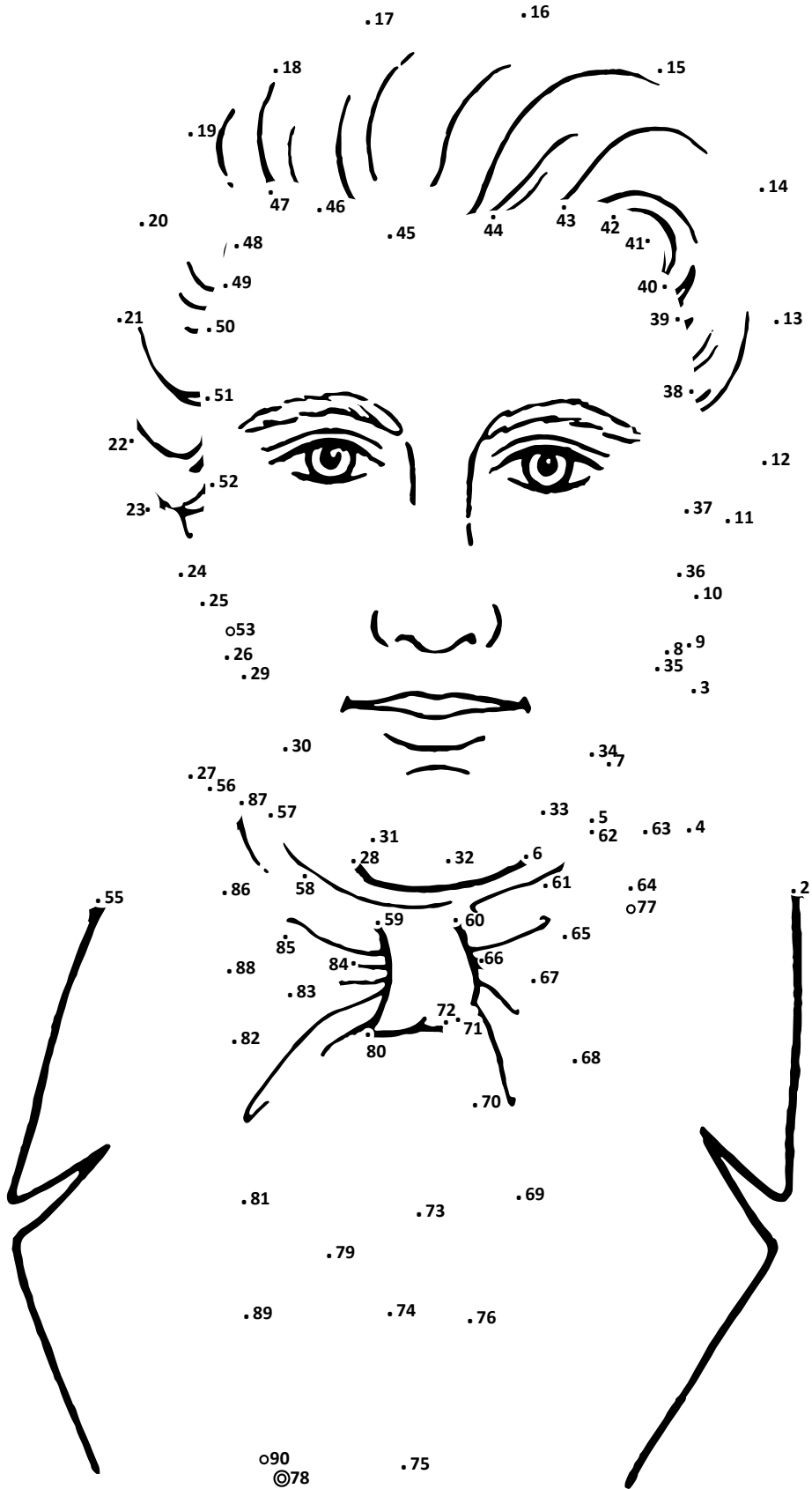

©1

Key
○ Stop. Pick up your pencil and go to the next dot.
◎ Start. Put your pencil down and draw the next line.

July 7-13

Doctrine and Covenants 76

“Great Shall Be Their Reward and Eternal Shall Be Their Glory”



Letterbox Puzzle

Instructions: Find the hidden word in the puzzle below by crossing out all letters that occur twice or more. Capitalized and lowercase letters count as unique letters for this puzzle. The letters left over will form a word. Write down the left over letters like you would read a book, from left to right and top to bottom. Then find the hidden word in the scripture or phrase below and circle it.

Doctrine and Covenants 76:12

By the power of the Spirit our eyes were opened and our understandings were enlightened, so as to see and understand the things of God—

Write the hidden word:

y	Q	g	P	A	n
K	j	p	Z	O	s
W	l	s	E	p	A
Q	c	y	U	d	K
†	†	n	d	U	Z
K	g	c	j	R	l

July 7–13

Doctrine and Covenants 76

“Great Shall Be Their Reward and Eternal Shall Be Their Glory”

Heavenly Father wants me to return to live with Him forever.

Come, Follow Me 2025 Manual

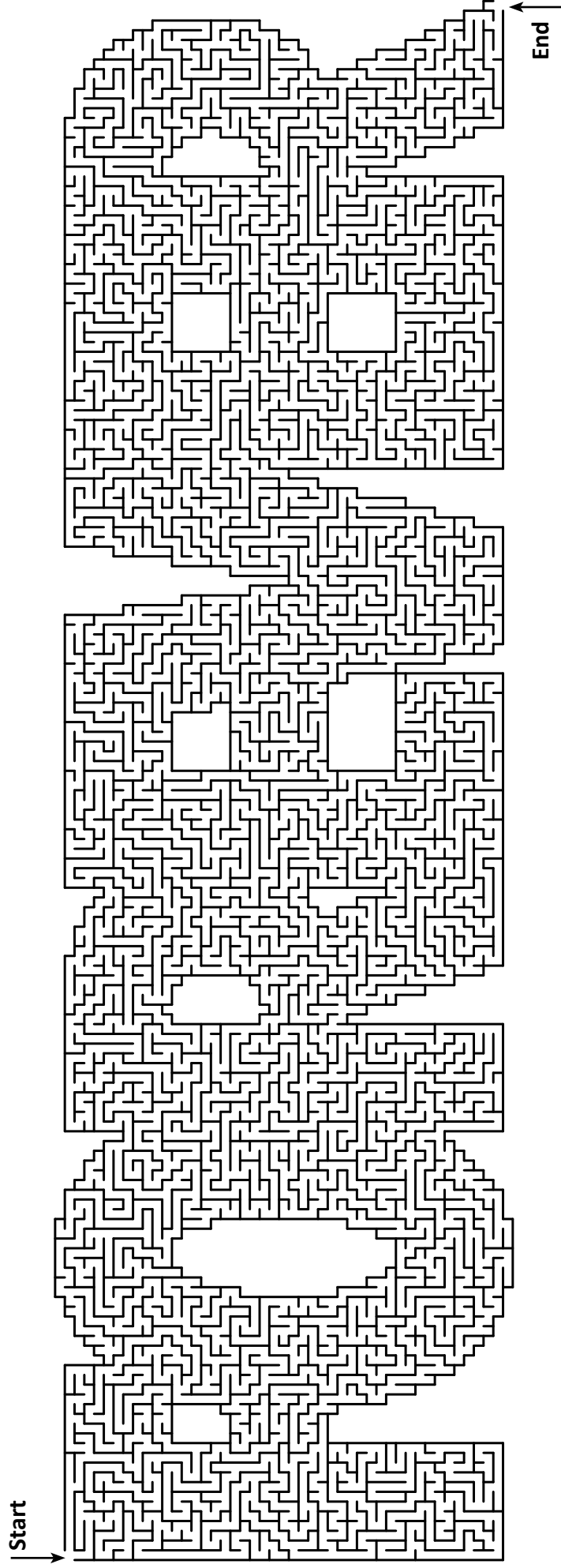

July 7–13

Doctrine and Covenants 76

“Great Shall Be Their Reward and Eternal Shall Be Their Glory”

Instructions: Fit the bold words from the scripture below into the encircled squares. Words will read forward, backward, up, down, and diagonally and will normally cross other words. Start with the hints provided.

Doctrine and Covenants 76:114–116

But **great** and **marvelous** are the **works** of the Lord, and the **mysteries** of his **kingdom** which he showed unto us, which surpass all **understanding** in **glory**, and in **might**, and in **dominion**; Which he commanded us we should not write while we were yet in the Spirit, and are not **lawful** for man to **utter**; Neither is man **capable** to make them **known**, for they are only to be **seen** and **understood** by the **power** of the **Holy Spirit**, which God **bestows** on those who **love** him, and **purify** themselves before him;

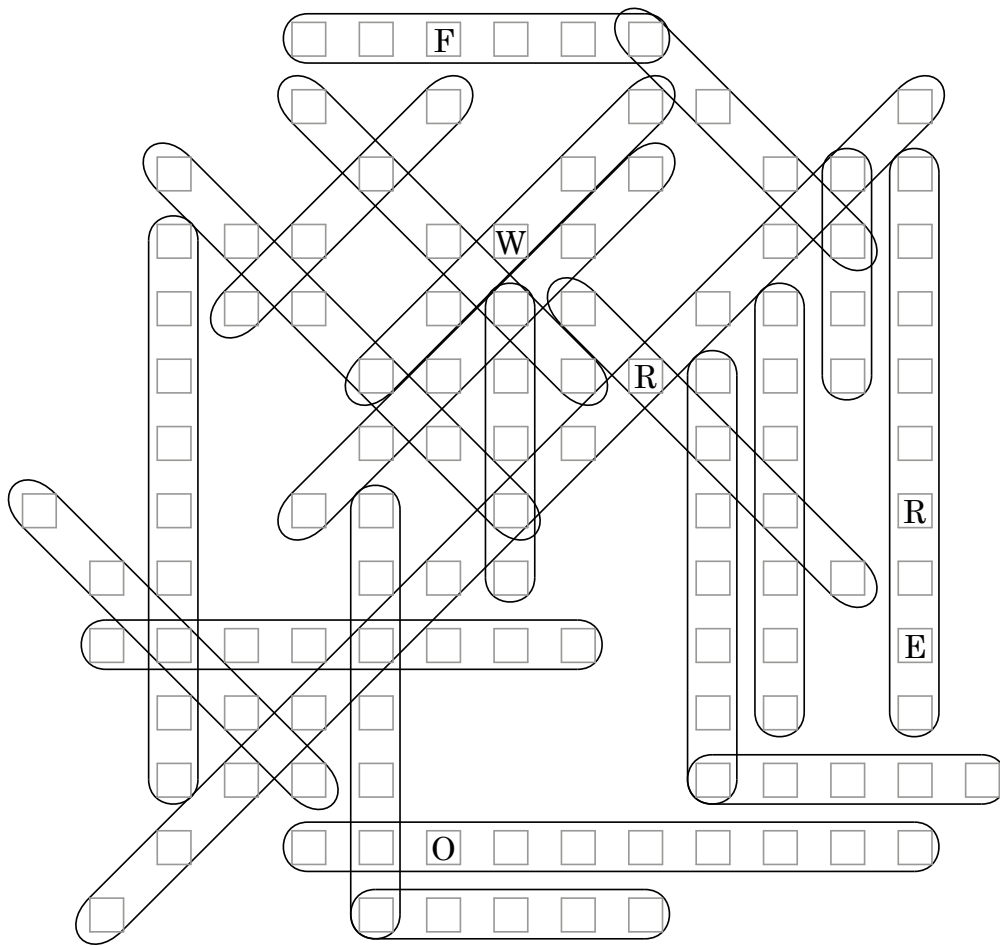

great
understanding
utter
power
purify

marvelous
glory
capable
Holy

works
might
known
Spirit

mysteries
dominion
seen
bestows

kingdom
lawful
understood
love

July 14–20

Doctrine and Covenants 77–80

“I Will Lead You Along”

Word Search

Instructions: Find the bold words from the scripture in the word search puzzle. Each word could be hidden forwards, backwards, up, down, or diagonally.

Doctrine and Covenants 78:19

And he **who receiveth all things** with **thankfulness** shall be **made glorious**; and the things of **this earth** shall be **added unto him**, even an **hundred fold**, yea, **more**.

R	E	C	E	I	V	E	T	H	V	E	D	A	M	X
H	O	A	Z	H	R	O	M	H	T	R	A	E	V	L
K	L	S	T	H	K	L	O	Z	W	F	L	S	D	F
L	C	D	R	H	K	J	R	N	O	Y	Q	A	L	E
U	H	M	T	I	A	H	E	L	G	T	P	L	C	O
E	O	H	S	Q	L	N	D	H	B	H	A	R	R	H
S	I	D	B	Y	F	S	K	U	Q	H	D	P	U	W
S	T	Y	G	V	G	P	H	F	S	L	V	C	D	T
S	C	V	P	L	H	I	M	U	U	Y	R	J	H	M
F	D	I	F	G	O	Z	I	A	N	L	T	I	J	H
P	M	U	Q	A	Q	R	A	I	L	D	N	P	X	K
V	V	N	G	D	F	N	I	Y	P	G	R	E	I	M
Z	N	T	I	D	H	K	A	O	S	H	O	E	S	M
Z	M	O	F	E	W	C	N	N	U	Q	C	M	D	S
V	G	M	C	D	M	C	J	H	B	S	A	T	A	T

Word Star

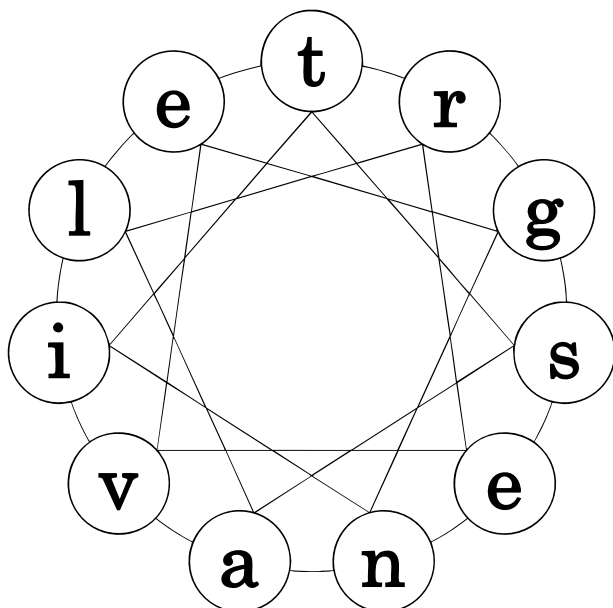

Instructions: Only one route through the word star will make a word. Try each letter and follow the pathway through the star to see if it makes a word.. IF you need a hint, look at the words in the scripture below. Write the letters of the word you discover in the blanks below as you travel through the star:

Now can you find this word in the following scripture?

Doctrine and Covenants 78:4

July 14–20

Doctrine and Covenants 77–80

“I Will Lead You Along”

Instructions: Fill in the blank puzzle grid using the word bank with the bold words from the scripture below. Place the words in the correct place on the grid.

Doctrine and Covenants 77:2

Q. What are we to **understand** by the **four beasts**, spoken of in the same verse? A. They are **figurative expressions**, used by the **Revelator, John**, in describing **heaven**, the **paradise** of God, the **happiness** of man, and of **beasts**, and of **creeping things**, and of the **fowls** of the air; that which is **spiritual** being in the likeness of that which is **temporal**; and that which is temporal in the likeness of that which is spiritual; the **spirit** of man in the **likeness** of his **person**, as also the spirit of the beast, and every other **creature** which God has **created**.

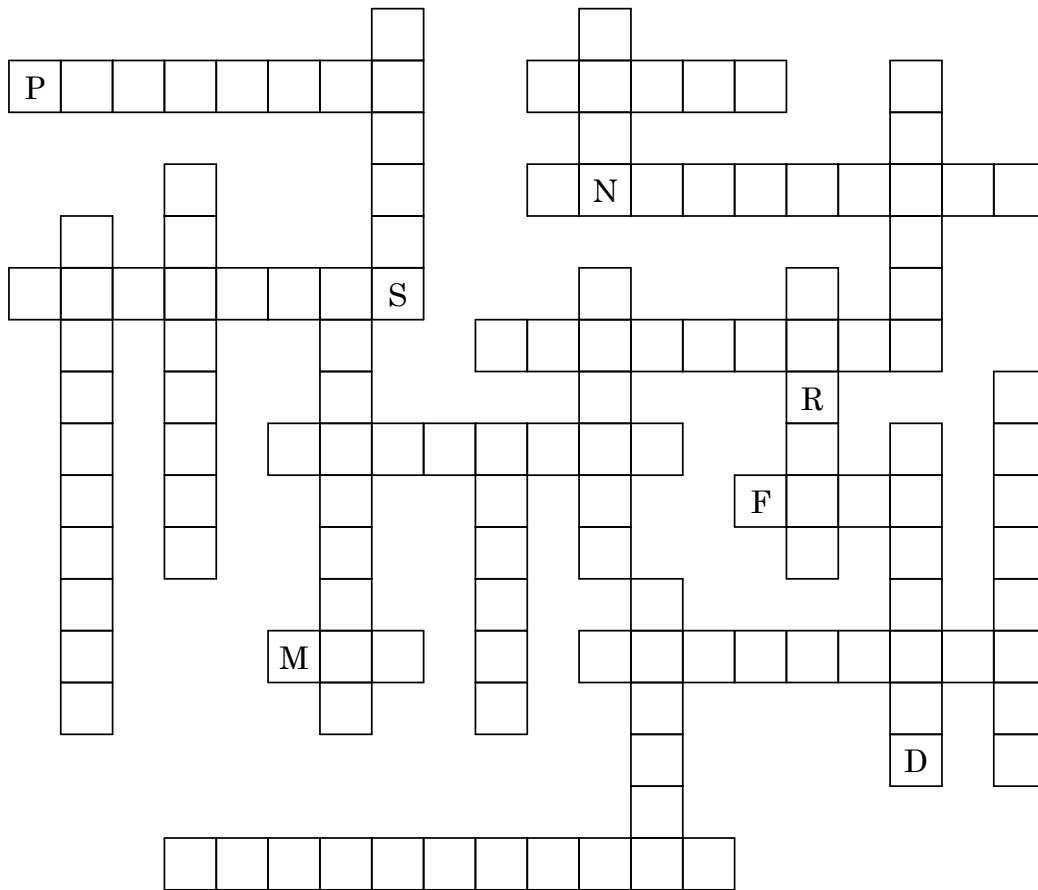

3 Letters man	6 Letters spirit person	7 Letters created	9 Letters spiritual happiness Revelator	11 Letters expressions
4 Letters four John	beasts beasts things heaven	8 Letters creature likeness creeping paradise temporal	10 Letters figurative understand	
5 Letters fowls				

July 14–20

Doctrine and Covenants 77–80

“I Will Lead You Along”

Cryptogram

Instructions: Each letter on the top stands for a letter in the alphabet. Solve the encrypted phrase by matching each letter on top to a letter in the alphabet on the bottom. Use the key to help you remember what the letters stand for so you can crack the code.

B	U	F	Z	J	K	G	I	S	N	C	W	Q	M	L	D	A	P	H	O	R	E	Y	X	T	V
A	B	C	D	E	F	G	H	I	J	K	L	M	N	O	P	Q	R	S	T	U	V	W	X	Y	Z

C T U H C W V Q U V J T Y V M B Q O H J

V Q U Y S O W Y S H J G I W V K Q J J T Y A V

V M B Q O H J T A Y Q H J H J G S V Q Z V J O W

Y S H J G I ; P T K Y U H J V Q J P

K T Z V J Q J Y I 7 8 : 6

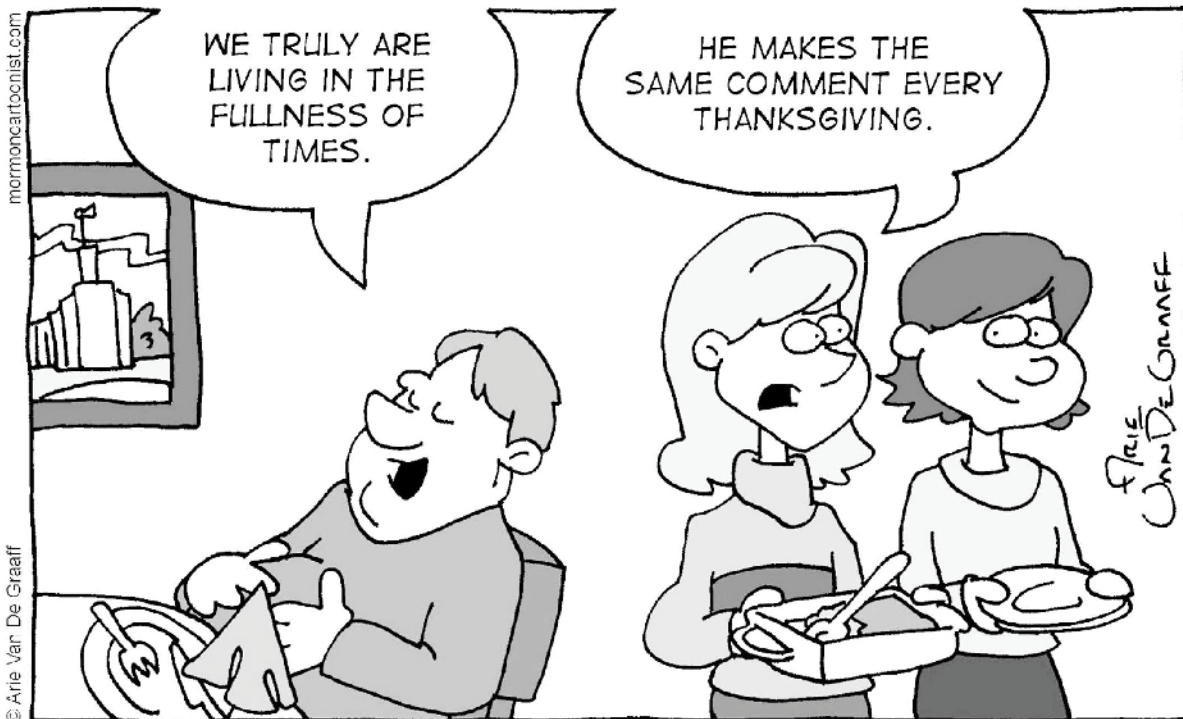

Sharing What You Have

Practice sharing what you have with others by guiding this cold and hungry child through the maze to blankets and food.

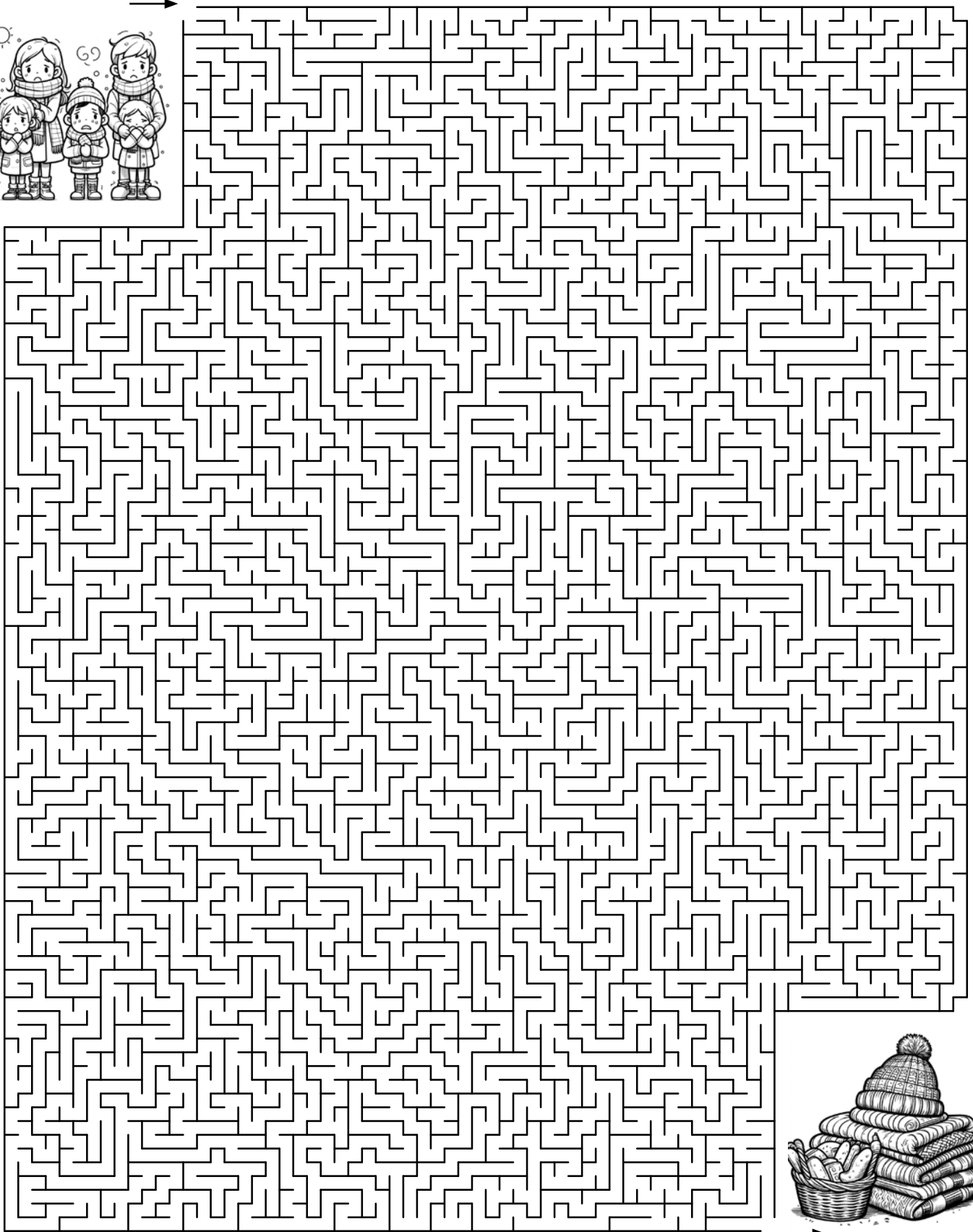

July 14–20

Doctrine and Covenants 77–80

“I Will Lead You Along”

Word Sudoku

Instructions: Solve this word sudoku puzzle the same way that you’d solve a numeric sudoku. Each of the bold words in the scripture below is found once in every row, column and 3×3 box.

Doctrine and Covenants 78:18

And ye cannot bear all things now; nevertheless, be of **good cheer**, for I will **lead you along**. The **kingdom** is **yours** and the blessings thereof are yours, and the **riches** of **eternity** are yours.

cheer						good	riches	
					along	kingdom	eternity	yours
riches	kingdom		good					along
lead			yours			riches	along	
	you				riches	eternity	good	
				eternity		lead	yours	cheer
good		riches	along		you			
kingdom		you	riches				lead	
				good	lead	along	you	

July 21–27

Doctrine and Covenants 81–83

Where “Much Is Given Much Is Required”

Reverse Word Search

Instructions: Instead of looking for words in a grid, place the bold words in the scripture in the empty word search puzzle. The words may be forwards, backwards, up, down, or diagonally. The start letter of the words have been placed in the grid to get you started.

Doctrine and Covenants 82:8–10

And again, I say unto you, I **give** unto you a new **commandment**, that you may **understand** my **will concerning** you; Or, in other **words**, I give unto you **directions how** you may **act before me**, that it may **turn** to you for your **salvation**. I, the **Lord**, am **bound** when ye do what I **say**; but when ye do **not** what I say, ye have no **promise**.

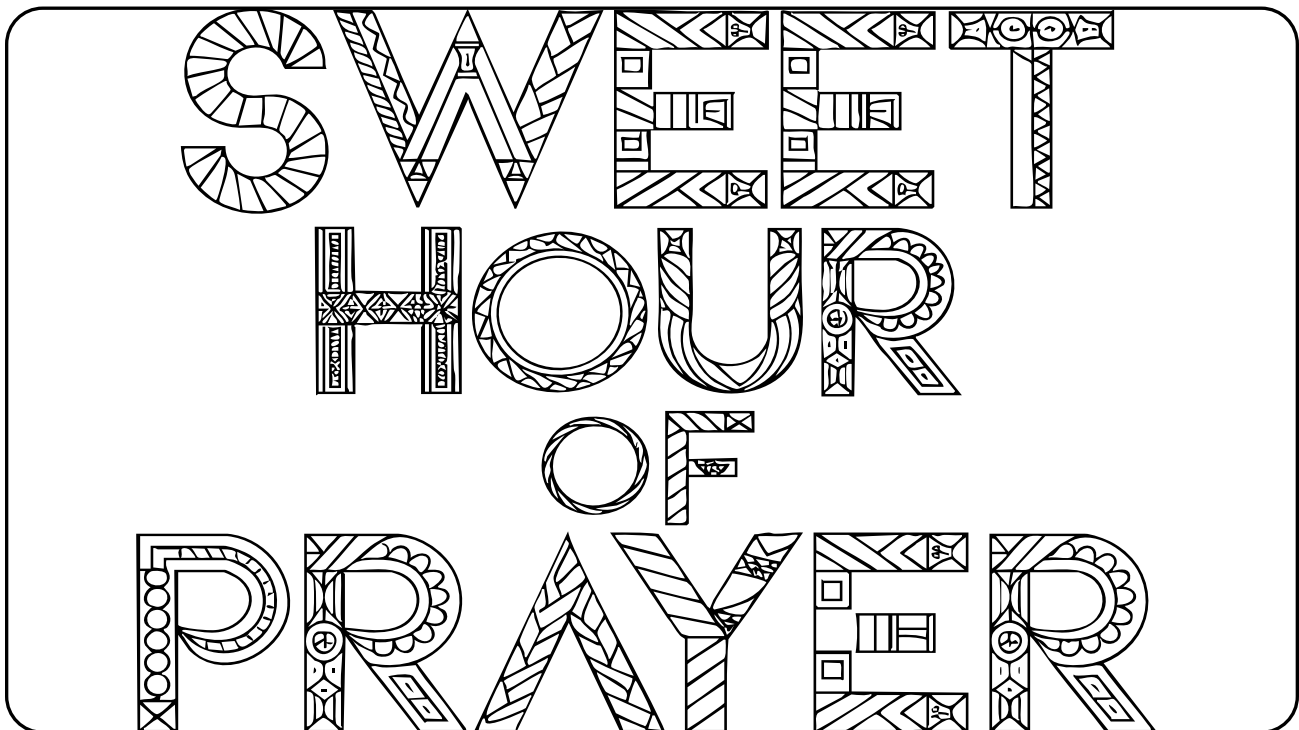
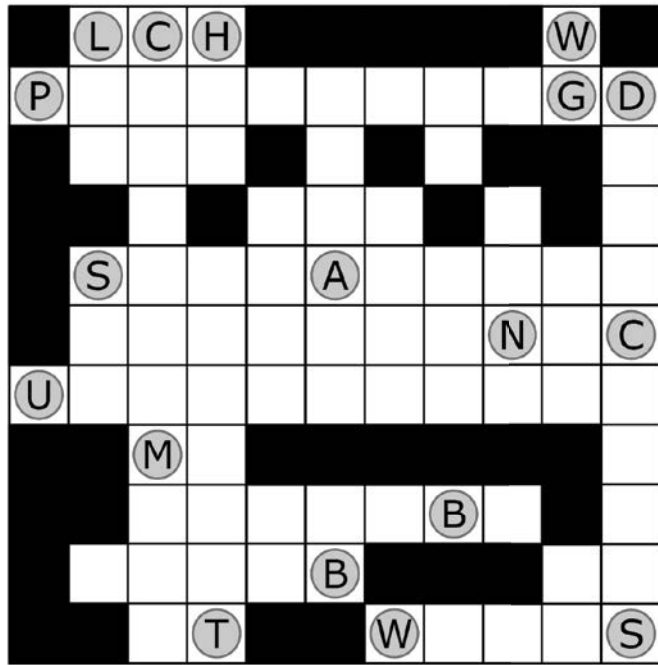

July 21–27

Doctrine and Covenants 81–83

Where “Much Is Given Much Is Required”

Missing Vowels Word Search

Instructions: Find the hidden words. The words have been placed horizontally, vertically, diagonally, forwards, or backwards, and the vowels have been removed. When you locate a word, draw an ellipse around it and fill the vowels in.

Exodus 20:8-11

Remember the **sabbath day**, to **keep** it **holy**. **Six** days shalt thou **labour**, and do all thy **work**: But the **seventh** day is the sabbath of the Lord thy God: in it thou shalt not do any work, thou, nor thy **son**, nor thy **daughter**, thy **manservant**, nor thy **maidservant**, nor thy **cattle**, nor thy **stranger** that is within thy **gates**: For in six days the Lord made **heaven** and **earth**, the **sea**, and all that in them is, and **rested** the seventh day: wherefore the Lord **blessed** the sabbath day, and **hallowed** it.



Unscrambler

Instructions: Unscramble the words below; look at the bold words in the scripture for a hint.

Doctrine and Covenants 81:3

Therefore, verily I **acknowledge** him and will **bless** him, and also thee, inasmuch as thou art **faithful** in **counsel**, in the **office** which I have appointed unto you, in **prayer always, vocally** and in thy **heart**, in **public** and in **private**, also in thy **ministry** in proclaiming the gospel in the land of the living, and among thy brethren.

tnyrmiis _____

laecwndkego _____

slbes _____

affhliut _____

fcfoie _____

aocyvll _____

erpayr _____

vetpira _____

ywalsa _____

olucsne _____

tahre _____

bciulp _____

Mystery Picture Graph

Instructions: Find the mystery picture below by plotting and connecting the points of each line on the coordinate graph. Connect all the points in Line 1, stop, pick up your pencil, and then connect all the points in Line 2, and so on for the rest of the lines. The dot for the first (X,Y) coordinate pair on Line 1 has been placed for you.

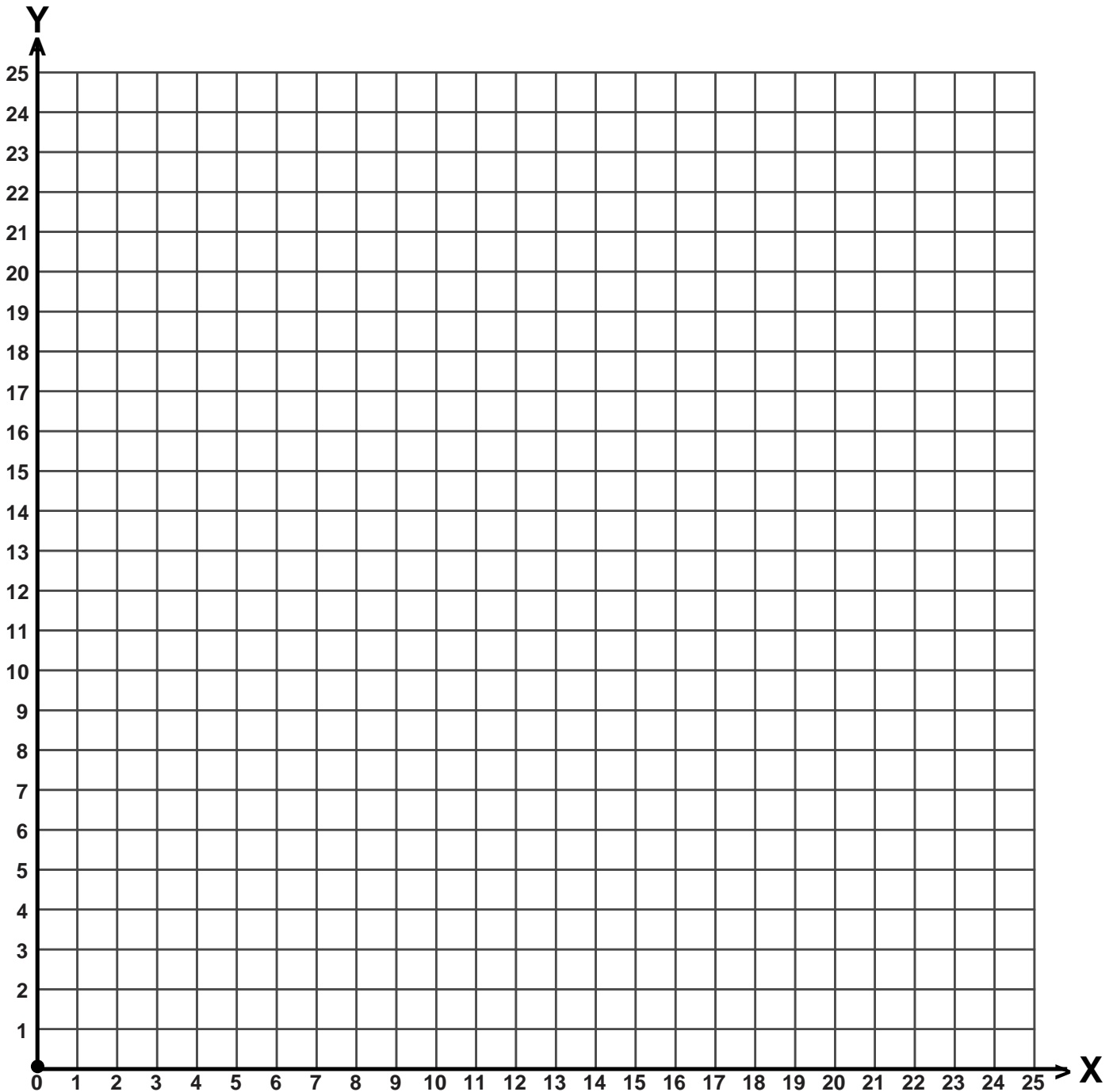

Line 1	(0, 0)	(3, 3)	(3, 4)	(4, 5)	(3, 6)	(4, 11)	(3, 15)	(1, 15)	(3, 17)	(3, 21)	(4, 22)	(5, 22)
(6, 23)	(8, 24)	(10, 23)	(11, 22)	(11, 21)	(9, 17)	(7, 18)	(7, 17)	(9, 16)	(10, 15)	(11, 13)	(11, 12)	(12, 10)
(11, 9)	(8, 11)	(7, 10)	(5, 14)	(5, 15)	(6, 16)	(10, 12)	Line 2	(4, 22)	(5, 21)	(5, 19)	(6, 19)	(6, 21)
(11, 21)	Line 3	(6, 10)	(9, 8)	Line 4	(9, 13)	(9, 15)	(8, 17)	Line 5	(10, 10)	(10, 8)	(17, 3)	(16, 1)
(14, 0)	(11, 0)	(7, 1)	(4, 1)	(1, 0)	Line 6	(13, 2)	(4, 5)	Line 7	(3, 4)	(5, 2)	Line 8	(4, 1)
(8, 3)	Line 9	(3, 15)	(5, 19)	(5, 18)	(8, 16)							

July 21–27

Doctrine and Covenants 81–83

Where “Much Is Given Much Is Required”

Word Square

Instructions: Word squares are a liike Sudoku puzzles, but each letter can occur only once in each row and in each column. Check your puzzle against the answer key on ColorMeChristian.org. Every row and column must contain every letter in the word **NEIGHBOR**. This word can be written in the gray row.

Matthew 22:37–39

And the inhabitants of Zion shall also observe the Sabbath day to keep it holy. And the inhabitants of Zion also shall remember their labors, inasmuch as they are appointed to labor, in all faithfulness; for the **idler** shall be had in remembrance before the Lord.

	R				G	N	H
H	B	E	N	I	O		G
G	I						O
		G	B			I	E
I	O		H	E			
		N	O	G			B
			E	O	N		I

Translation Station

Instructions: Translate the sign language letters below into English to discover the hidden message. Write the alphabet letter beneath each hand sign. Use the key at the back of the book to help you.

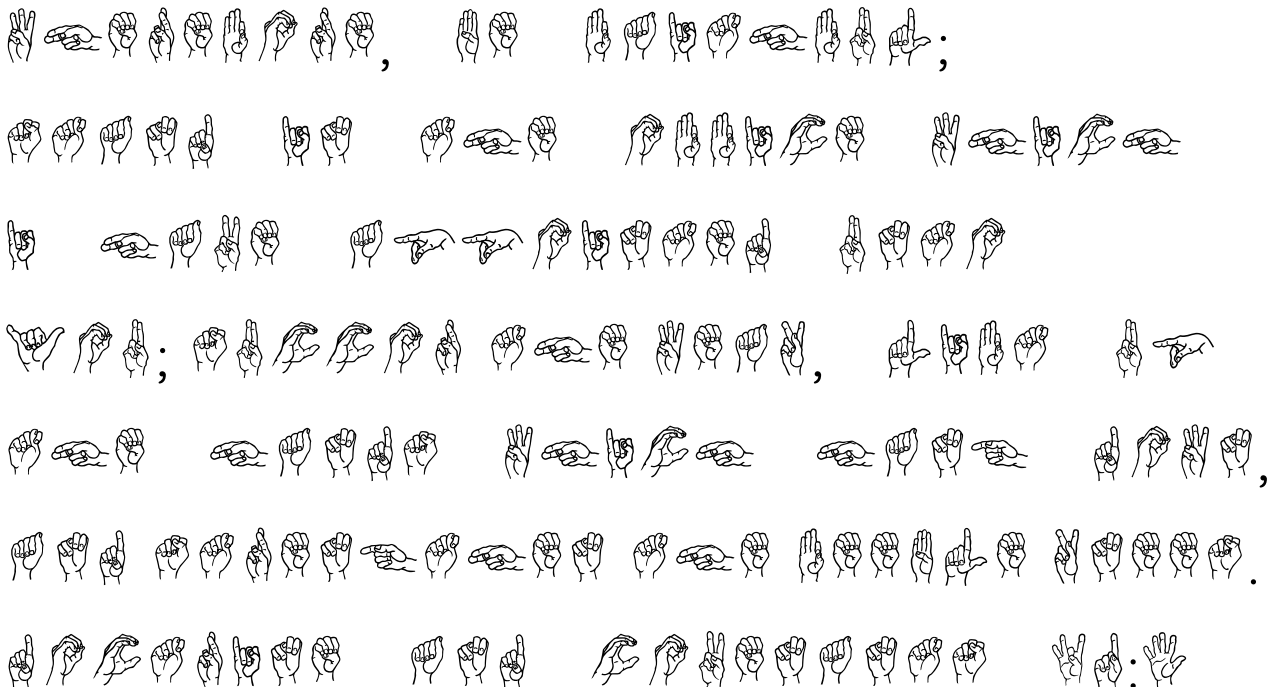

July 21–27

Doctrine and Covenants 81–83

Where “Much Is Given Much Is Required”

Instructions: Connect all of the letters in the maze and then write the phrase in the blanks below. Don't be tricked by letters that take you into a dead end! There is only one path through the maze.

---, ---, ---, ---, ---;
---, ---,
---.

Doctrine and Covenants 82:10

Start

T	H	O	R	D	A	N	U	N	D	W	M	P	S	I	S	E	I	O	R
I	T	L	O	R	D	A	O	U	N	D	O	O	I	M	I	S	E	L	O
T	H	E	L	O	R	D	B	O	U	P	R	N	O	O	M	I	S	E	L
H	E	L	O	R	D	A	M	U	P	O	N	E	N	R	O	I	T	H	E
E	L	O	U	D	A	M	B	O	E	H	E	V	O	P	M	E	I	E	H
L	O	R	O	U	M	E	H	E	Y	E	H	A	V	O	I	S	E	I	T
O	R	M	B	O	E	Y	E	Y	Y	Y	E	H	E	N	M	I	S	E	I
R	D	A	A	S	Y	Y	A	Y	A	Y	Y	A	V	E	O	M	I	S	E
D	A	M	H	I	T	A	S	I	S	Y	E	H	A	N	R	O	M	I	S
A	M	N	W	T	A	H	I	T	A	Y	Y	E	H	A	P	R	O	M	I
M	D	O	N	O	T	W	H	A	Y	Y	E	H	O	N	O	P	R	O	S
B	E	Y	N	E	H	W	T	U	Y	E	H	A	V	E	N	O	P	R	I
O	U	N	Y	E	E	H	E	B	E	H	A	P	E	N	O	P	R	O	M
U	N	D	W	D	O	E	N	Y	H	A	V	O	P	R	O	M	I	S	E
N	D	W	N	O	D	E	Y	A	A	V	E	N	O	P	R	O	M	I	R
D	W	H	E	U	B	Y	A	S	V	E	N	M	I	S	E	I	E	L	O
W	H	D	O	W	U	B	S	I	E	N	R	O	M	I	S	T	H	E	L
H	Y	E	D	O	I	T	A	T	N	O	P	R	O	M	I	I	T	H	E
E	N	Y	E	D	O	W	H	A	O	P	R	O	M	I	S	E	I	T	H

Finish

July 21–27

Doctrine and Covenants 81–83

Where “Much Is Given Much Is Required”

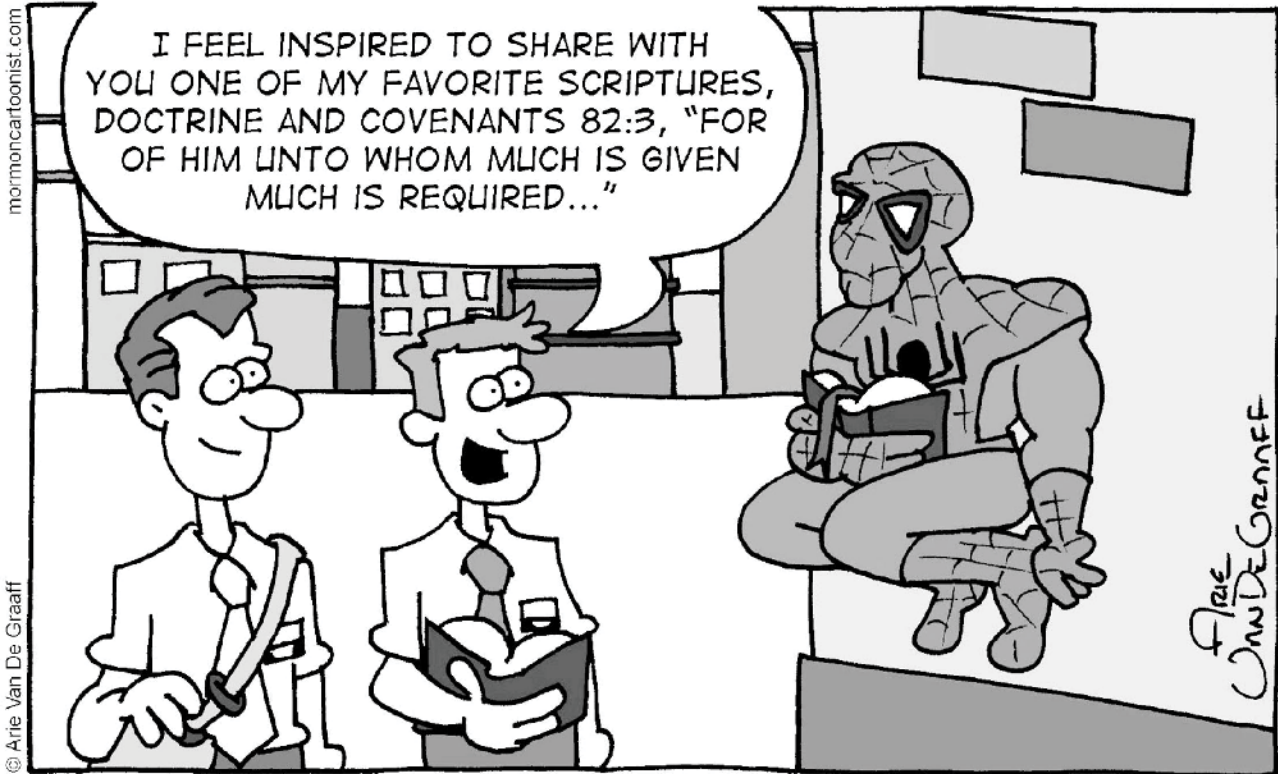

Handwriting Practice

Practice your handwriting by tracing the sentence below. Then use the blank lines to write the sentence on your own.

Heavenly Father promises
blessings as I strive to obey
Him.

July 28–August 3

Doctrine and Covenants 84

“The Power of Godliness”

Word Guess

Instructions: Write your word guesses in the puzzle below. For extra hints, look at the words/phrases in the scripture below. Check the answer on ColorMeChristian.org

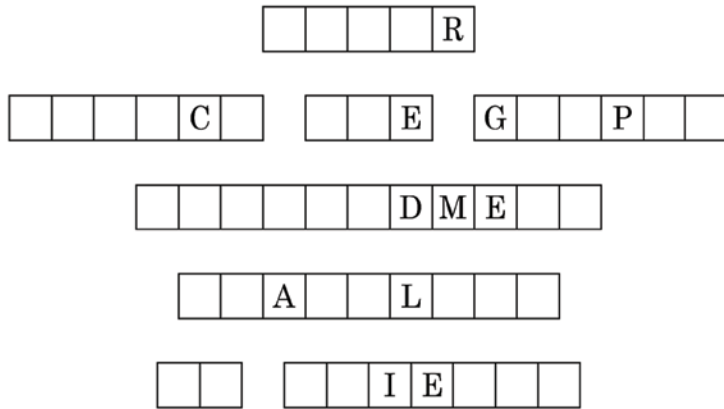

Doctrine and Covenants 84:77

And again I say unto you, my friends, for from henceforth I shall call you friends, it is expedient that I give unto you this commandment, that ye become even as my friends in days when I was with them, traveling to preach the gospel in my power;

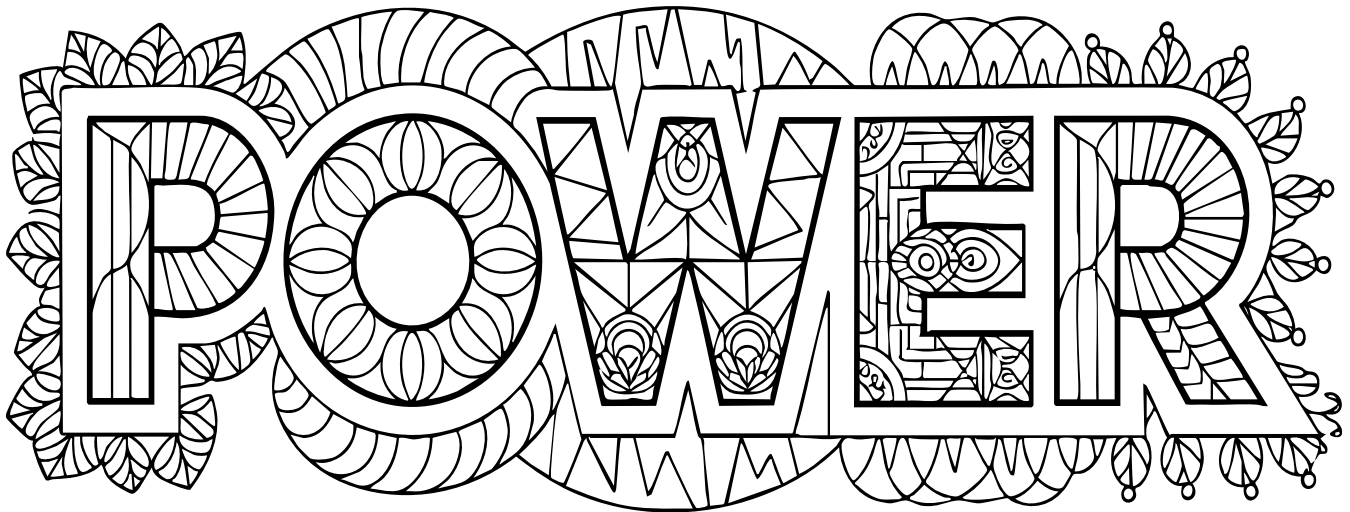

Therefore, in the ordinances thereof,
the power of godliness is manifest.

Doctrine and Covenants 84:20

July 28–August 3

Doctrine and Covenants 84

“The Power of Godliness”

Wacky Word Trails

Instructions: Start with the circled letter, use the clues to find and mark the trail of letters of all the connected bolded words from the scripture through the maze to the last letter. The path can wander up, down, left, and right at any point, even in the middle of the word.

Doctrine and Covenants 84:4–5

Verily this is the **word** of the Lord, that the **city New Jerusalem** shall be **built** by the **gathering** of the **saints**, **beginning** at this **place**, even the place of the **temple**, which temple shall be **reared** in this **generation**. For verily this generation shall not all **pass away** until an **house** shall be built unto the **Lord**, and a **cloud** shall **rest** upon it, which cloud shall be even the **glory** of the Lord, which shall **fill** the house.

E S **(T)** E M P J K R E S T F I J
P U O H E L Y D E C Q C L L C
A S E B V O N P L A O L B K S
N S I L C P O H S D U G W Q Z
E Y T Y S L I T E P B V W R D
W O X T G E R A Q Z M A S S J
R Q A N M N E F M Y F W J R O
E A N T E L A S K A J L G D L
S R J S W E R U A Y R O F N Y
F E D G N J Y A W B E X E V T
Q T T A T W Y G O C X F A I I
G S R V H E Z G B M D K S N C
D X J Y Q R I N U I L N G T D
T D N F E D Y I E B T I I S R
H C P D P R V D G I N N L W O

Knight Moves - Find a Word

Instructions: Start with any letter in the puzzle to see if it's the beginning of a word. To get to the second letter, jump two squares in any direction except diagonally, and then one square in a different direction. Your path will look like a capital L. Only one route through the puzzle will make a word. Write the letters of the word you discover in the blanks below as you jump through the squares:

1 2 3 4 5 6 7 8

Now can you find this word in the following scripture?

Doctrine and Covenants 84:20

s	a	f
i		t
m	e	n

Hidden Picture: Temple ordinances help us prepare to live with Heavenly Father again. Can you find 5 pictures of the temple in the hidden picture below? It will be tricky; the pictures may be smaller, on their side, or even upside down! Then, see if you can find one copy of the animals as well.

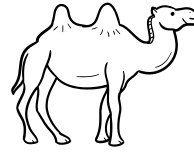
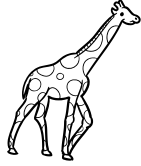

July 28–August 3

Doctrine and Covenants 84

“The Power of Godliness”

Letter Sudoku

Instructions: Solve the letter sudoku puzzle the same way you’d solve a numeric sudoku. Check your puzzle against the answer key on ColorMeChristian.org. Every column, row, and group of nine must contain every letter in the word(s) **MANIFEST**.

Doctrine and Covenants 84:20-21

Therefore, in the ordinances thereof, the power of godliness is **manifest**. And without the ordinances thereof, and the authority of the priesthood, the power of godliness is not manifest unto men in the flesh;

	F	A					
N					E		
						S	
					M		A
			E		S		T
	T				I		N
		M				F	
	I	F	S			E	



July 28–August 3

Doctrine and Covenants 84

“The Power of Godliness”

Instructions: Using the Across and Down clues, write the correct words in the numbered grid below. Hint: all of the words in the crossword come from the scripture below.

Doctrine and Covenants 84:18–25

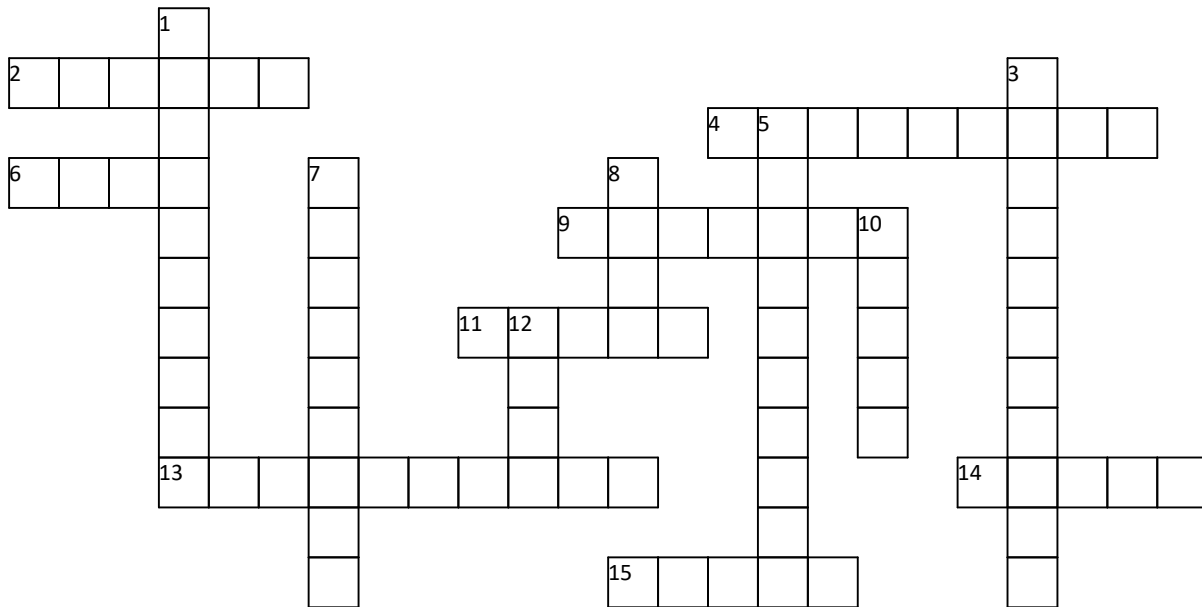

ACROSS

2. the hollow muscular organ located behind the sternum
4. the state of being like God, divine qualities
6. the front of the human head from the forehead to the chin
9. the domain ruled by a monarch
11. a group of people living according to divine commandments from God
13. in a hard-working manner
14. the ability to do something or act in a particular way
15. in the middle of something

DOWN

1. The authority and power that God gives to man to act in all things for the salvation of man
3. a body of living beings constituting a single step in the line of descent from an ancestor
5. an authoritative rule
7. the power or right to give orders or make decisions
8. have life, be alive"
10. an Old Testament prophet who led the Israelites out of Egyptian bondage and gave to them a set of religious, social, and dietary laws as revealed by God
12. take a short break from one's activities in order to relax

August 4–10

Doctrine and Covenants 85–87

“Stand Ye in Holy Places”

Word Angles

Instructions: Find the bold words from the scripture. Each word path may run north, east, south, or west, may make one right-angled turn, and may cross another word path. A few words may make no right angle turn at all.

Doctrine and Covenants 86:5–7

Behold, verily I say unto you, the **angels** are **crying** unto the Lord day and night, who are **ready** and waiting to be sent forth to **reap** down the **fields**; But the Lord saith unto them, **pluck** not up the **tares** while the **blade** is yet **tender** (for verily your **faith** is **weak**), lest you **destroy** the **wheat** also. Therefore, let the wheat and the tares **grow** together until the **harvest** is fully **ripe**; then ye shall **first gather** out the wheat from **among** the tares, and **after** the gathering of the wheat, behold and lo, the tares are **bound** in **bundles**, and the **field** remaineth to be **burned**.

C Y E W G M R R L A K D Z A B O
A A B G G Z E E Y D A E R M U R
R C R Y I N D N E T B A C R R D
K Q Z Q U G J N Q S E R K H N L
E W O J Z Y O A R E A A Z D E E
F Y R V A A R A D D P T C Z Q I
Y N G Q H M T U N G J S L E Z F
B K K N F R S A U O B J Q G G T
B O N G X H E S R E T F A N A Z
D M M M B T D D L E I F S A T G
Z A C R L I A F G O A Z W V H X
A K J T A D E X N Y Z A R Z E R
E P T S V T A E H L P S I I Z R
W N S E U C K I W X T E P Y K D
H A R V L V U O G G I L E U V J
N F I J P W C Z T G D D N U B X

Fill in the Blank

Doctrine and Covenants 86:2-3

Behold, verily I say, the _____ was the _____, and the _____ were the _____ of the _____; And after they have fallen _____ the great _____ of the church, the _____, the whore, even _____, that maketh all _____ to _____ of her _____, in whose hearts the _____, even _____, sitteth to reign-behold he _____ the _____; wherefore, the tares _____ the wheat and drive the church into the _____.

cup	asleep	apostate	sowers	persecutor	apostles
nations	field	choke	Satan	tares	drink
soweth	seed	wilderness	enemy	world	Babylon

.8

.7 .9
.6 .5 11 . .10

.3 .4 .16 .12 .13

.2 .19 .15 .14
17 .1 18 .41 .33
.23 .24 .37 .36
.22 .20

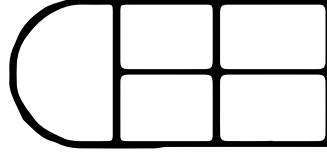

.28 .29 .31 .35 .34
.27 .30
21 25 26 .40
.20

August 4–10

Doctrine and Covenants 85–87

“Stand Ye in Holy Places”

Handwriting Practice

Practice your handwriting by tracing the sentence below. Then use the blank lines to write the sentence on your own.

I can stand in holy places.

I can stand in holy places.

Letterbox Puzzle

Instructions: Find the hidden word in the puzzle below by crossing out all letters that occur twice or more. Capitalized and lowercase letters count as unique letters for this puzzle. The letters left over will form a word. Write down the left over letters like you would read a book, from left to right and top to bottom. Then find the hidden word in the scripture or phrase below and circle it.

Doctrine and Covenants 87:6

And thus, with the sword and by bloodshed the inhabitants of the earth shall mourn; and with famine, and plague, and earthquake, and the thunder of heaven, and the fierce and vivid lightning also, shall the inhabitants of the earth be made to feel the wrath, and indignation, and chastening hand of an Almighty God, until the consumption decreed hath made a full end of all nations

Write the hidden word:

i	g	i	c	t	f
K	H	T	u	f	F
g	A	n	G	W	d
b	D	f	F	c	v
e	W	b	T	v	r
A	r	D	K	R	G

August 4–10

Doctrine and Covenants 85–87

“Stand Ye in Holy Places”

Word Spiral

Instructions: Fill in the blank puzzle grid using the bold words from the scripture or phrase below. *The bold words may not all be used!* Use the letter hint below and count the letters of the bold words to figure out where each word goes. Then transfer the letters that have little numbers in their box to the hidden word at the bottom of the puzzle. Check the answer on ColorMeChristian.org.

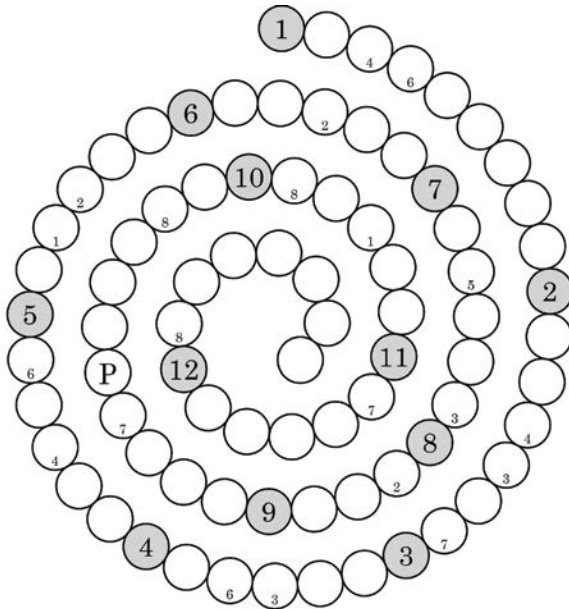

Doctrine and Covenants 85:6

Yea, thus saith the **still small voice**, which **whispereth through** and **pierceth all things**, and **often times** it maketh my **bones** to **quake** while it maketh **manifest**, saying

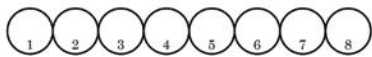

Stand ye in holy places and be not moved. (Doctrine and Covenants 87:8)

August 4–10

Doctrine and Covenants 85–87

“Stand Ye in Holy Places”

God’s “great work” is built on “small things.”

Come, Follow Me 2025 Manual

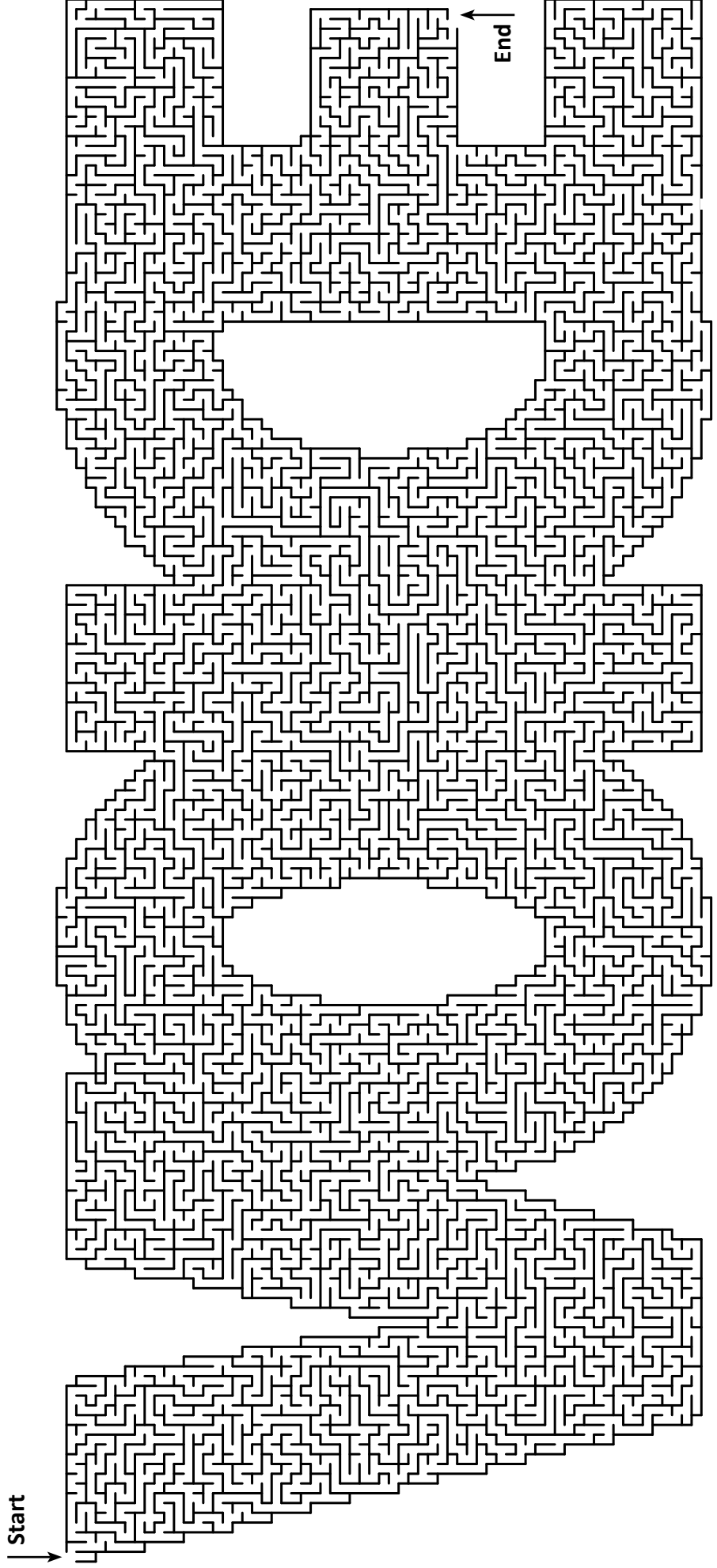

August 4–10

Doctrine and Covenants 85–87

“Stand Ye in Holy Places”



Secret Code

Instructions: The secret message is written in symbols. In the code key you can find what each symbol means. Write the letter above the symbol and you can read the secret message.

a	b	c	d	e	f	g	h	i	j	k	l	m
□	◇	△	▱	⬡	▷	▽	⊗	◀	▾	▵	▶	▴
n	o	p	q	r	s	t	u	v	w	x	y	z
◁	▱	▽	▱	○	▱	⋈	⊗	⊗	▾	◀	▴	⊗

▱⊗○⊗▷▱⊗' ⊗▷⊗▱▱⊗▱ ⊗⊗ ⊗⊗ ⊗⊗ ⊗⊗
 ▱▱▷▱⊗⊗⊗⊗ ⊗⊗ ▱⊗ ▱▱▱▱⊗⊗⊗⊗'
 ⊗ ▷⊗⊗⊗ ⊗⊗⊗ ▱⊗⊗ ▱⊗⊗ ▱⊗⊗⊗⊗⊗⊗' ⊗⊗⊗
 ▱⊗⊗⊗⊗⊗ ▱⊗⊗⊗ ▱⊗⊗⊗⊗⊗⊗⊗⊗'
 ⊗ ▱⊗⊗⊗⊗⊗ ⊗⊗⊗⊗ ▱⊗
 ▱⊗⊗⊗⊗⊗ ⊗⊗⊗⊗⊗⊗' ▱⊗⊗ ▷⊗⊗⊗ ⊗⊗⊗⊗
 ▱⊗⊗⊗ ⊗⊗' ⊗⊗⊗⊗' ▱▱▷⊗⊗⊗⊗⊗⊗ ⊗⊗⊗
 ▱▱⊗⊗⊗⊗⊗⊗⊗

8 6 : 1 1

August 11–17

Doctrine and Covenants 88

“Establish ... a House of God”



Organize yourselves; prepare every needful thing; and establish a house, even a house of prayer, a house of fasting, a house of faith, a house of learning, a house of glory, a house of order, a house of God;

Doctrine and Covenants 88:119

August 11–17

Doctrine and Covenants 88

“Establish ... a House of God”

Word Search

Instructions: Find the bold words from the scripture in the word search puzzle. Each word could be hidden forwards, backwards, up, down, or diagonally.

Doctrine and Covenants 88:63

Draw near unto me and I **will** draw near unto **you**; **seek** me **diligently** and ye **shall find** me; **ask**, and ye shall **receive**; **knock**, and it shall be **opened** unto you.

O	P	L	Q	M	Y	E	G	R	P	Y	N	A	H	U
U	X	W	L	E	W	W	P	W	P	L	Z	K	M	J
O	N	S	Q	I	K	U	N	T	O	B	G	H	S	U
Y	V	Z	K	C	W	Z	K	R	D	K	P	P	J	A
X	M	A	O	N	D	E	J	T	N	N	Y	M	W	S
L	D	N	Y	D	E	R	Z	O	Q	L	I	O	A	N
O	K	R	F	S	G	L	U	M	T	W	M	F	M	L
P	G	Z	M	R	Y	Y	Z	N	F	E	Y	D	L	O
E	J	P	I	S	B	G	E	D	R	A	W	A	R	I
N	R	V	Y	B	I	G	J	V	U	H	H	R	E	O
E	G	Q	A	R	I	K	L	M	Q	S	G	F	C	S
D	A	I	A	L	M	P	X	Z	H	Q	X	T	E	T
G	O	E	I	U	Q	H	X	E	I	D	E	S	I	O
Q	N	D	R	M	O	Z	E	W	B	U	B	P	V	R
M	M	L	K	K	N	E	J	X	U	A	C	F	E	T

Word Star

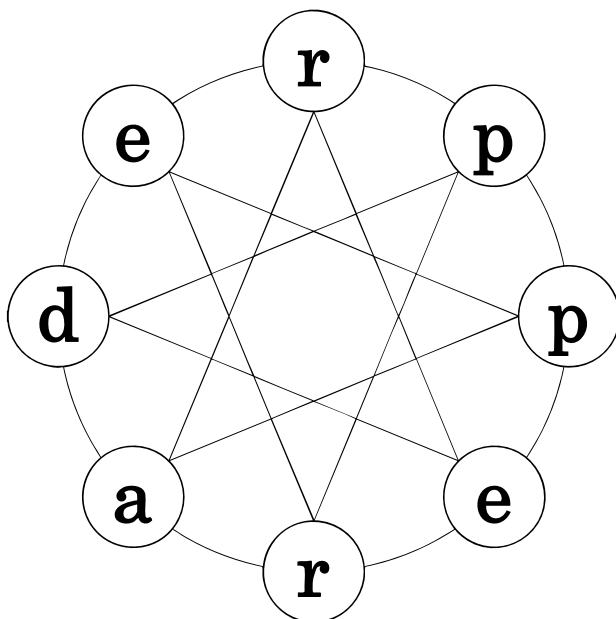

Instructions: Only one route through the word star will make a word. Try each letter and follow the pathway through the star to see if it makes a word.. IF you need a hint, look at the words in the scripture below. Write the letters of the word you discover in the blanks below as you travel through the star:

Now can you find this word in the following scripture?

Doctrine and Covenants 88:80

August 11–17

Doctrine and Covenants 88

“Establish ... a House of God”

Instructions: Fit the bold words from the scripture below into the encircled squares. Words will read forward, backward, up, down, and diagonally and will normally cross other words. Start with the hints provided.

Doctrine and Covenants 88:78–79

Teach ye diligently and my **grace** shall **attend** you, that you may be **instructed** more **perfectly** in **theory**, in **principle**, in **doctrine**, in the **law** of the **gospel**, in all things that **pertain** unto the **kingdom** of **God**, that are expedient for you to understand; Of things both in **heaven** and in the **earth**, and under the earth; things which have **been**, things which are, things which must shortly **come** to pass; things which are at **home**, things which are **abroad**; the **wars** and the **perplexities** of the **nations**, and the **judgments** which are on the **land**; and a **knowledge** also of **countries** and of kingdoms—

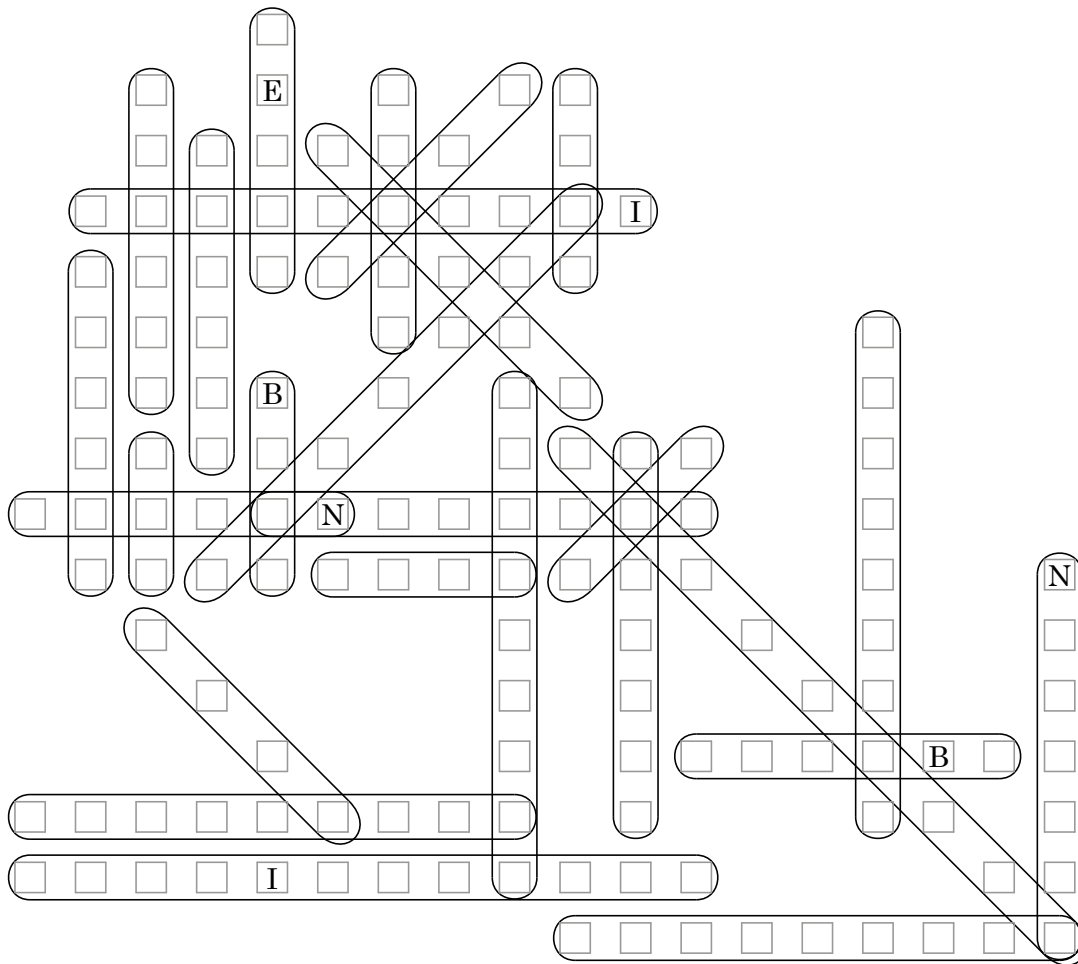

Teach	grace	attend	instructed	perfectly	theory
principle	doctrine	law	gospel	pertain	kingdom
God	heaven	earth	been	come	home
abroad	wars	perplexities	nations	judgments	land
knowledge	countries				

August 11-17

Doctrine and Covenants 88

“Establish ... a House of God”

Cryptogram

Instructions: Each letter on the top stands for a letter in the alphabet. Solve the encrypted phrase by matching each letter on top to a letter in the alphabet on the bottom. Use the key to help you remember what the letters stand for so you can crack the code.

I	U	G	Z	E	B	Y	Q	P	F	K	J	W	X	N	S	L	D	H	M	V	R	O	A	C	T
A	B	C	D	E	F	G	H	I	J	K	L	M	N	O	P	Q	R	S	T	U	V	W	X	Y	Z

R̄ V̄ X̄ M̄ Ō Ē X̄ V̄ B̄ Ō Z̄ W̄ T̄ Ē X̄ Ō R̄ Ā M̄ Ā Q̄ Q̄

R̄ V̄ X̄ M̄ Ō Ē X̄ V̄ B̄ Ō Z̄ W̄ Ḡ W̄ B̄ ; P̄ Ē Ē K̄ T̄ Ē

R̄ Ā Q̄ Ā C̄ Ē Ō Z̄ Q̄ Ḡ X̄ Ō R̄ Ḡ Ē P̄ S̄ X̄ Q̄ Q̄ J̄ Ā Ō R̄

T̄ Ē ; X̄ P̄ K̄ , X̄ Ō R̄ Ḡ Ē P̄ S̄ X̄ Q̄ Q̄

V̄ Ē Ȳ Ē Ā Ū Ē ; K̄ Ō W̄ Ȳ K̄ , X̄ Ō R̄ Ā Z̄ P̄ S̄ X̄ Q̄ Q̄

F̄ Ē W̄ Ī Ē Ō Ē R̄ B̄ Ō Z̄ W̄ Ḡ W̄ B̄ . R̄ W̄ Ȳ Z̄ V̄ Ā Ō Ē

X̄ Ō R̄ Ȳ W̄ Ū Ē Ō X̄ Ō Z̄ P̄ 8 8 : 6 3

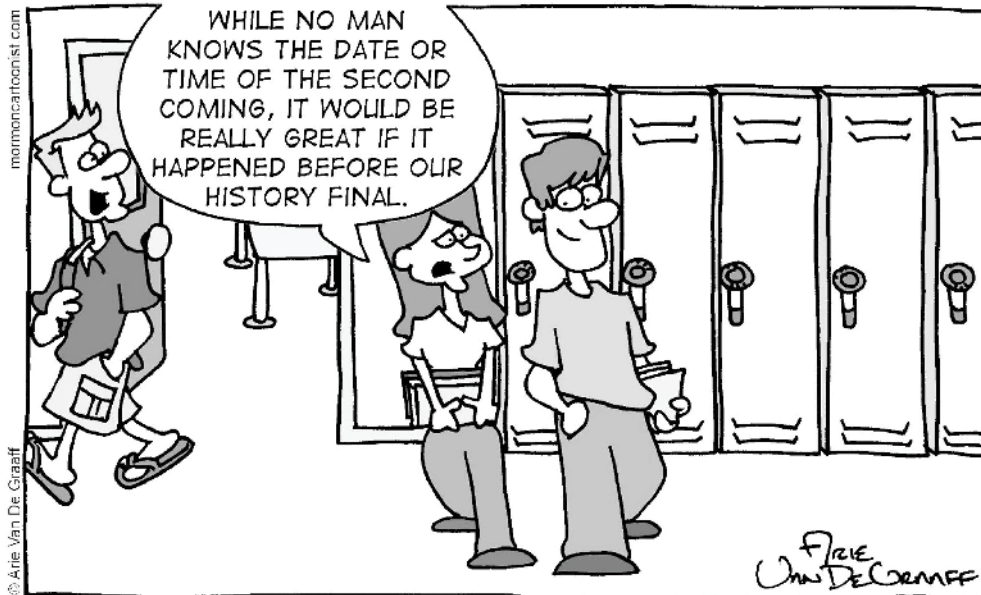

Learning Each Day

Heavenly Father wants us to learn. Help the children on the bus make it through the maze to their school.

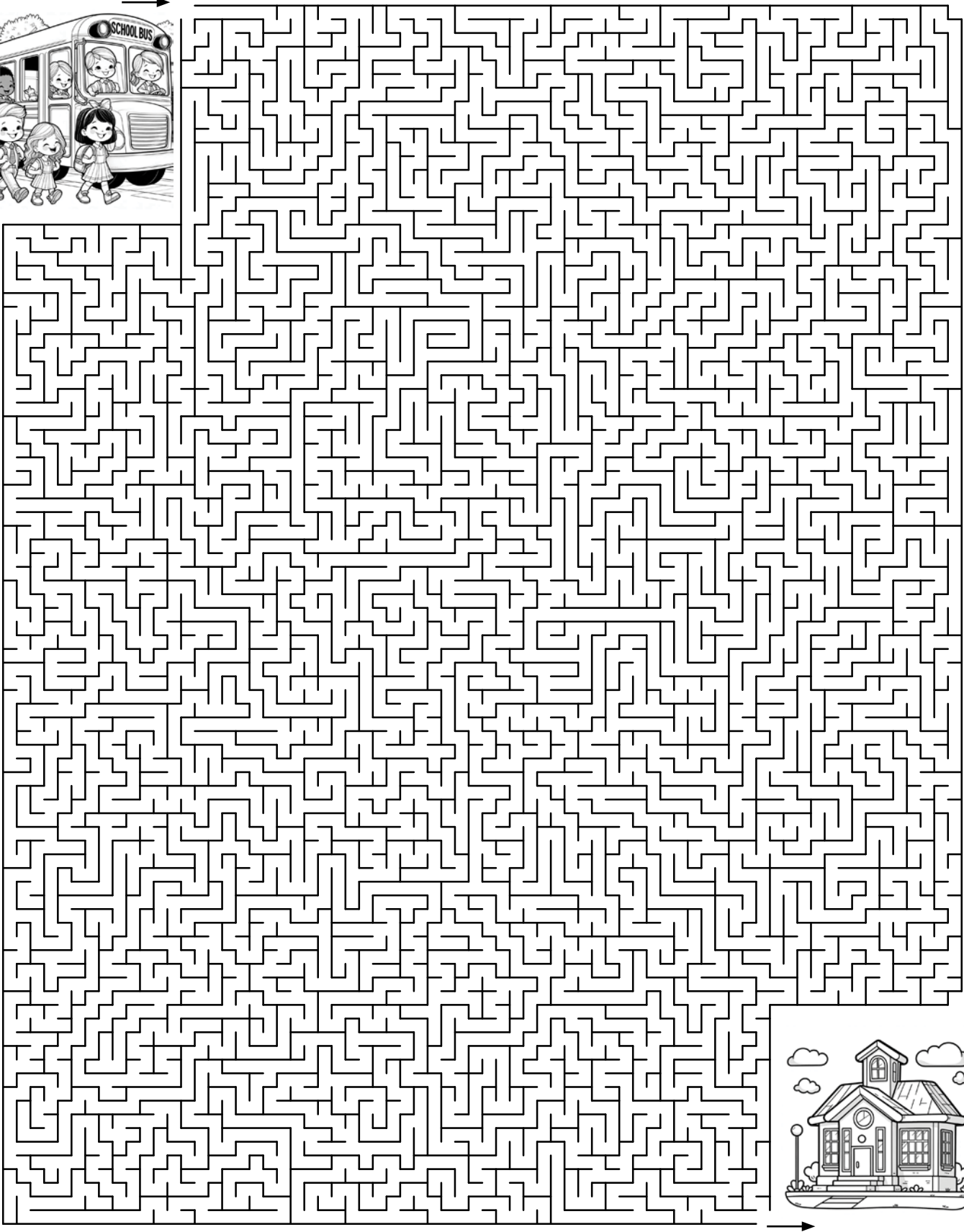

August 11-17

Doctrine and Covenants 88

“Establish ... a House of God”

Word Sudoku

Instructions: Solve this word sudoku puzzle the same way that you'd solve a numeric sudoku. Each of the bold words in the scripture below is found once in every row, column and 3x3 box.

Doctrine and Covenants 88:118

And as all have not **faith**, **seek** ye **diligently** and **teach** one another **words** of **wisdom**; yea, seek ye out of the best **books** words of wisdom; seek **learning**, even by **study** and also by faith.

	diligently	seek				words		
	faith		words		study	learning		
words				learning				diligently
			study	seek	faith	teach		
	teach	diligently					learning	
	words	faith			diligently		seek	
		study		faith		seek		
diligently	seek			books		study		
	books	wisdom	seek					learning

August 18–24

Doctrine and Covenants 89–92

“A Principle with Promise”

Translation Station

Instructions: Translate the sign language letters below into English to discover the hidden message. Write the alphabet letter beneath each hand sign. Use the key at the back of the book to help you.

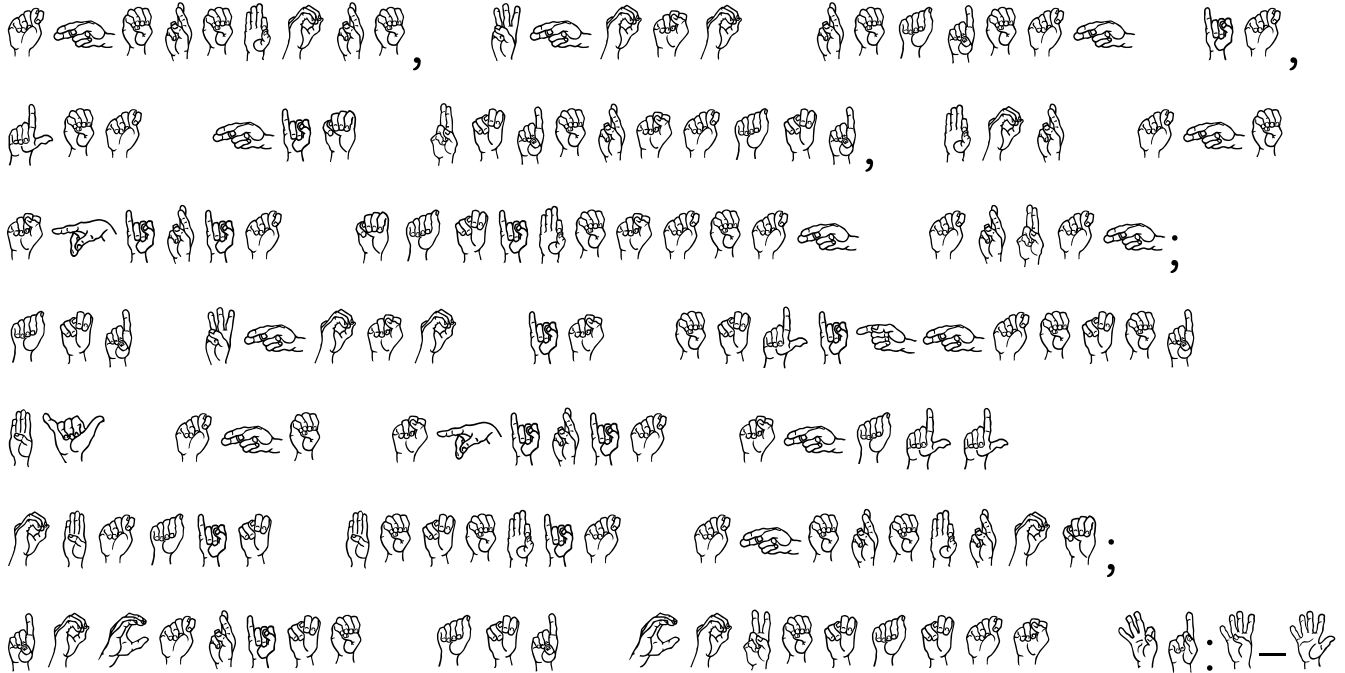

August 18–24

Doctrine and Covenants 89–92

“A Principle with Promise”

Missing Vowels Word Search

Instructions: Find the hidden words. The words have been placed horizontally, vertically, diagonally, forwards, or backwards, and the vowels have been removed. When you locate a word, draw an ellipse around it and fill the vowels in.

Doctrine and Covenants 89:10–11

And again, **verily** I say unto you, all **wholesome** herbs God hath **ordained** for the **constitution**, **nature**, and **use of man**— **Every herb** in the **season thereof**, and every **fruit** in the season thereof; all these to be **used** with **prudence** and **thanksgiving**.



Unscrambler

Instructions: Unscramble the words below; look at the bold words in the scripture for a hint.

Doctrine and Covenants 91:1–2

Verily, thus saith the Lord unto you **concerning** the **Apocrypha**—There are many **things** contained **therein** that are **true**, and it is **mostly translated correctly**; There are many things **contained** therein that are **not** true, which are **interpolations** by the hands of **men**.

myolts _____

uert _____

nitrpoeslanito _____

ton _____

daraentslt _____

ncoringnec _____

enm _____

sghtni _____

yctocrlre _____

ethnrie _____

cnaoniedt _____

rapyhoacp _____

Mystery Picture Graph

Instructions: Find the mystery picture below by plotting and connecting the points of each line on the coordinate graph. Connect all the points in Line 1, stop, pick up your pencil, and then connect all the points in Line 2, and so on for the rest of the lines. The dot for the first (X,Y) coordinate pair on Line 1 has been placed for you.

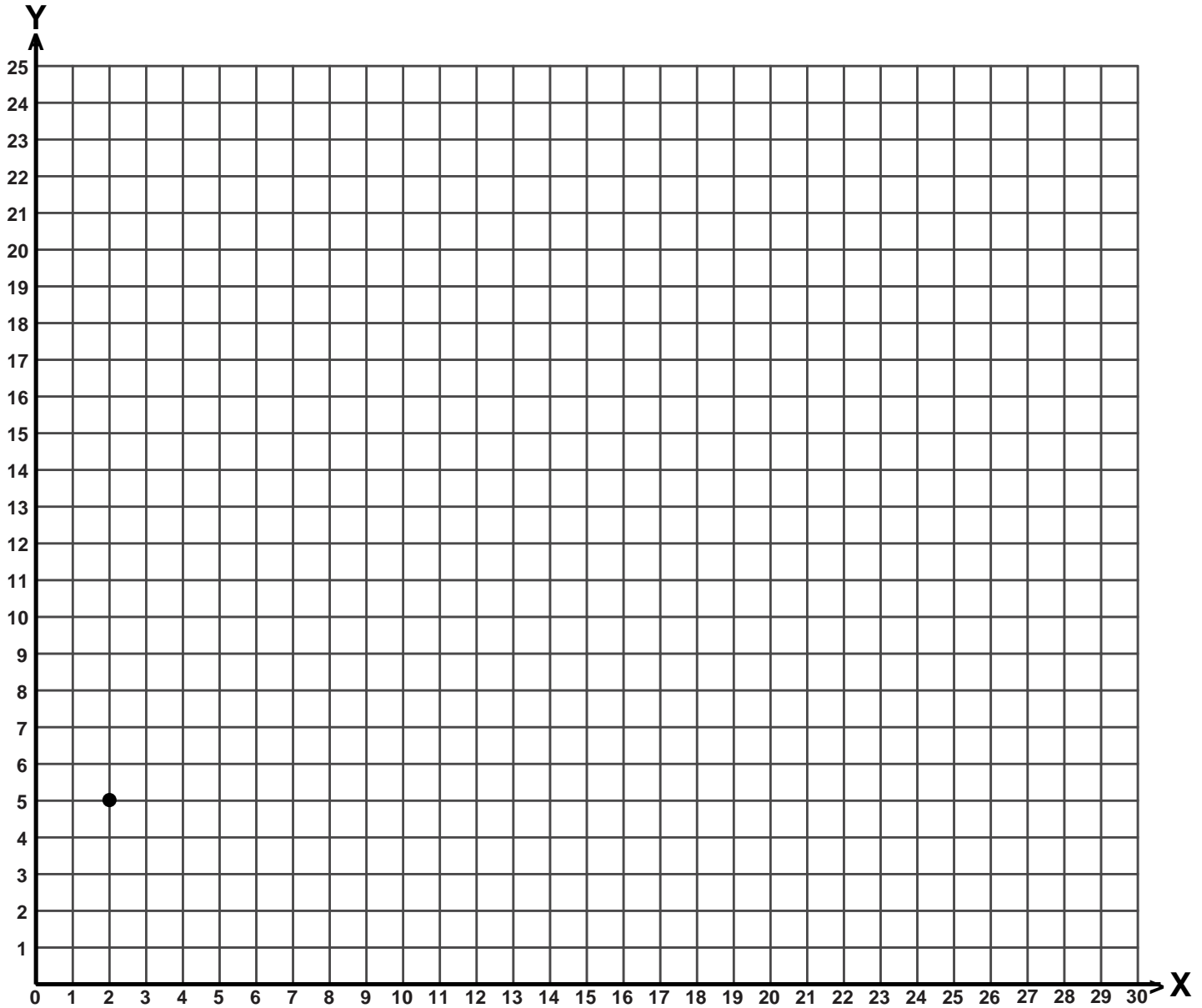

Line 1	(2, 5)	(2, 10)	(0, 11)	(2, 13)	(4, 12)	(5, 13)	(7, 14)	(17, 12)	(14, 12)	(13, 11)	(11, 12)
(9, 10)	(9, 8)	(10, 8)	(10, 3)	(2, 5)	Line 2	(10, 3)	(13, 3)	(17, 6)	(17, 9)	(18, 9)	(18, 11)
(17, 12)	Line 3	(12, 3)	(18, 2)	(19, 1)	(22, 1)	(23, 2)	(24, 4)	(26, 5)	(24, 7)	(22, 7)	(21, 6)
(18, 7)	(17, 6)	Line 4	(12, 3)	(13, 2)	(18, 1)	(19, 0)	(22, 0)	(24, 1)	(25, 3)	(26, 4)	(26, 5)

August 18–24

Doctrine and Covenants 89–92

“A Principle with Promise”



Word Square

Instructions: Word squares are a liike Sudoku puzzles, but each letter can occur only once in each row and in each column. Check your puzzle against the answer key on ColorMeChristian.org. Every row and column must contain every letter in the word **ORACLES**. This word can be written in the gray row.

Doctrine and Covenants 90:5

And all they who receive the **oracles** of God, let them beware how they hold them lest they are accounted as a light thing, and are brought under condemnation thereby, and stumble and fall when the storms descend, and the winds blow, and the rains descend, and beat upon their house.

				S	E	A
		A				S
R		C		O	L	E
	E	O		L		R
O	A	S		E	R	
	O					L
L					A	

Instructions: Connect all of the letters in the maze and then write the phrase in the blanks below. Don't be tricked by letters that take you into a dead end! There is only one path through the maze.

-----, -----, -----: -----

 -----, -----, -----, -----

Doctrine and Covenants 89:4

Finish

Start

H	T	Y	T	I	R	E	V	D	V	E	B	N	O	D	R	O	W	S	I	H	T	U	O	B	S	Y	A	D
T	Y	L	Y	T	H	L	D	L	O	B	N	O	F	W	D	R	O	W	O	I	H	O	Y	U	O	S	I	T
Y	L	I	L	Y	T	O	H	E	H	E	B	I	W	I	O	D	R	O	R	S	O	T	O	B	Y	I	H	S
L	I	R	E	R	Y	L	H	B	N	O	I	T	I	S	D	O	D	R	Y	O	T	N	G	Y	N	H	A	A
I	R	E	V	E	R	I	T	N	O	I	T	A	S	D	O	F	W	D	O	T	N	U	I	G	R	A	V	L
R	E	V	D	V	E	L	Y	B	I	T	A	L	D	B	Y	V	E	O	F	O	T	G	V	I	A	V	E	E
E	H	D	L	E	R	I	L	Y	O	A	L	E	O	M	B	E	V	F	W	N	O	N	I	V	W	E	R	H
B	E	H	O	R	I	L	Y	T	I	T	E	V	E	R	Y	R	E	V	I	R	A	W	E	R	E	W	A	T
E	H	O	L	Y	L	Y	T	H	T	A	L	E	V	E	R	E	V	E	Y	N	R	A	W	O	Y	N	R	N
H	O	L	T	T	Y	T	H	U	I	T	A	L	E	V	E	L	O	Y	N	R	A	F	D	E	N	I		
T	H	T	I	A	T	H	S	S	S	I	T	A	L	E	V	E	L	A	U	O	Y	N	F	D	Y	N	I	N
H	T	I	A	S	H	U	S	S	A	O	I	T	A	L	E	L	A	T	E	R	O	F	D	N	O	U	N	E
T	H	T	I	S	U	S	S	A	B	N	O	I	T	A	L	A	O	I	R	O	F	D	N	A	U	N	E	M
H	T	H	T	S	A	S	A	I	T	B	N	O	I	T	I	T	N	O	E	R	O	D	H	C	H	D	O	G
E	L	T	H	A	I	A	I	V	I	L	B	I	S	E	D	E	S	E	W	E	A	O	C	I	C	O	A	N
L	O	R	T	Y	T	I	T	E	V	E	I	S	E	D	D	E	D	A	D	N	A	I	H	W	D	N	I	
O	R	N	T	O	Y	N	C	F	E	F	E	I	N	A	N	D	N	D	W	D	I	H	W	S	W	D	R	
R	D	U	N	T	O	E	F	O	E	O	F	N	A	S	A	S	A	N	D	S	E	S	I	S	N	I	W	I
D	U	N	T	O	E	U	E	N	C	E	N	A	S	L	I	L	S	A	D	E	D	E	S	N	G	L	L	P
U	O	O	N	Q	E	Q	U	E	N	C	E	S	L	I	V	I	L	S	D	D	D	D	N	G	I	L	N	S
N	T	C	O	E	S	E	Q	U	E	N	C	E	E	F	E	V	I	D	N	A	N	N	G	I	S	E	O	P
T	I	N	C	O	N	S	E	Q	U	E	N	C	E	O	F	E	V	I	L	S	A	N	D	D	E	X	C	I
O	U	C	O	N	S	E	Q	N	E	N	C	E	E	F	I	V	I	L	S	A	N	I	S	E	S	I	F	C
Y	O	U	E	S	E	O	E	C	N	C	E	O	V	E	L	I	A	S	A	N	D	G	H	T	T	S	O	F
O	U	I	Q	U	Q	U	O	E	C	E	O	F	E	V	S	L	N	D	N	D	E	H	E	N	I	T	S	O
U	I	N	C	E	U	E	F	O	E	O	F	E	V	I	L	D	D	D	D	A	E	H	T	N	I	T	S	
I	N	C	O	N	C	N	E	F	O	F	E	V	S	L	S	E	S	E	D	A	E	H	E	H	T	N	R	A
N	C	O	N	C	E	I	V	E	V	E	V	I	A	S	I	S	I	S	E	R	A	E	H	E	H	T	T	E
C	O	E	S	U	S	L	I	V	I	V	I	L	N	D	D	I	G	I	S	C	F	O	E	H	E	H	E	H
O	N	Q	E	Q	A	S	L	S	L	S	L	D	D	D	E	S	N	O	C	F	O	S	A	E	H	E	H	E
N	E	U	Q	U	N	A	N	A	S	A	S	E	D	E	G	N	O	C	F	O	S	T	R	A	E	A	E	A
C	N	E	U	E	N	D	D	N	D	S	I	S	E	S	I	S	N	O	C	F	C	F	T	R	A	R	T	S
E	C	N	E	I	S	E	H	W	S	N	G	I	S	I	G	P	S	N	S	C	O	O	S	T	R	T	S	O
O	E	C	N	G	I	S	I	H	W	S	N	G	I	G	N	I	P	S	N	O	C	F	O	F	O	S	O	F
F	O	E	O	F	G	H	C	I	H	W	S	N	S	N	S	R	I	P	S	N	O	C	F	C	F	C	O	N
E	F	O	F	E	N	D	H	C	I	C	W	H	W	H	W	I	M	I	P	S	N	O	C	O	C	O	N	S
V	E	F	E	V	S	N	D	H	C	H	H	I	H	I	E	M	G	N	I	P	S	N	O	N	O	N	S	P
I	L	E	W	D	N	A	O	D	H	D	H	C	I	C	N	G	N	I	R	I	P	I	N	S	N	S	P	I

August 18–24

Doctrine and Covenants 89–92

“A Principle with Promise”

Instructions: Using the Across and Down clues, write the correct words in the numbered grid below. Hint: all of the words in the crossword come from the scripture below.

Doctrine and Covenants 89:18-21

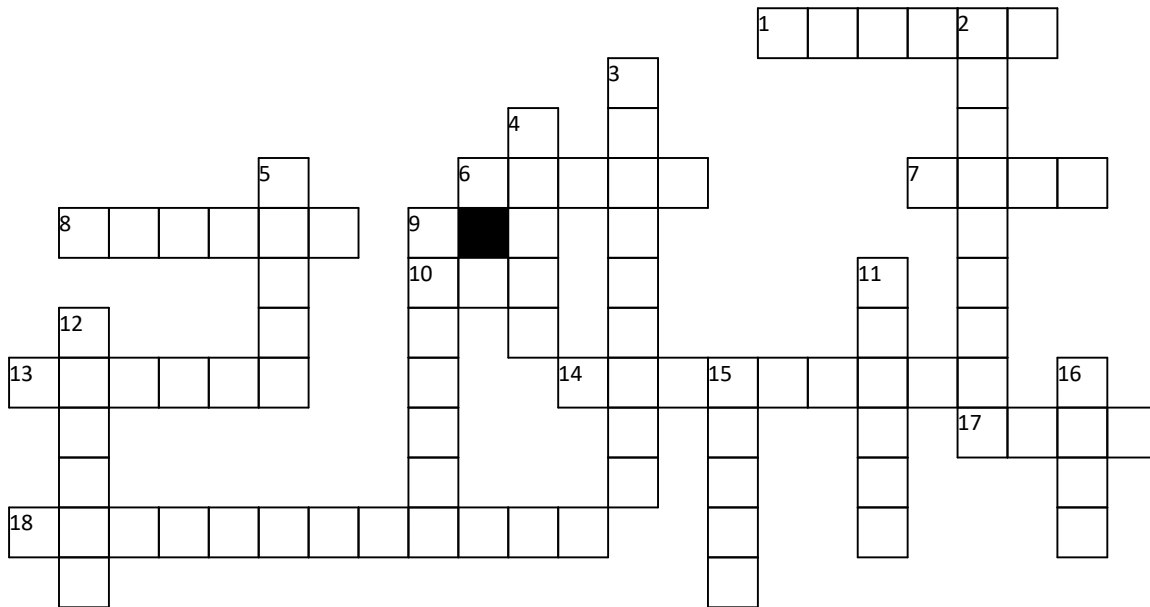

ACROSS

1. the general condition of body and mind
6. the stomach area where the belly button is
7. go across or through
8. the quality of having experience, knowledge, and good judgment
10. move fast by using one's feet
13. a faithful member of the Church of Jesus Christ
14. facts, information, and skills acquired by a person through experience or education
17. kill intentionally and with premeditation
18. the laws and requirements that God gives to mankind, either individually or collectively

DOWN

2. any possession that is highly valued by its owner
3. the trait of being willing to follow commands or guidance
4. weak and dizzy; close to losing consciousness
5. one of the hard parts of the skeleton
9. a verbal commitment agreeing to do or to not do something in the future
11. kept out of sight; concealed
12. network of connective tissue filling the cavities of bones
15. physically and mentally tired
16. use one's feet to advance; advance by steps

August 25–31

Doctrine and Covenants 93

“Receive of His Fulness”

Wacky Word Trails

Instructions: Start with the circled letter, use the clues to find and mark the trail of letters of all the connected bolded words from the scripture through the maze to the last letter. The path can wander up, down, left, and right at any point, even in the middle of the word.

Doctrine and Covenants 93:24, 28, 39

And **truth** is **knowledge** of **things** as they **are**, and as they **were**, and as they are to **come**;... He that **keepeth** his **commandments receiveth** truth and **light**, until he is **glorified** in truth and knoweth **all things**.... And that **wicked** one cometh and **taketh away** light and truth, through **disobedience**, from the **children** of men, and because of the **tradition** of their **fathers**.

N	I	H	A	K	N	O	C	Y	E	H	T	A	F	D
H	P	L	Y	H	A	I	B	W	R	S	T	C	K	E
R	W	U	C	E	F	U	T	X	D	A	R	I	R	E
I	T	E	E	R	T	U	R	T	I	T	J	W	E	W
O	H	V	I	E	H	W	T	N	O	I	P	E	T	H
W	C	O	M	R	A	F	B	H	J	Y	E	P	Z	O
L	G	K	M	A	N	R	N	A	T	H	E	K	R	D
F	D	U	Z	E	D	S	U	I	N	N	N	E	L	
C	B	T	F	E	M	N	B	S	S	E	D	C	H	I
F	W	A	Q	N	T	S	K	B	H	I	G	Q	S	G
K	O	E	L	A	W	A	G	T	E	F	A	O	G	N
F	T	D	W	Y	X	H	I	H	T	I	R	O	L	I
K	T	G	O	A	L	T	N	G	C	O	D	I	E	H
M	H	E	N	K	L	H	G	I	E	M	E	B	N	T
Z	V	T	A	K	E	T	S	L	D	I	S	O	C	E

Knight Moves - Find a Word

Instructions: Start with any letter in the puzzle to see if it's the beginning of a word. To get to the second letter, jump two squares in any direction except diagonally, and then one square in a different direction. Your path will look like a capital L. Only one route through the puzzle will make a word. Write the letters of the word you discover in the blanks below as you jump through the squares:

1 2 3 4 5 6 7 8

Now can you find this word in the following scripture?

Doctrine and Covenants 138:53

r	e	e
d		e
s	v	r

August 25–31

Doctrine and Covenants 93

“Receive of His Fulness”

Instructions: Fill in the blank puzzle grid using the word bank with the bold words from the scripture below. Place the words in the correct place on the grid.

Doctrine and Covenants 93:23, 29, 38

Ye were also in the **beginning** with the **Father**; that which is **Spirit**, even the Spirit of **truth**; **Man** was also in the beginning with God. **Intelligence**, or the **light of truth**, was not **created** or **made**, neither indeed can be. Every spirit of man was **innocent** in the beginning; and God having **redeemed** man from the **fall**, men became **again**, in their **infant state**, innocent before God.

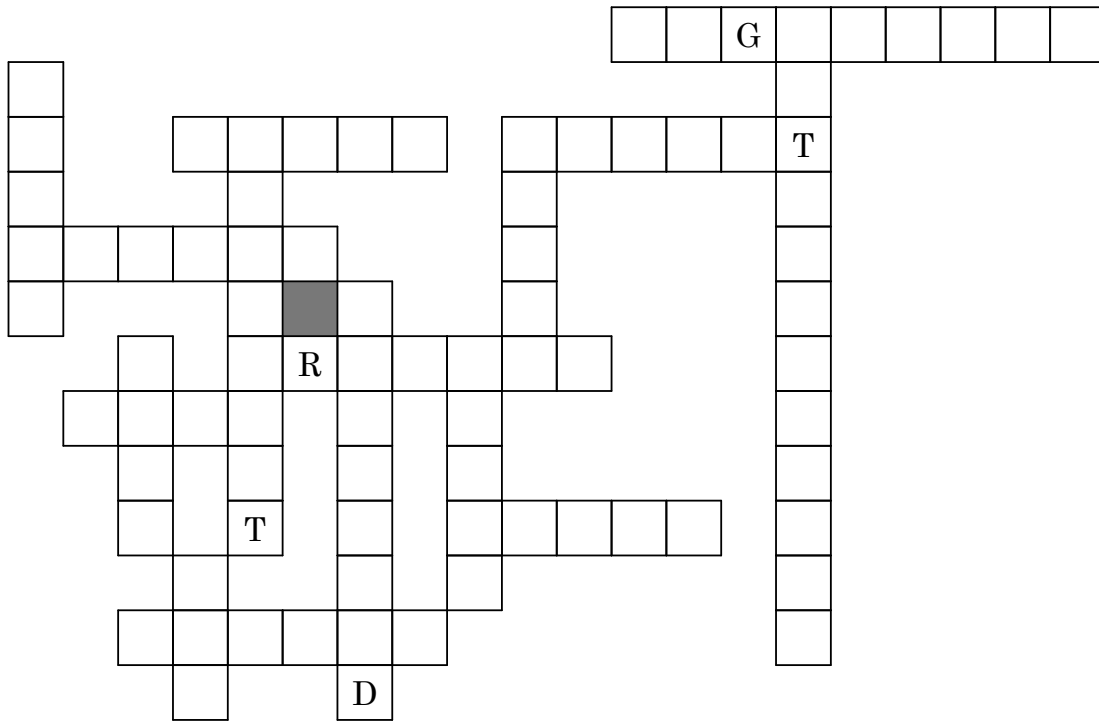

3 Letters	5 Letters	6 Letters	8 Letters	12 Letters
Man	truth	Father	innocent	Intelligence
	light	infant	redeemed	
4 Letters	truth	Spirit	9 Letters	
made	state		beginning	
fall	again	7 Letters		
		created		

.18 .72 .17
.71
.19 .69 .70
.68 .64 .63
67. .66 .65
.20 .61 .60 .62
.59
.58
.21 .57
.22 .56
.52 .53 .54
.23 .51
.50 .49 .55
.24 .48 .47
.25 .46
.26 .44
.27⁴⁵ .44
.2
.43
.28 .42
.41
.3 .29 .40
.30 .39
.31 .32 .38
.37
.4 .36
.5 .33 .35
.34
.6 .7
.73 .16
.74 .15
75. .77 .79
76. .85 .78
86. .84 .82 .14
87. .83 .81 .80
88. .90 .92
89. .93
.96
.94 .95 .97
.102 .101 .99 .13
.100 .98
.103 .123
.104 .121
.105 .122
.106 .107 .109 .119
.108 .110 .118
.111 .117
.112 .116
.113 .115 .10
.114 .11
.9
.8

August 25–31

Doctrine and Covenants 93

“Receive of His Fulness”

Jesus Christ is the Light and Life of the World.

Come, Follow Me 2025 Manual

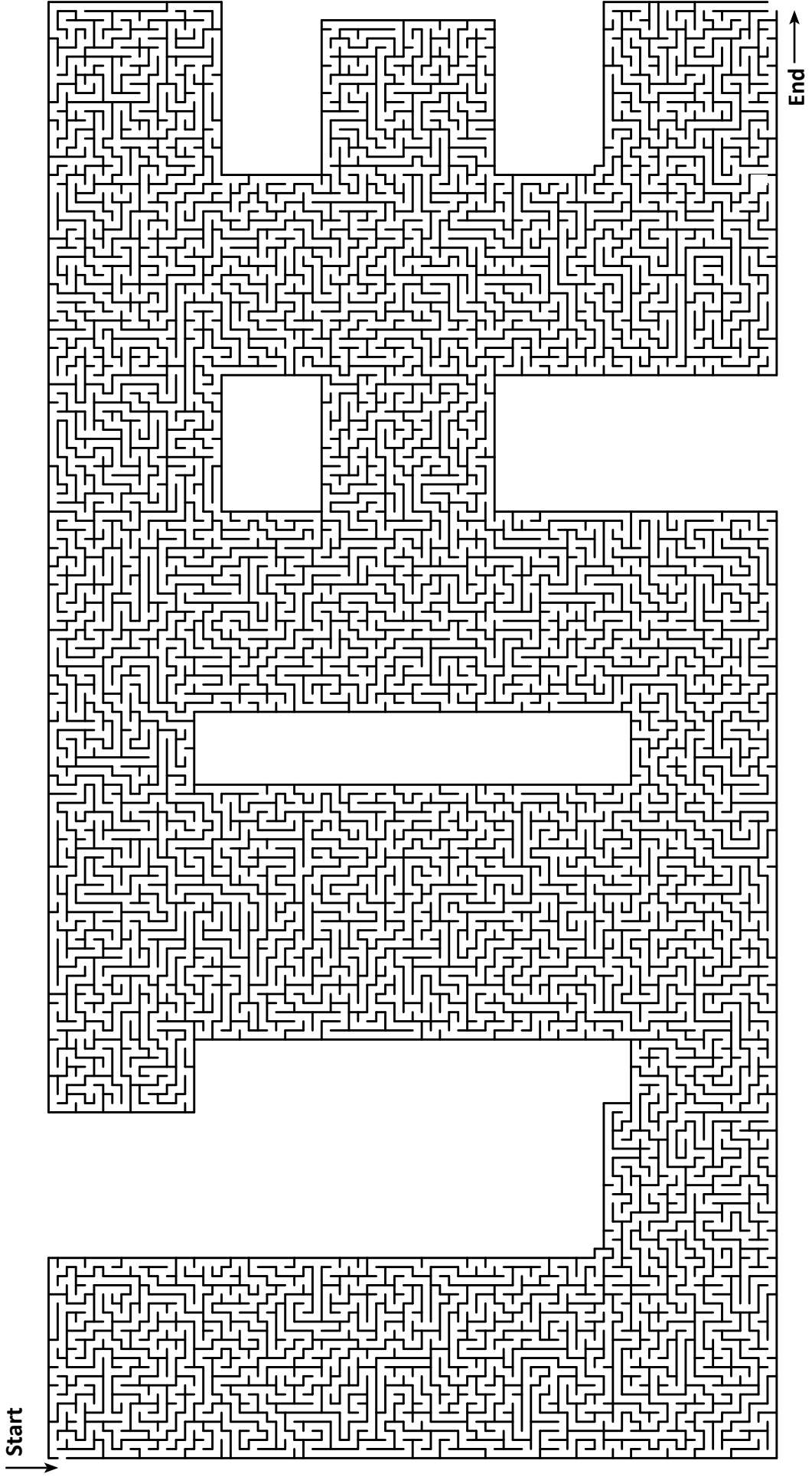

August 25–31

Doctrine and Covenants 93

“Receive of His Fulness”

mormoncartoonist.com

LET ME GET THIS STRAIGHT: I'VE LIVED FOR EONS AS A SPIRIT AND EXISTED BEFORE THAT FOREVER AS AN INTELLIGENCE, AND YET I STILL CAN'T DRIVE BEFORE MY SIXTEENTH BIRTHDAY?

THE LORD WORKS IN MYSTERIOUS WAYS.

© Arie Van De Graaff



Handwriting Practice

Practice your handwriting by tracing the sentence below. Then use the blank lines to write the sentence on your own.

I receive light and truth as I obey God.

Blank handwriting practice lines for independent writing.

September 1–7

Doctrine and Covenants 94–97

“For the Salvation of Zion”

Word Angles

Instructions: Find the bold words from the scripture. Each word path may run north, east, south, or west, may make one right-angled turn, and may cross another word path. A few words may make no right angle turn at all.

Doctrine and Covenants 97:15–16

And inasmuch as my **people build** a **house** unto me in the **name** of the **Lord**, and do not **suffer** any **unclean** thing to come **into** it, that it be not **defiled**, my **glory** shall **rest** upon it; Yea, and my **presence** shall be **there**, for I will **come** into it, and all the **pure** in **heart** that shall come into it shall **see God**.

C	U	K	G	M	R	R	U	Z	N	B	X	Z	D	A	P
F	X	C	M	C	V	O	G	H	E	V	I	P	U	I	E
V	A	O	S	E	H	D	N	O	U	S	E	E	L	P	O
N	E	M	X	L	M	T	K	S	N	V	P	E	Y	G	X
Z	J	N	Q	C	Z	R	B	O	B	Y	G	L	U	L	T
E	W	Q	C	V	F	A	E	H	O	K	C	I	R	N	S
U	F	Y	D	R	O	L	G	G	A	X	C	N	S	V	E
Y	H	K	P	E	G	Y	L	P	Y	E	B	T	O	P	R
H	J	Z	U	N	C	L	Y	U	R	E	B	D	A	H	T
I	O	D	E	F	I	E	H	V	C	I	U	C	H	E	V
X	J	I	B	Q	L	A	F	O	G	N	Q	Z	S	R	P
Z	D	N	L	F	E	N	X	P	H	H	Z	E	E	E	T
I	U	B	C	K	D	G	Q	M	H	H	K	E	Q	P	A
L	V	T	E	O	R	P	E	K	S	N	M	F	F	E	R
D	A	S	M	A	N	R	P	E	I	Q	G	U	C	W	N
Z	E	C	N	E	S	E	O	Y	R	O	L	S	Y	P	F

Word Guess

Instructions: Write your word guesses in the puzzle below. For extra hints, look at the words/phrases in the scripture below. Check the answer on ColorMeChristian.org

		M			N			N	
				G		T		D	
		N		H					
					W	I	H		W
	B		L				U		

Doctrine and Covenants 95:8

Yea, verily I say unto you, I gave unto you a commandment that you should build a house, in the which house I design to endow those whom I have chosen with power from on high;

Hidden Picture: Zion is the pure in heart. Can you find 3 copies of these citizens of Zion hidden in the city? It will be tricky; the pictures may be smaller, on their side, or even upside down! Then, see if you can find one copy of the animals as well.

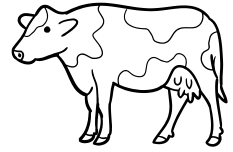
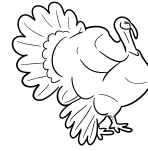
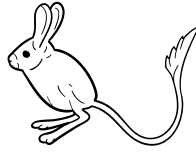

September 1–7

Doctrine and Covenants 94–97

“For the Salvation of Zion”

Reverse Word Search

Instructions: Instead of looking for words in a grid, place the bold words in the scripture in the empty word search puzzle. The words may be forwards, backwards, up, down, or diagonally. The start letter of the words have been placed in the grid to get you started.

General Handbook, 27.2

The word **endowment** means “a gift.” The **temple** endowment is literally a gift from God through which He blesses His children. The endowment can be **received** only in **holy** temples. Some of the gifts that members receive through the temple endowment include: Greater **knowledge** of the Lord’s **purposes** and **teachings**. **Power** to do all that Heavenly Father **wants** His children to do. **Divine direction** when **serving** the **Lord**, their **families**, and **others**. Increased **hope**, **comfort**, and **peace**. All the **promised blessings** of the endowment are in force both in this **life** and for **eternity**. The fulfillment of these blessings **depends** on **faithfulness** to the **gospel** of Jesus **Christ**.

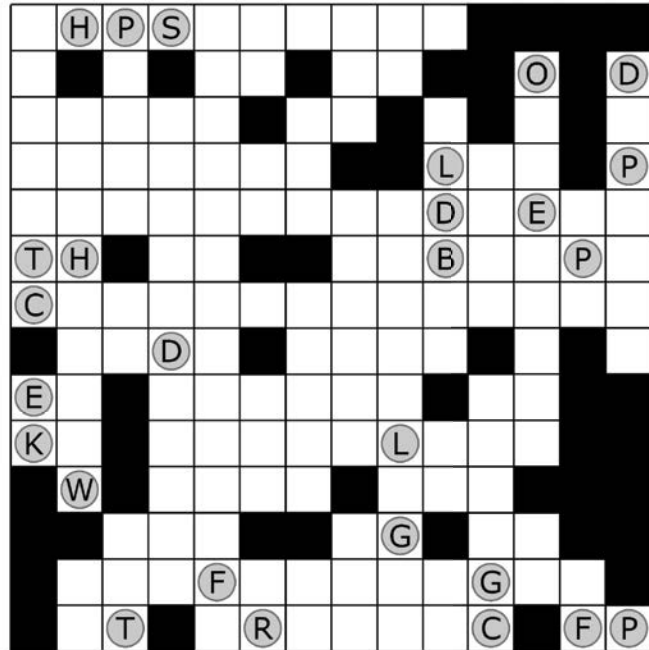

The Lord blesses people who keep covenants with Him.
Come, Follow Me 2025 Manual

Building the Temple

The Lord wants us to build temples. Can you take the tools and supplies through the maze to the temple site?

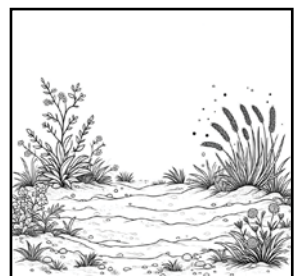
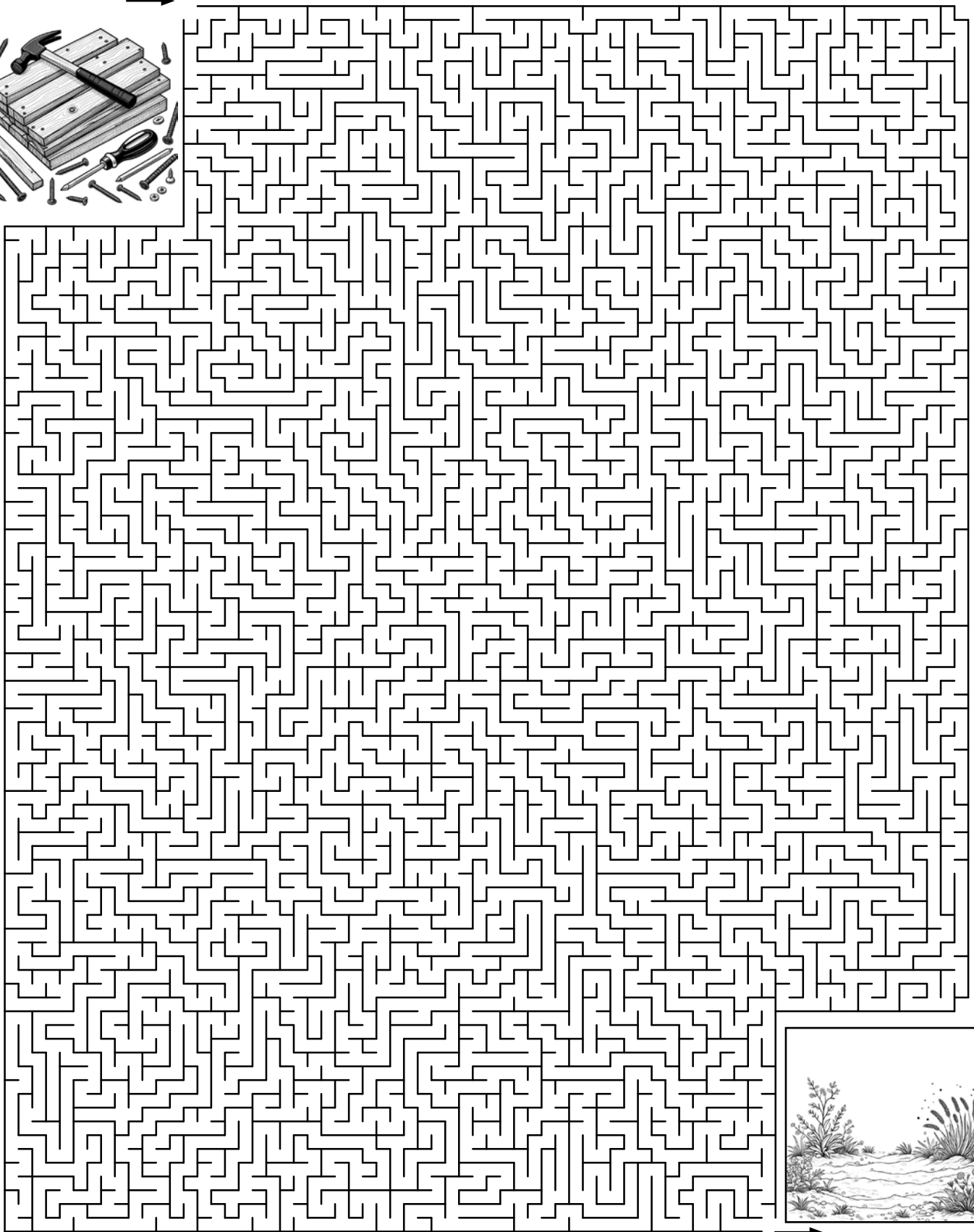
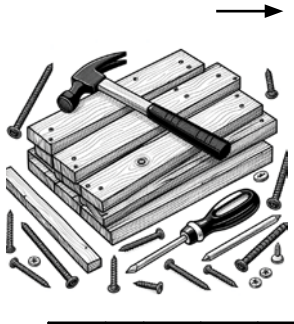

September 1–7

Doctrine and Covenants 94–97

“For the Salvation of Zion”



Letterbox Puzzle

Instructions: Find the hidden word in the puzzle below by crossing out all letters that occur twice or more. Capitalized and lowercase letters count as unique letters for this puzzle. The letters left over will form a word. Write down the left over letters like you would read a book, from left to right and top to bottom. Then find the hidden word in the scripture or phrase below and circle it.

Doctrine and Covenants 97:8–9

Verily I say unto you, all among them who know their hearts are honest, and are broken, and their spirits contrite, and are willing to observe their covenants by sacrifice—yea, every sacrifice which I, the Lord, shall command—they are accepted of me. For I, the Lord, will cause them to bring forth as a very fruitful tree which is planted in a goodly land, by a pure stream, that yieldeth much precious fruit.

Write the hidden word:

l	p	H	Q	r	†
k	g	G	e	H	M
L	k	C	c	m	i
z	O	L	G	c	Q
M	U	†	I	d	z
m	B	g	s	B	d

September 8–14

Doctrine and Covenants 98–101

“Be Still and Know That I Am God”



Therefore, let your hearts be comforted concerning Zion; for all flesh is in mine hands; be still and know that I am God.

Doctrine and Covenants 101:16

September 8–14

Doctrine and Covenants 98–101

“Be Still and Know That I Am God”

Word Search

Instructions: Find the bold words from the scripture in the word search puzzle. Each word could be hidden forwards, backwards, up, down, or diagonally.

Doctrine and Covenants 98:2–3

Waiting patiently on the Lord, for your prayers have entered into the ears of the Lord of Sabaoth, and are recorded with this seal and testament—the Lord hath sworn and decreed that they shall be granted. Therefore, he giveth this promise unto you, with an immutable covenant that they shall be fulfilled; and all things wherewith you have been afflicted shall work together for your good, and to my name’s glory, saith the Lord.

H R E C O R D E D P C L Q N L
G N I T I A W S R Y Z I F A G
E K D D Q R G A Q R S L K M N
D R I X J N Y X C O R O K E R
E O G E I E Y H K L A R V S O
L W L H R W L T V G E D D Z W
L A T S I E T D E C R E E D S
I F G U B L N E S I M O R P G
F F O T O G E T H E R L A E S
L L O I H T I W E R E H W G D
U I D Q G M T E S T A M E N T
F C N E L B A T U M M I U X U
F T J I J Q P D E R E T N E S
D E T N A R G W W H A L L I A
E D C O V E N A N T W J M I Z

Fill in the Blank

Doctrine and Covenants 98:39–40

And again, verily I say unto you, if after thine _____ has come upon thee the _____ time, he _____ and come unto thee _____ thy _____, thou _____ forgive him, and shalt _____ it no more as a _____ against thine enemy—And so on unto the _____ and _____ time; and as _____ as thine enemy _____ of the _____ wherewith he has trespassed against thee, thou shalt forgive _____, until _____ times _____.

testimony	second	third	first	seven	him
praying	shalt	hold	trespass	seventy	enemy
repenteth	forgiveness	repent	oft		

September 8–14

Doctrine and Covenants 98–101

“Be Still and Know That I Am God”

Word Spiral

Instructions: Fill in the blank puzzle grid using the bold words from the scripture or phrase below. *The bold words may not all be used!* Use the letter hint below and count the letters of the bold words to figure out where each word goes. Then transfer the letters that have little numbers in their box to the hidden word at the bottom of the puzzle. Check the answer on ColorMeChristian.org.

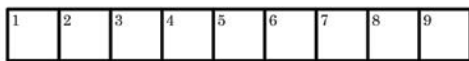
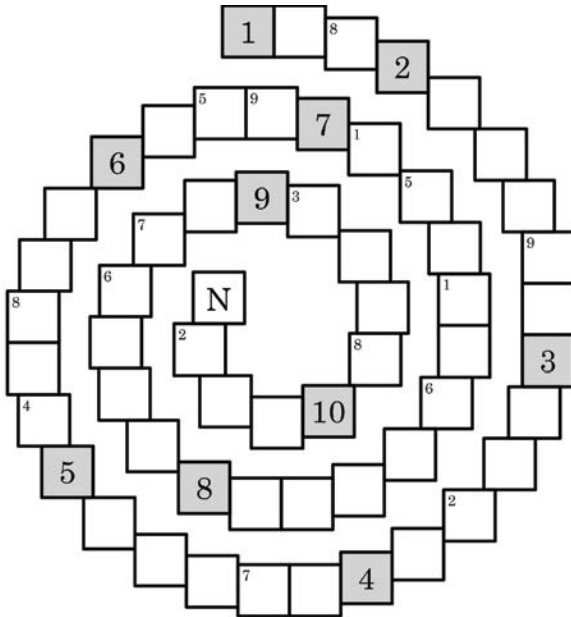

Doctrine and Covenants 101:16

Therefore, let your **hearts** be **comforted concerning Zion**; for **all flesh** is in **mine hands**; **be still** and **know** that I am **God**.

Word Star

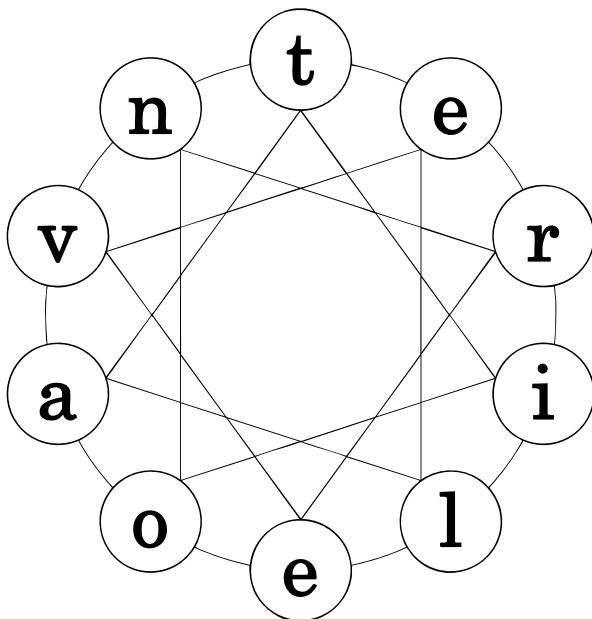

Instructions: Only one route through the word star will make a word. Try each letter and follow the pathway through the star to see if it makes a word.. IF you need a hint, look at the words in the scripture below. Write the letters of the word you discover in the blanks below as you travel through the star:

Now can you find this word in the following scripture?

Doctrine and Covenants 101:23

September 8–14

Doctrine and Covenants 98–101

“Be Still and Know That I Am God”

Instructions: Using the Across and Down clues, write the correct words in the numbered grid below. Hint: all of the words in the crossword come from the scripture below.

Doctrine and Covenants 101:23–32

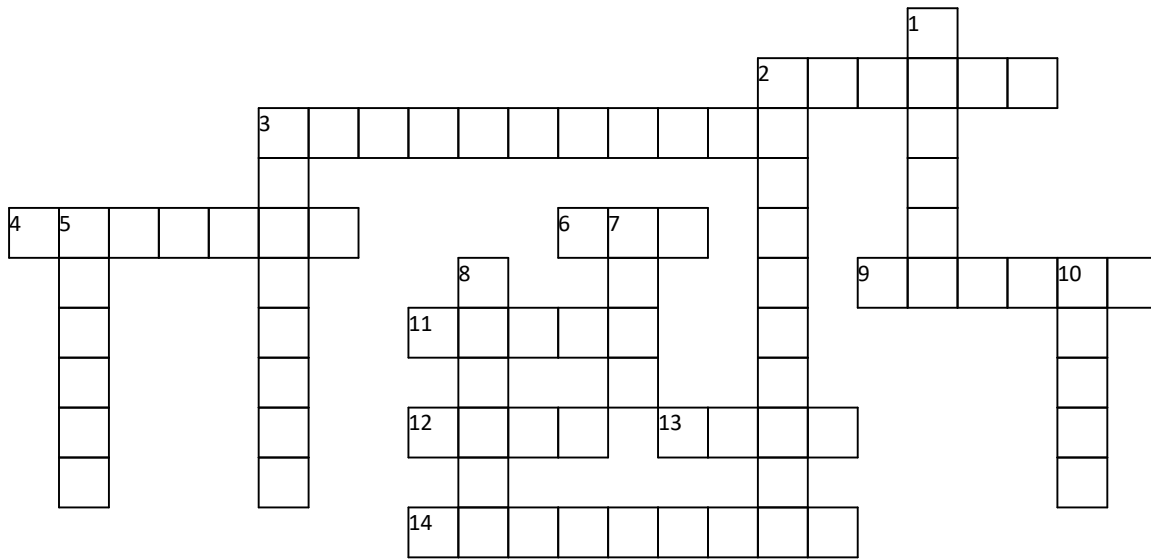

ACROSS

2. make visible
3. something that can go from good to bad
4. characterized by intense emotion
6. the opposite of on
9. an animal
11. a bird of any kind
12. a tall woody plant with a main trunk and branches and leaves
13. a symbol for a separation between God and man
14. shining intermittently with a sparkling light

DOWN

1. the literal house of the Lord
2. communication from God to His children on earth.
3. to do away with completely, to destroy
5. a state of deep-seated ill-will; hostile to someone or something
7. an aquatic animal
8. an emotion of great sadness associated with loss
10. to try to persuade someone to do something wrong

September 8–14

Doctrine and Covenants 98–101

“Be Still and Know That I Am God”

Word Sudoku

Instructions: Solve this word sudoku puzzle the same way that you’d solve a numeric sudoku. Each of the bold words in the scripture below is found once in every row, column and 3×3 box.

Doctrine and Covenants 98:23

Now, I speak unto you concerning your families—if men will **smite** you, or your families, **once**, and ye **bear** it **patiently** and **revile not** against them, neither **seek revenge**, ye shall be **rewarded**;

	revenge	bear				once		
rewarded	revile		patiently				not	
not			revenge				seek	
			once			smite	revenge	rewarded
revenge		rewarded		smite				
	bear		not			patiently	revile	
once			bear			seek		
	seek		rewarded	once		revenge		
	smite			not	revile			once

September 15–21

Doctrine and Covenants 102–105

“After Much Tribulation ... Cometh the Blessing”

Cryptogram

Instructions: Each letter on the top stands for a letter in the alphabet. Solve the encrypted phrase by matching each letter on top to a letter in the alphabet on the bottom. Use the key to help you remember what the letters stand for so you can crack the code.

Z	Q	I	E	A	F	H	T	D	W	B	Y	U	S	K	V	P	L	N	C	J	R	G	O	M	X
A	B	C	D	E	F	G	H	I	J	K	L	M	N	O	P	Q	R	S	T	U	V	W	X	Y	Z

E S I C S E N Y M T G E N G D C N F E C H G F M R

C S O D D Q C S W Y L T X Y Y E S I Y D S H N ,

J G C T G C G E P D W C P D S M S H X G C Y , C

J C R R Y M R H C Q R L K R D N N C S W N M Q X S

G C Y E S I G C N N D D I E F H D V G C Y ,

D P D S E Y M R H C Q R C T C H L X F

K R D N N C S W N . I X T H V C S D E S I

T X P D S E S H N 1 0 4 : 4 2



September 15–21

Doctrine and Covenants 102–105

“After Much Tribulation ... Cometh the Blessing”

Missing Vowels Word Search

Instructions: Find the hidden words. The words have been placed horizontally, vertically, diagonally, forwards, or backwards, and the vowels have been removed. When you locate a word, draw an ellipse around it and fill the vowels in.

Doctrine and Covenants 104:13–16

For it is expedient that I, the Lord, should make every man **accountable**, as a **steward** over **earthly blessings**, which I have made and **prepared** for my **creatures**. I, the Lord, **stretched** out the **heavens**, and **built** the **earth**, my very handiwork; and all things therein are **mine**. And it is my **purpose** to **provide** for my **saints**, for all things are mine. But it must needs be done in mine **own way**; and behold this is the way that I, the Lord, have **decreed** to provide for my saints, that the **poor** shall be **exalted**, in that the **rich** are made **low**.



Unscrambler

Instructions: Unscramble the words below; look at the bold words in the scripture for a hint.

Doctrine and Covenants 104:18

Therefore, if any man shall **take** of the **abundance** which I have **made**, and **impart** not his **portion**, according to the law of my **gospel**, unto the **poor** and the **needy**, he shall, with the **wicked**, **lift** up his **eyes** in hell, being in **torment**.

timpar _____

enttorm _____

orpo _____

nceabunda _____

dynee _____

edwick _____

seye _____

emad _____

lgospe _____

tlif _____

onporti _____

etak _____

Waiting at Martin's Cove

Pioneers stopped at Martin's Cove in Wyoming to wait for a storm to pass.

Find the pattern in each row from left to right. Then find the objects that complete the patterns. Write the letter for each object in the empty boxes. Then write them in the spaces below to find out what the pioneers needed to do during their hard journey.



D



E



L

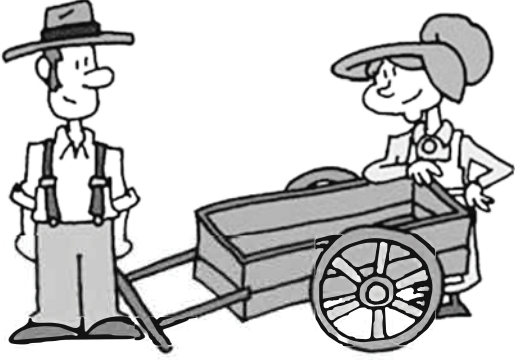





N



























R



U



W

September 15–21

Doctrine and Covenants 102–105

“After Much Tribulation ... Cometh the Blessing”



Word Square

Instructions: Word squares are a liike Sudoku puzzles, but each letter can occur only once in each row and in each column. Check your puzzle against the answer key on ColorMeChristian.org. Every row and column must contain every letter in the word **LIGHT**. This word can be written in the gray row.

Doctrine and Covenants 103:9

For they were set to be
a **light** unto the world, and to be
the saviors of men;

			T	
		H		T
	T			H
	G		I	L
		L		

September 15–21

Doctrine and Covenants 102–105

“After Much Tribulation ... Cometh the Blessing”

Instructions: Connect all of the letters in the maze and then write the phrase in the blanks below. Don't be tricked by letters that take you into a dead end! There is only one path through the maze.

-----, -----;
-----,
-----.

Doctrine and Covenants 104:13

Finish

Start

N	M	E	H	T	O	T	S	E	V	L	E	S	M	E	H	T	H	E	M	F	S	F	O
E	S	H	T	O	T	O	F	M	L	E	S	M	E	H	T	O	L	E	S	S	E	O	R
S	I	T	O	T	N	T	M	E	H	T	O	T	H	T	O	T	O	T	E	L	V	R	T
R	E	O	T	N	U	N	T	H	T	O	T	N	U	S	U	N	T	O	L	S	E	T	H
E	R	T	N	U	S	U	N	E	O	T	N	U	N	T	S	T	O	E	V	F	S	H	E
H	E	N	U	S	T	S	E	G	A	E	A	S	T	N	U	O	T	S	E	O	R	E	E
T	H	U	S	T	N	E	G	E	E	B	E	T	S	E	N	T	H	F	O	R	T	H	A
D	T	S	T	N	E	G	A	G	B	O	B	N	E	G	E	N	T	O	R	M	E	N	T
N	D	T	H	T	G	A	E	A	O	T	O	B	E	A	G	E	N	T	O	F	M	E	O
A	N	D	T	H	E	E	B	O	T	N	A	E	E	G	T	N	F	E	N	O	F	N	B
L	A	N	D	T	G	A	E	T	N	E	M	F	O	F	E	N	O	R	E	N	O	F	M
L	L	A	N	D	T	O	T	N	E	M	F	O	N	E	R	D	L	D	R	E	N	O	B
U	L	L	A	N	D	T	N	U	N	T	O	T	H	E	C	H	I	R	E	N	O	F	O
F	U	L	L	A	N	H	E	N	U	O	T	I	H	C	H	I	L	D	R	E	N	O	T
S	F	U	L	E	R	E	V	E	N	T	H	L	I	H	I	L	D	R	O	F	M	E	N
I	U	L	H	I	S	R	I	V	E	H	E	V	L	I	L	D	N	E	N	O	F	M	E
H	I	R	T	N	I	E	G	I	V	E	H	A	V	L	D	R	E	N	O	F	M	T	O
T	R	A	R	E	S	I	E	V	A	N	D	N	A	N	D	E	N	O	F	M	E	N	B
H	T	E	A	N	E	S	E	E	H	D	N	A	S	D	H	A	V	E	G	E	N	T	O
T	E	E	N	A	N	E	N	G	I	H	D	N	G	N	D	H	A	V	E	G	I	V	B
R	T	H	A	H	G	N	O	U	V	A	H	D	N	A	S	A	N	D	H	I	V	E	G
O	N	A	H	G	U	O	U	G	A	V	A	H	I	N	G	S	A	H	D	H	A	V	E
F	D	T	R	A	R	E	Y	E	S	G	H	T	H	I	N	G	S	A	N	D	H	E	G
O	T	O	S	P	E	Y	E	A	D	N	T	L	T	H	I	N	G	S	A	N	A	V	E
R	O	S	P	E	Y	E	A	R	E	I	L	L	H	I	S	G	S	A	N	D	H	A	V
P	S	P	I	A	E	A	I	P	R	H	T	A	L	L	A	S	A	S	A	N	D	H	A
A	E	R	P	I	A	R	A	P	A	R	E	D	A	L	H	I	N	G	S	A	N	A	V
R	P	E	R	P	I	P	R	E	P	E	D	A	L	L	T	H	I	S	A	N	D	H	E

September 15–21

Doctrine and Covenants 102–105

“After Much Tribulation ... Cometh the Blessing”

Instructions: Fit the bold words from the scripture below into the encircled squares. Words will read forward, backward, up, down, and diagonally and will normally cross other words. Start with the hints provided.

Doctrine and Covenants 105:38–40

And again I say unto you, **sue** for **peace**, not only to the **people** that have **smitten** you, but also to **all** people; And **lift** up an **ensign** of peace, and **make** a **proclamation** of peace unto the **ends** of the **earth**; And make **proposals** for peace unto those who have smitten you, according to the **voice** of the **Spirit** which is in you, and all **things** shall **work together** for your **good**.

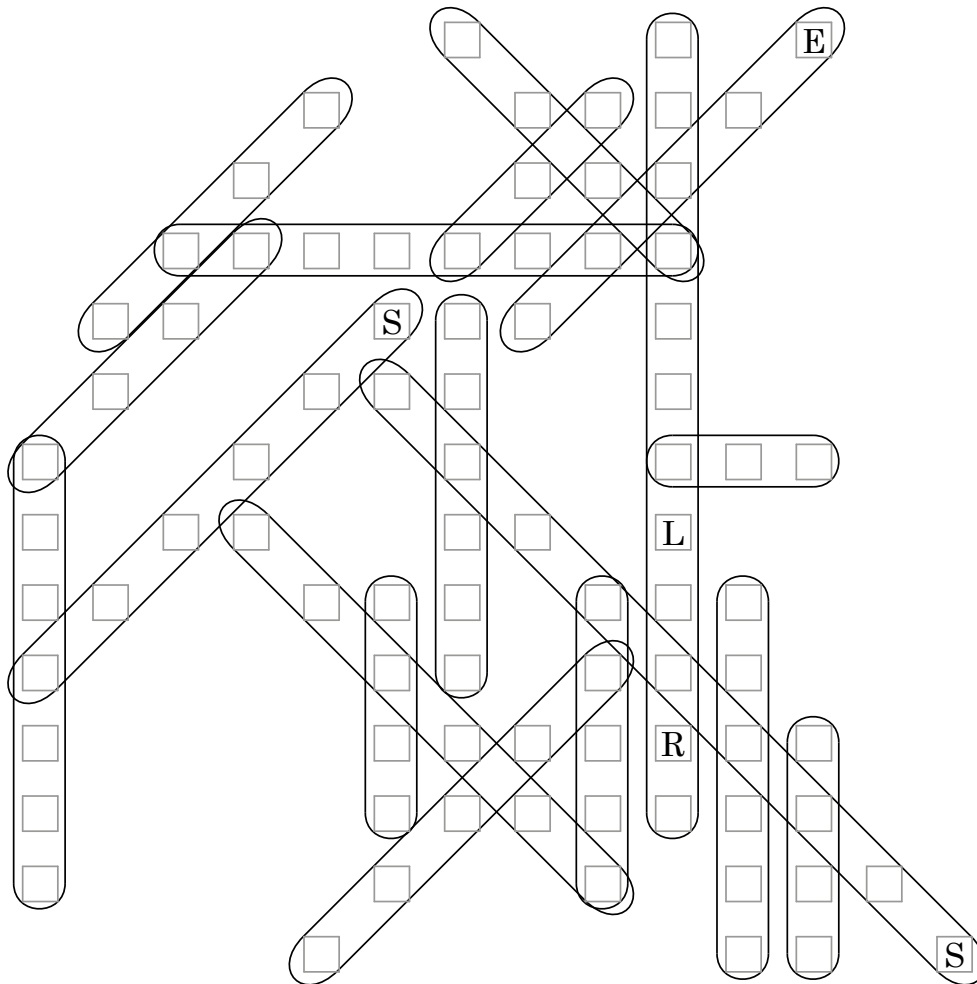

sue
lift
earth
work

peace
ensign
proposals
together

people
make
voice
good

smitten
proclamation
Spirit

all
ends
things

September 22–28

Doctrine and Covenants 106–108

“The Order of the Son of God”

Wacky Word Trails

Instructions: Start with the circled letter, use the clues to find and mark the trail of letters of all the connected bolded words from the scripture through the maze to the last letter. The path can wander up, down, left, and right at any point, even in the middle of the word.

Doctrine and Covenants 107:91–92

And again, the **duty** of the **President** of the **office** of the **High Priesthood** is to **preside** over the whole **church**, and to be like unto **Moses**—Behold, here is **wisdom**; yea, to be a **seer**, a **revelator**, a **translator**, and a **prophet**, having **all** the **gifts** of **God** which he **bestows** upon the **head** of the **church**.

E	N	E	A	I	E	S	T	O	H	E	M	F	W	I
D	T	H	D	B	B	H	C	W	P	T	H	I	Q	O
I	S	F	G	O	D	C	R	S	O	H	P	G	E	N
R	E	B	G	A	N	H	U	P	R	O	T	H	A	Y
P	R	O	F	S	D	K	R	C	K	A	D	L	L	K
R	O	F	A	O	O	P	W	Y	C	X	U	T	O	Q
A	T	Q	C	H	T	S	E	I	X	H	U	Y	I	D
L	E	V	E	I	F	H	B	R	P	S	T	P	S	E
E	K	E	W	Y	J	N	U	F	F	I	F	R	E	M
H	M	R	M	R	Z	G	N	O	I	G	S	E	S	O
U	B	H	C	O	O	R	S	Z	C	E	T	I	L	X
Y	H	U	R	R	B	G	K	O	B	A	R	M	V	I
W	C	E	S	M	A	I	C	G	I	N	E	V	K	C
Y	R	E	D	O	Q	V	T	A	L	S	K	N	S	Q
T	O	P	S	I	W	R	O	C	V	Y	Z	A	S	M

Knight Moves - Find a Word

Instructions: Start with any letter in the puzzle to see if it’s the beginning of a word. To get to the second letter, jump two squares in any direction except diagonally, and then one square in a different direction. Your path will look like a capital L. Only one route through the puzzle will make a word. Write the letters of the word you discover in the blanks below as you jump through the squares:

1 2 3 4 5 6 7 8

Now can you find this word in the following scripture?

Doctrine and Covenants 107:23

o	s	t
l		p
a	s	e

Mystery Picture Graph

Instructions: Find the mystery picture below by plotting and connecting the points of each line on the coordinate graph. Connect all the points in Line 1, stop, pick up your pencil, and then connect all the points in Line 2, and so on for the rest of the lines. The dot for the first (X,Y) coordinate pair on Line 1 has been placed for you.

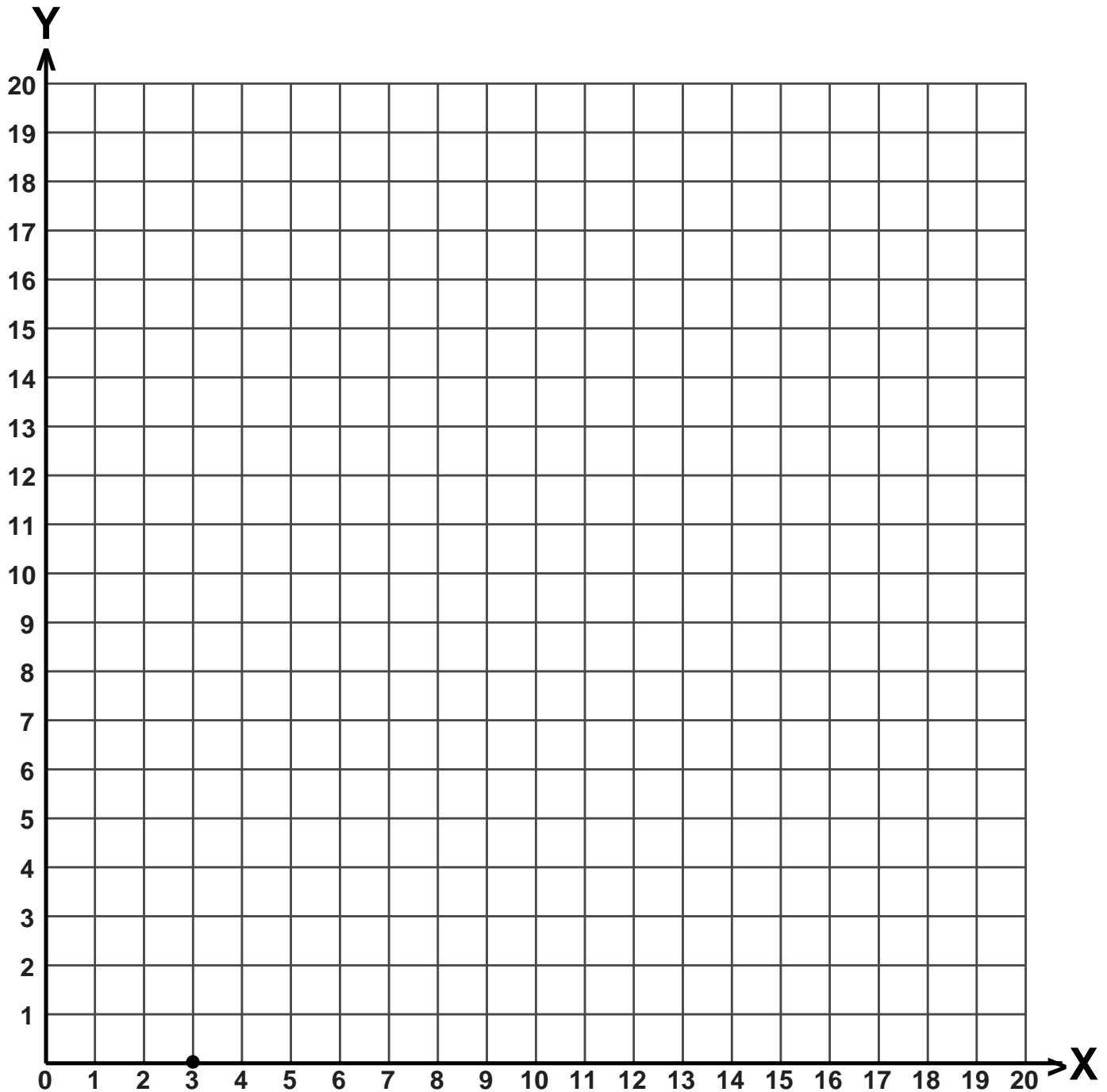

Line 1	(3, 0)	(17, 0)	(19, 2)	(20, 2)	(20, 3)	(0, 3)	(0, 2)	(1, 2)	(3, 0)	Line 2	(1, 2)	(19, 2)
Line 3	(1, 3)	(1, 4)	(2, 4)	(2, 3)	Line 4	(3, 3)	(3, 4)	(4, 4)	(4, 3)	Line 5	(5, 3)	(5, 4)
(6, 4)	(6, 3)	Line 6	(7, 3)	(7, 4)	(8, 4)	(8, 3)	Line 7	(9, 3)	(9, 4)	(10, 4)	(10, 3)	Line 8
(11, 3)	(11, 4)	(12, 4)	(12, 3)	Line 9	(13, 3)	(13, 4)	(14, 4)	(14, 3)	Line 10	(15, 3)	(15, 4)	(16, 4)
(16, 3)	Line 11	(17, 3)	(17, 4)	(18, 4)	(18, 3)	Line 12	(19, 3)	(19, 6)	(17, 8)	(3, 8)	(1, 6)	(1, 4)
Line 13	(18, 4)	(18, 6)	(17, 7)	(3, 7)	(2, 6)	(2, 4)						

September 22–28

Doctrine and Covenants 106–108

“The Order of the Son of God”

Letter Sudoku

Instructions: Solve the letter sudoku puzzle the same way you’d solve a numeric sudoku. Check your puzzle against the answer key on ColorMeChristian.org. Every column, row, and group of nine must contain every letter in the word(s) **TRAVELING**.

Doctrine and Covenants 107:33

The Twelve are a **Traveling** Presiding High Council, to officiate in the name of the Lord, under the direction of the Presidency of the Church, agreeable to the institution of heaven; to build up the church, and regulate all the affairs of the same in all nations, first unto the Gentiles and secondly unto the Jews.

L	V	A		N	R			
					T		I	V
	I	R			E			
E				A			G	
	G			I				
		V	N				R	
	N							
A	L		G					E
			E	T				A

Translation Station

Instructions: Translate the sign language letters below into English to discover the hidden message. Write the alphabet letter beneath each hand sign. Use the key at the back of the book to help you.

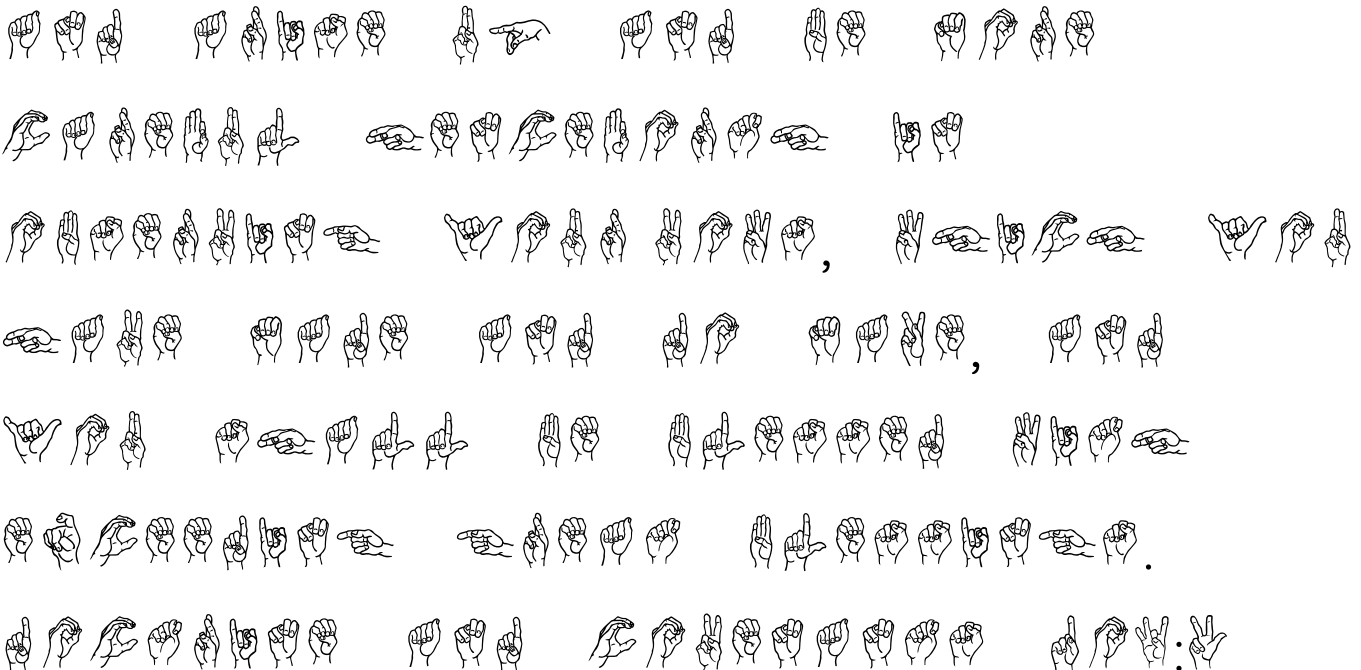

September 22–28

Doctrine and Covenants 106–108

“The Order of the Son of God”

Instructions: Fill in the blank puzzle grid using the word bank with the bold words from the scripture below. Place the words in the correct place on the grid.

Doctrine and Covenants 107:18–19

The **power** and **authority** of the **higher**, or **Melchizedek Priesthood**, is to **hold** the **keys** of all the **spiritual blessings** of the **church**—To have the privilege of **receiving** the **mysteries** of the **kingdom** of **heaven**, to have the heavens **opened** unto them, to **commune** with the **general assembly** and church of the **Firstborn**, and to enjoy the communion and **presence** of God the **Father**, and **Jesus** the **mediator** of the **new covenant**.

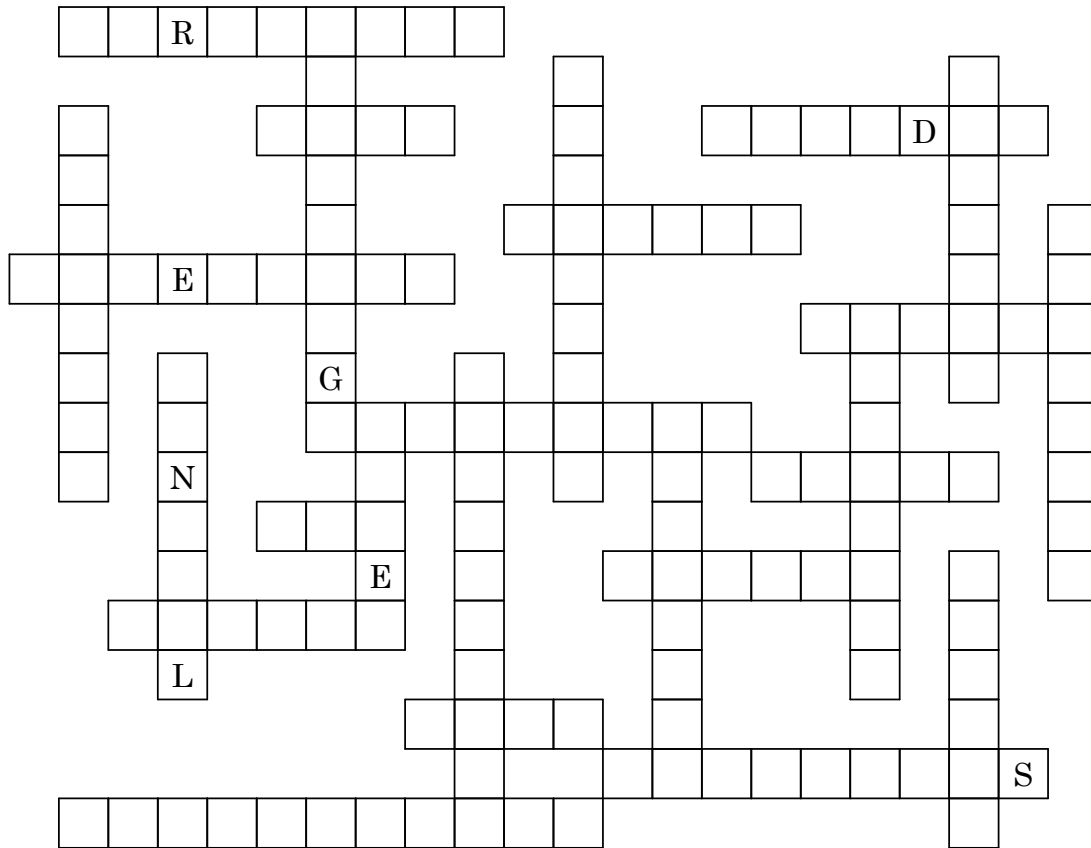

3 Letters new	Jesus	7 Letters commune kingdom general	covenant	10 Letters Priesthood
4 Letters hold keys	6 Letters heaven higher Father opened church	8 Letters assembly presence mediator	9 Letters spiritual mysteries authority blessings receiving Firstborn	11 Letters Melchizedek
5 Letters power				

September 22–28

Doctrine and Covenants 106–108

“The Order of the Son of God”

The Lord’s chosen servants **lead** His Church.

Come, Follow Me 2025 Manual

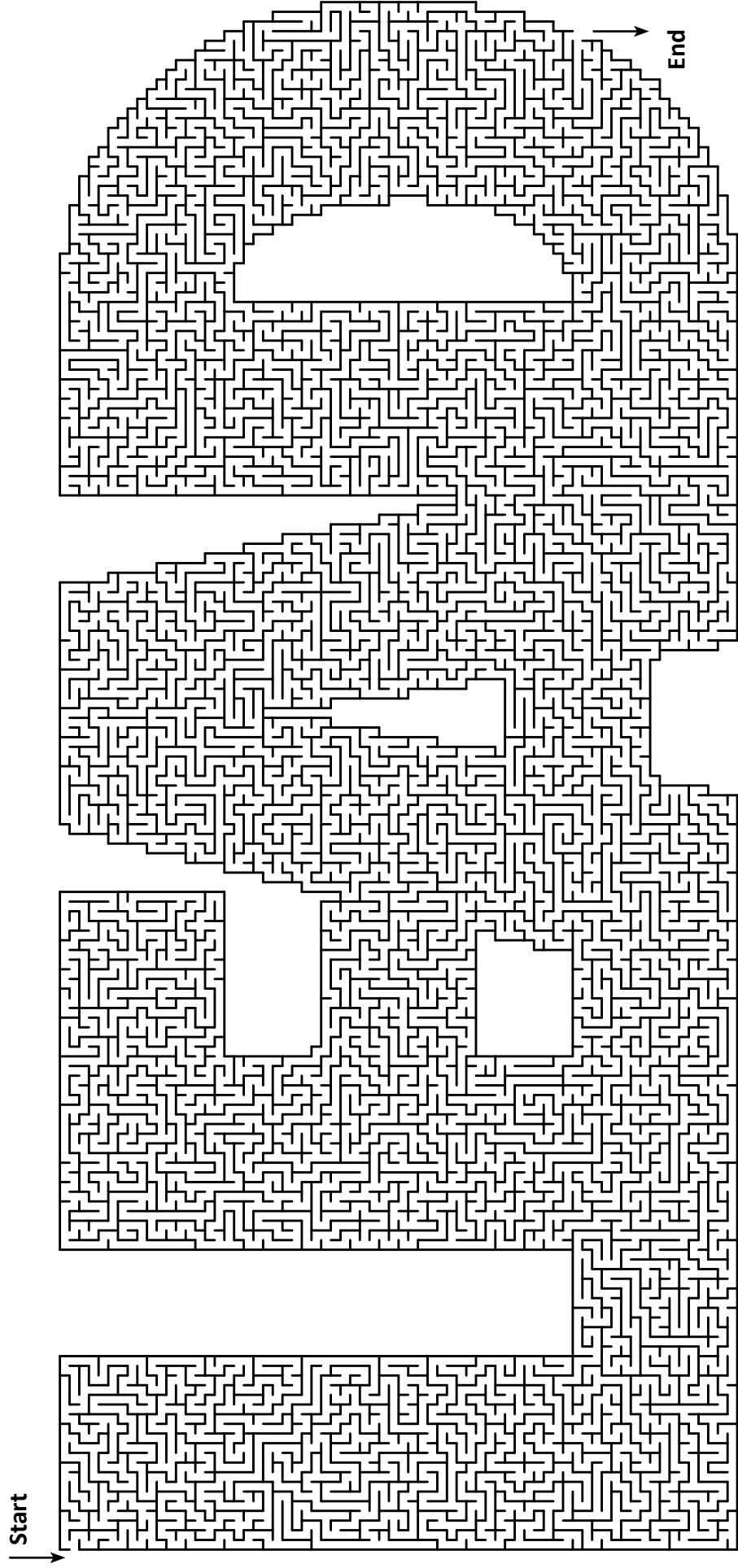

September 22–28

Doctrine and Covenants 106–108

“The Order of the Son of God”



Handwriting Practice

Practice your handwriting by tracing the sentence below. Then use the blank lines to write the sentence on your own.

*I can be careful in living
my covenants.*

September 29–October 5

Doctrine and Covenants 109–110

“It Is Thy House, a Place of Thy Holiness”

Reverse Word Search

Instructions: Instead of looking for words in a grid, place the bold words in the scripture in the empty word search puzzle. The words may be forwards, backwards, up, down, or diagonally. The start letter of the words have been placed in the grid to get you started.

Doctrine and Covenants 110:2-3

We saw the **Lord standing** upon the breastwork of the **pulpit**, before us; and under his **feet** was a **paved** work of pure **gold**, in color like **amber**. His **eyes** were as a **flame** of **fire**; the **hair** of his head was **white** like the pure **snow**; his **countenance shone** above the **brightness** of the **sun**; and his **voice** was as the **sound** of the **rushing** of great **waters**, even the voice of **Jehovah**, saying:

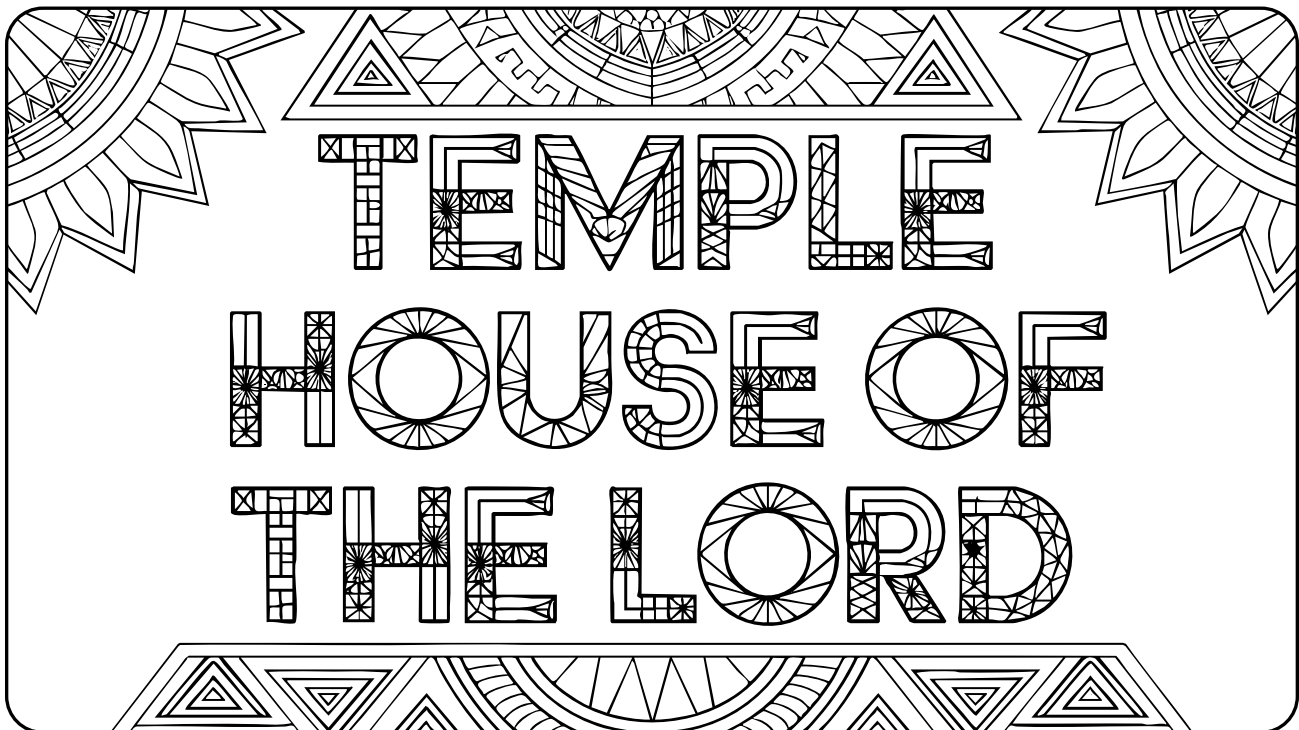
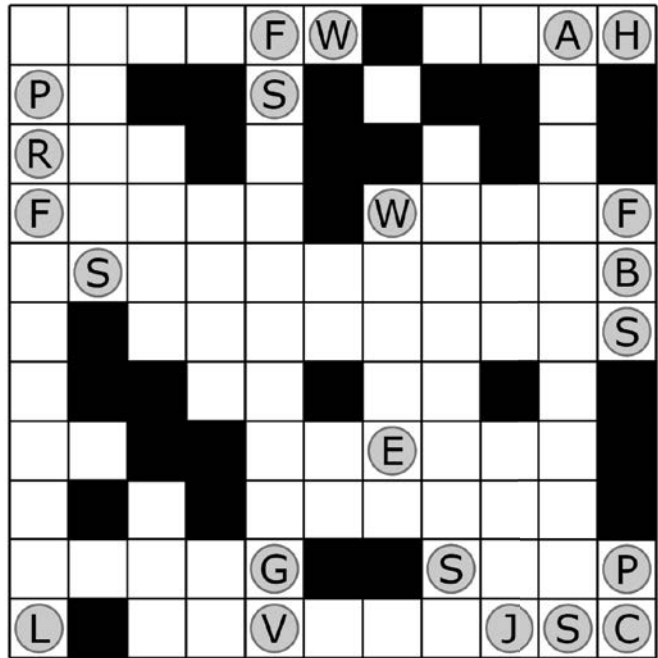

Find the Differences

By Arie Van De Graaff

Kirtland, Ohio, was where the first temple was built after the gospel was restored. See if you can find 10 differences between these two pictures of neighbors walking outside the temple.

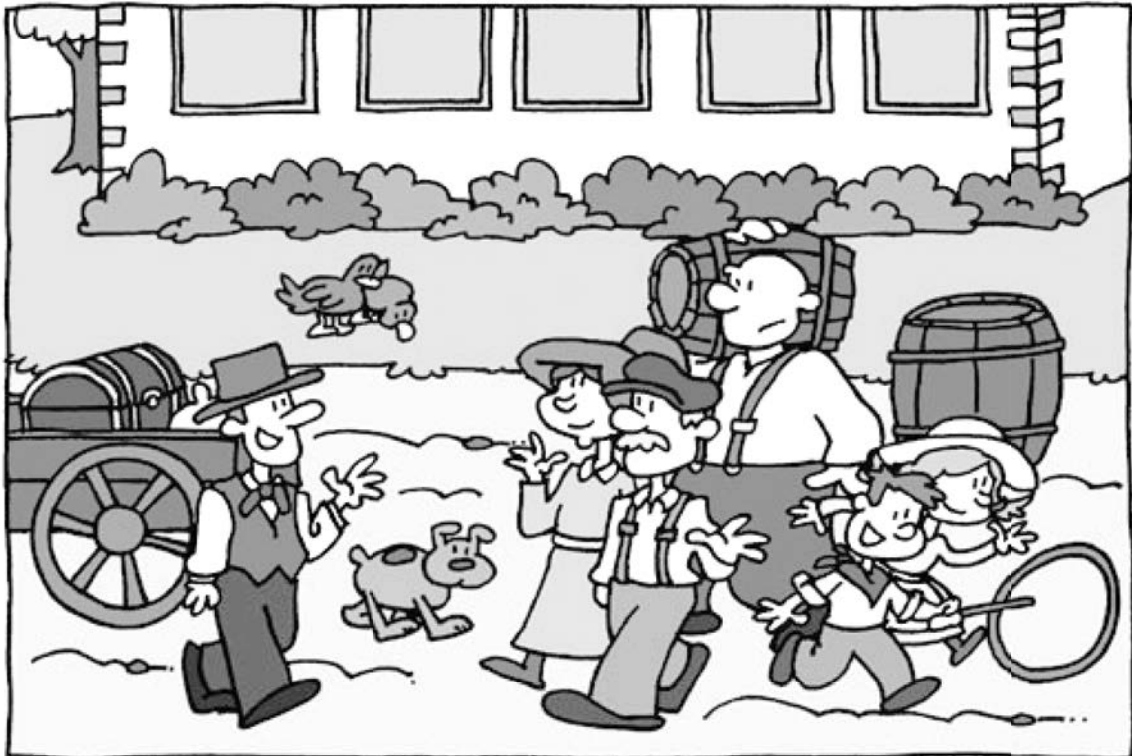
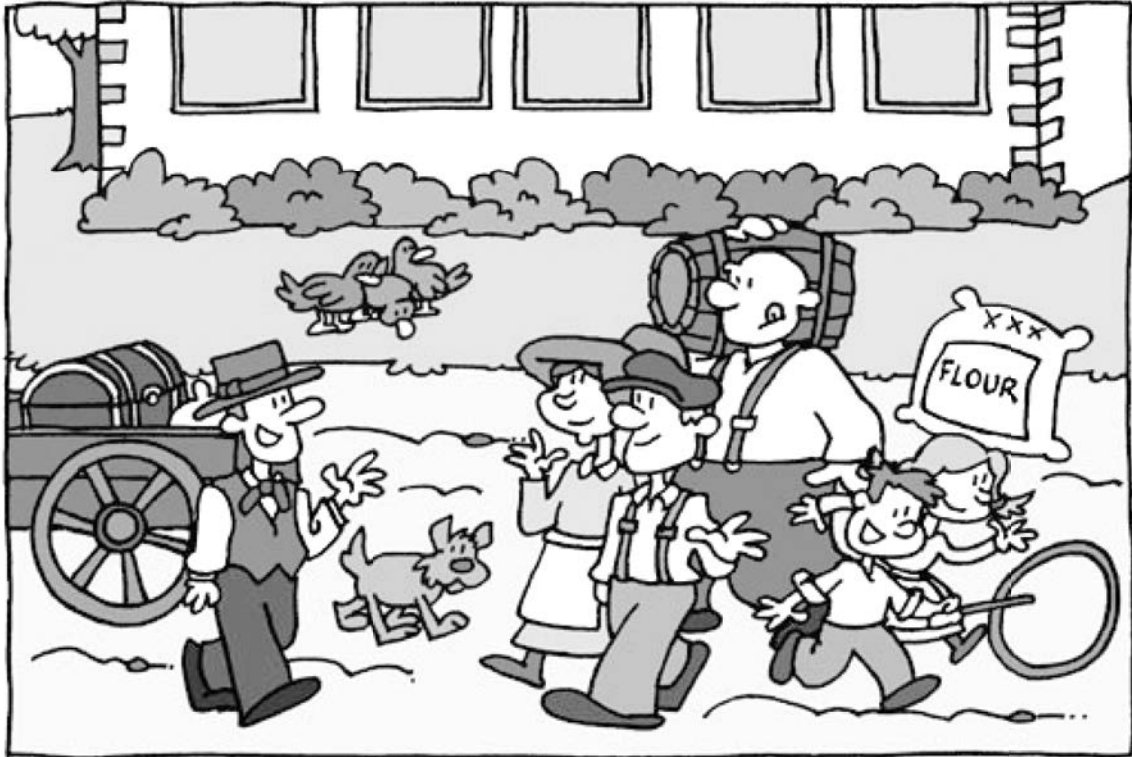

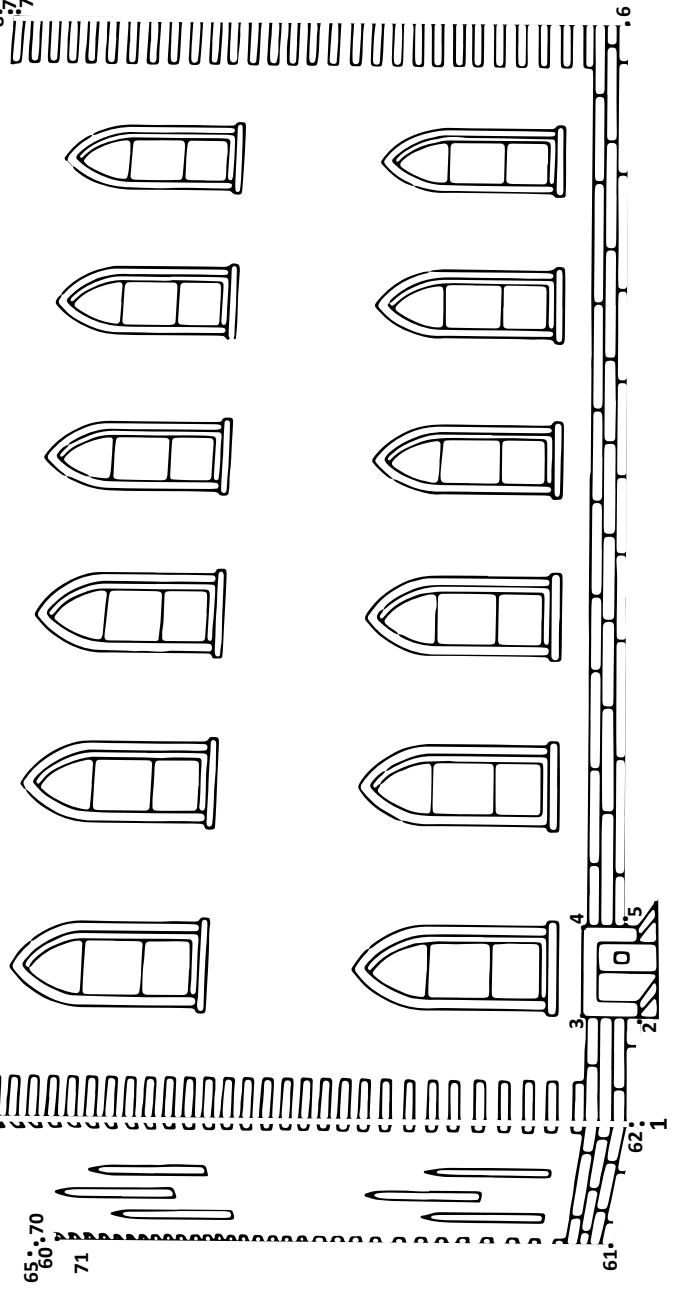
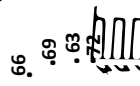
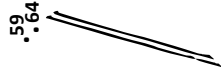
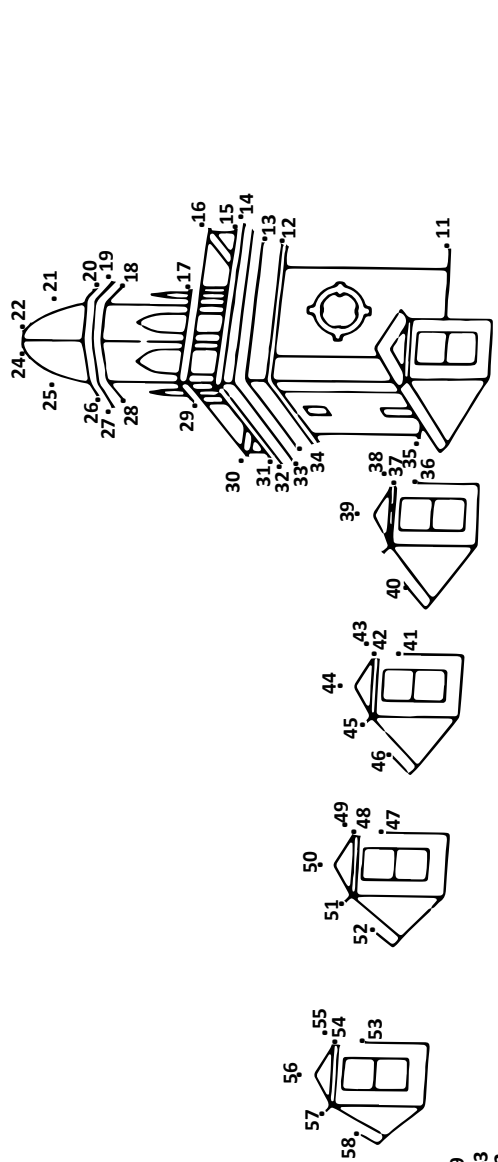
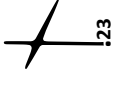

Turning Our Hearts

The Savior wants us to turn our hearts to our ancestors. Can you help these children through the maze so they can find their grandparents?

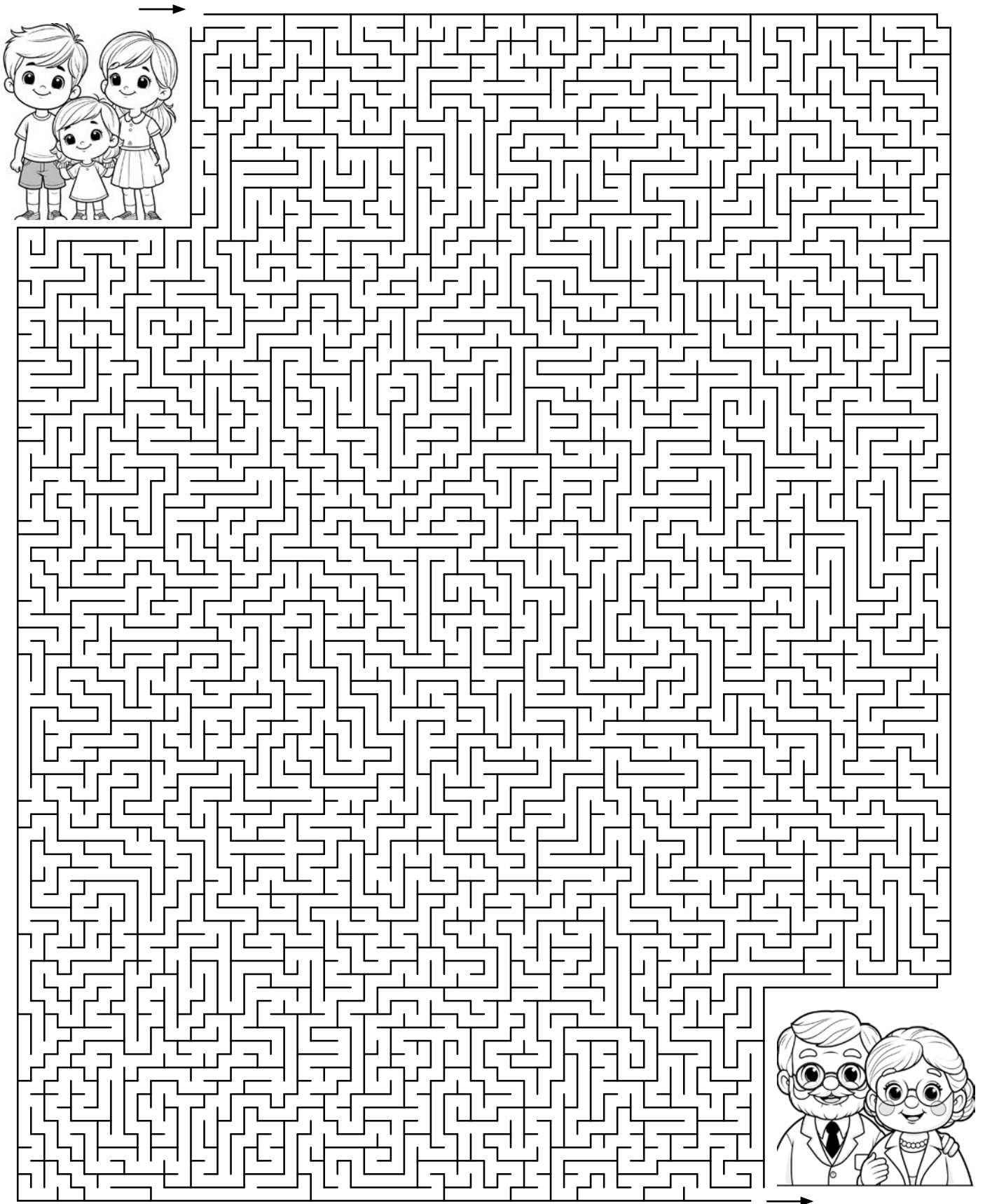

September 29–October 5

Doctrine and Covenants 109–110

“It Is Thy House, a Place of Thy Holiness”

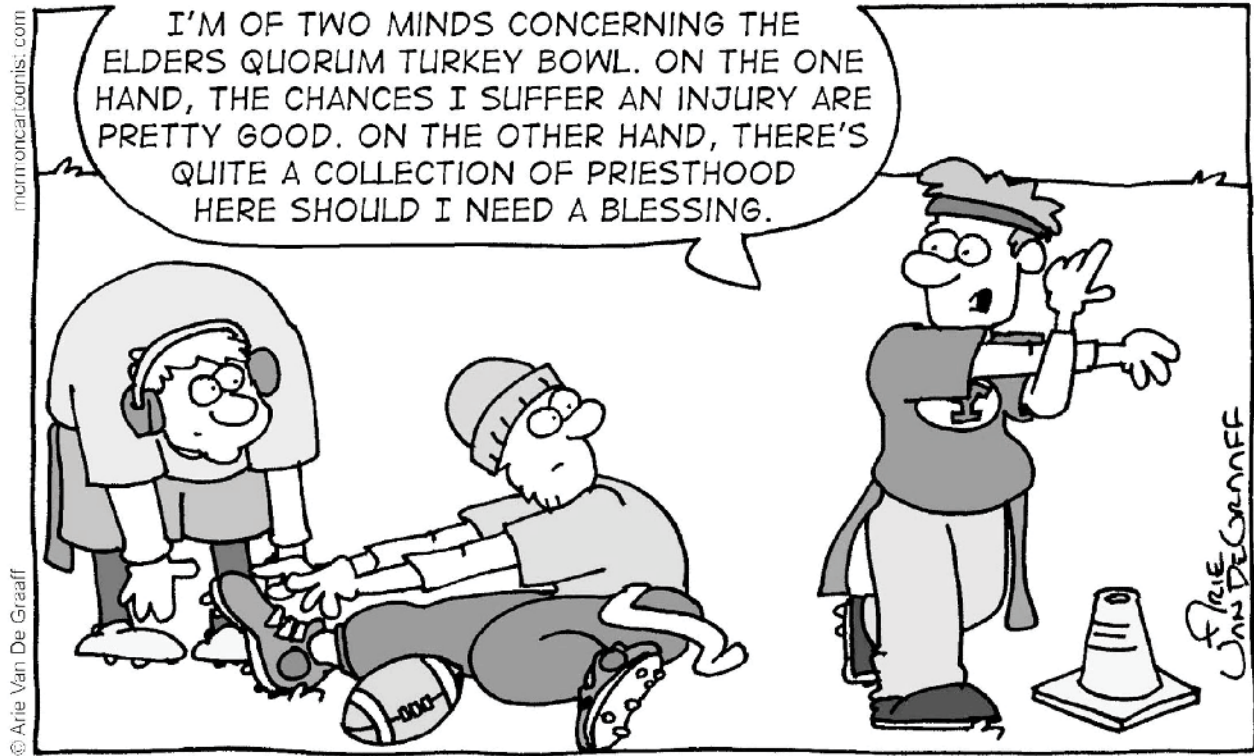

Letterbox Puzzle

Instructions: Find the hidden word in the puzzle below by crossing out all letters that occur twice or more. Capitalized and lowercase letters count as unique letters for this puzzle. The letters left over will form a word. Write down the left over letters like you would read a book, from left to right and top to bottom. Then find the hidden word in the scripture or phrase below and circle it.

Doctrine and Covenants 109:12–13

That thy glory may rest down upon thy people, and upon this thy house, which we now dedicate to thee, that it may be sanctified and consecrated to be holy, and that thy holy presence may be continually in this house; And that all people who shall enter upon the threshold of the Lord's house may feel thy power, and feel constrained to acknowledge that thou hast sanctified it, and that it is thy house, a place of thy holiness.

Write the hidden word:

B	H	O	g	x	Z
m	y	y	a	g	t
m	u	J	b	Z	P
j	S	a	J	s	T
P	j	x	T	S	q
B	b	q	t	m	E

Hidden Picture: The things of God can be a treasure to us. Look and find 3 pictures each of the things the Lord treasures in the hidden picture below. It will be tricky; the pictures may be smaller, on their side, or even upside down! Then, see if you can find one copy of the animals as well.

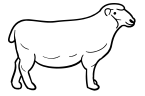
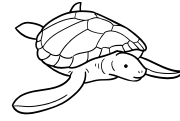

October 6–12

Doctrine and Covenants 111–114

“I Will Order All Things for Your Good”

Word Search

Instructions: Find the bold words from the scripture in the word search puzzle. Each word could be hidden forwards, backwards, up, down, or diagonally.

Doctrine and Covenants 112:24–26

Behold, **vengeance** cometh **speedily** upon the **inhabitants** of the **earth**, a **day** of **wrath**, a day of **burning**, a day of **desolation**, of **weeping**, of **mourning**, and of **lamentation**; and as a **whirlwind** it shall come upon all the **face** of the **earth**, saith the Lord. And upon my **house** shall it **begin**, and from my house shall it go **forth**, saith the Lord; **First** among those among you, saith the Lord, who have **professed** to **know** my **name** and have **not** known me, and have **blasphemed** **against** me in the **midst** of my house, saith the Lord.

D	G	P	O	D	E	S	O	L	A	T	I	O	N	P
N	N	G	N	I	P	E	E	W	P	T	S	Y	A	D
I	I	P	H	Z	Z	C	E	R	D	F	S	D	L	H
W	N	E	T	M	L	A	O	E	S	Y	O	R	I	U
L	R	T	R	U	B	F	M	D	S	B	H	R	I	M
R	U	P	A	O	E	E	X	E	U	Y	Y	G	T	F
I	O	S	E	S	H	U	N	R	A	E	Y	M	F	H
H	M	T	S	P	E	M	N	I	S	B	E	G	I	N
W	V	E	S	M	Y	I	P	U	K	W	T	N	H	H
Z	D	A	A	S	N	P	O	Y	Y	O	K	O	T	T
K	L	N	B	G	G	H	C	M	W	N	Z	T	R	A
B	V	E	N	G	E	A	N	C	E	K	Z	S	A	R
N	O	I	T	A	T	N	E	M	A	L	K	A	E	W
A	G	A	I	N	S	T	Y	L	I	D	E	E	P	S
A	Y	S	S	T	N	A	T	I	B	A	H	N	I	M

Word Guess

Instructions: Write your word guesses in the puzzle below. For extra hints, look at the words/phrases in the scripture below. Check the answer on ColorMeChristian.org

	I	L				T	E	
						T	E	M
			M	Y		H		
	C				U	A		O
C		V						

Doctrine and Covenants 112:13–14

And after their temptations, and much tribulation, behold, I, the Lord, will feel after them, and if they harden not their hearts, and stiffen not their necks against me, they shall be converted, and I will heal them. Now, I say unto you, and what I say unto you, I say unto all the Twelve: Arise and gird up your loins, take up your cross, follow me, and feed my sheep.

Instructions: Connect all of the letters in the maze and then write the phrase in the blanks below. Don't be tricked by letters that take you into a dead end! There is only one path through the maze.

-----, -----
 -----; -----
 -----, -----
 -----, -----.

Moroni 7:13

Start

I	D	O	G	O	D	A	N	D	E	N	T	E	T	O	D	O	G	O	O	D	C	O	N	S	P
G	F	O	F	G	O	H	A	N	I	T	I	C	H	T	O	D	O	G	D	C	O	S	I	N	S
F	O	S	G	O	D	T	H	D	C	I	C	E	T	O	D	O	G	O	O	D	C	I	S	I	N
O	S	I	I	D	T	E	T	E	N	T	E	T	H	D	O	G	O	C	O	N	T	M	I	S	I
H	I	H	N	I	I	T	E	I	T	H	T	O	D	O	G	O	O	D	H	E	H	I	M	I	S
E	B	C	H	N	V	E	W	O	O	T	H	T	O	D	O	G	O	O	S	V	E	H	I	S	I
B	T	I	H	V	I	A	T	O	G	O	T	O	O	D	A	N	D	T	O	R	H	I	M	I	N
U	T	B	E	H	O	L	D	O	O	L	O	V	E	G	O	D	A	N	O	S	V	E	H	I	S
T	B	E	H	O	L	D	D	O	T	O	V	E	G	A	D	A	N	D	T	O	R	V	E	H	I
B	D	L	O	A	D	T	C	D	D	T	O	G	O	T	A	N	D	T	O	S	E	R	V	I	M
E	T	L	A	U	N	I	O	C	N	D	L	E	S	D	N	D	T	V	S	S	I	N	S	P	I
H	Y	L	L	A	I	T	N	O	A	D	A	R	E	T	O	S	E	R	M	I	S	I	N	S	P
R	E	H	W	L	N	I	N	N	D	O	O	E	S	O	R	V	E	V	I	M	I	S	I	P	I
T	Y	T	Y	L	U	N	G	O	D	O	G	O	E	S	E	R	V	E	H	I	M	I	N	S	P
Y	R	Y	L	L	A	U	O	T	O	D	O	O	R	E	R	V	E	H	I	M	I	S	I	N	I
R	E	R	Y	L	L	A	T	H	D	I	G	I	M	R	H	E	H	I	N	S	P	I	N	S	R
E	V	E	W	Y	L	L	L	T	H	S	I	M	I	V	E	H	I	M	I	P	I	R	E	D	E
V	E	E	R	E	Y	L	Y	E	S	I	M	I	H	E	H	I	M	I	S	I	R	E	D	G	O
E	E	R	O	H	W	Y	E	C	E	S	I	M	I	H	I	M	I	N	I	R	E	D	O	F	D
E	R	O	F	E	H	W	C	I	P	I	P	I	M	I	M	I	S	S	P	E	D	O	F	G	B
R	O	F	E	R	E	H	I	T	S	N	S	P	I	R	E	D	I	N	I	D	O	F	G	O	U
E	R	O	F	E	R	E	E	N	P	S	P	I	R	E	F	G	O	D	B	U	T	D	O	D	T
E	E	R	O	R	D	N	D	E	I	P	I	R	E	D	O	F	G	O	D	B	U	T	B	E	H
V	E	I	T	N	E	A	E	E	R	I	D	E	D	O	F	G	O	B	E	H	O	L	E	H	H
E	T	H	I	T	N	H	A	D	E	R	E	D	O	F	G	O	U	T	B	E	H	O	L	D	T
R	Y	T	H	A	H	T	H	D	O	E	O	G	F	G	O	D	B	U	T	B	E	H	O	T	H
Y	T	N	D	H	T	E	T	H	G	D	O	F	G	O	D	B	U	T	B	E	L	O	L	D	A
T	N	A	H	T	E	T	E	G	F	O	F	G	O	D	B	U	T	B	E	H	O	L	C	H	I
H	A	H	T	E	T	I	T	O	G	F	G	O	H	O	U	T	B	E	H	T	W	H	I	C	H
I	N	C	H	T	E	V	I	T	O	G	O	H	E	H	O	L	D	T	H	A	T	W	H	I	I
N	G	I	C	H	V	N	V	I	T	O	D	E	B	E	H	O	L	D	T	H	A	T	I	C	H
G	W	H	I	C	H	I	N	V	B	D	B	U	T	B	E	H	O	L	D	T	H	W	C	H	I

Finish

October 6–12

Doctrine and Covenants 111–114

“I Will Order All Things for Your Good”



Handwriting Practice

Practice your handwriting by tracing the sentence below. Then use the blank lines to write the sentence on your own.

Jesus wants me to love everyone.

October 6–12

Doctrine and Covenants 111–114

“I Will Order All Things for Your Good”

Word Sudoku

Instructions: Solve this word sudoku puzzle the same way that you’d solve a numeric sudoku. Each of the bold words in the scripture below is found once in every row, column and 3×3 box.

Doctrine and Covenants 111:2, 10–11

I have much **treasure** in this **city** for you, for the **benefit** of **Zion**, and many **people** in this city, whom I will **gather** out in due **time** for the benefit of Zion, through your instrumentality.... For there are more treasures than one for you in this city. Therefore, be ye as wise as serpents and yet without sin; and I will **order** all things for your **good**, as fast as ye are able to receive them. Amen.

benefit						Zion	order	
city	people	order	good					
treasure		time			benefit	city		
		city	people		time			Zion
good	time	gather						benefit
people					order	time	treasure	
gather	order		benefit					time
time				Zion	people			order
Zion		people	time			treasure		

October 13–19

Doctrine and Covenants 115–120

“His Sacrifice Shall Be More Sacred unto Me Than His Increase”

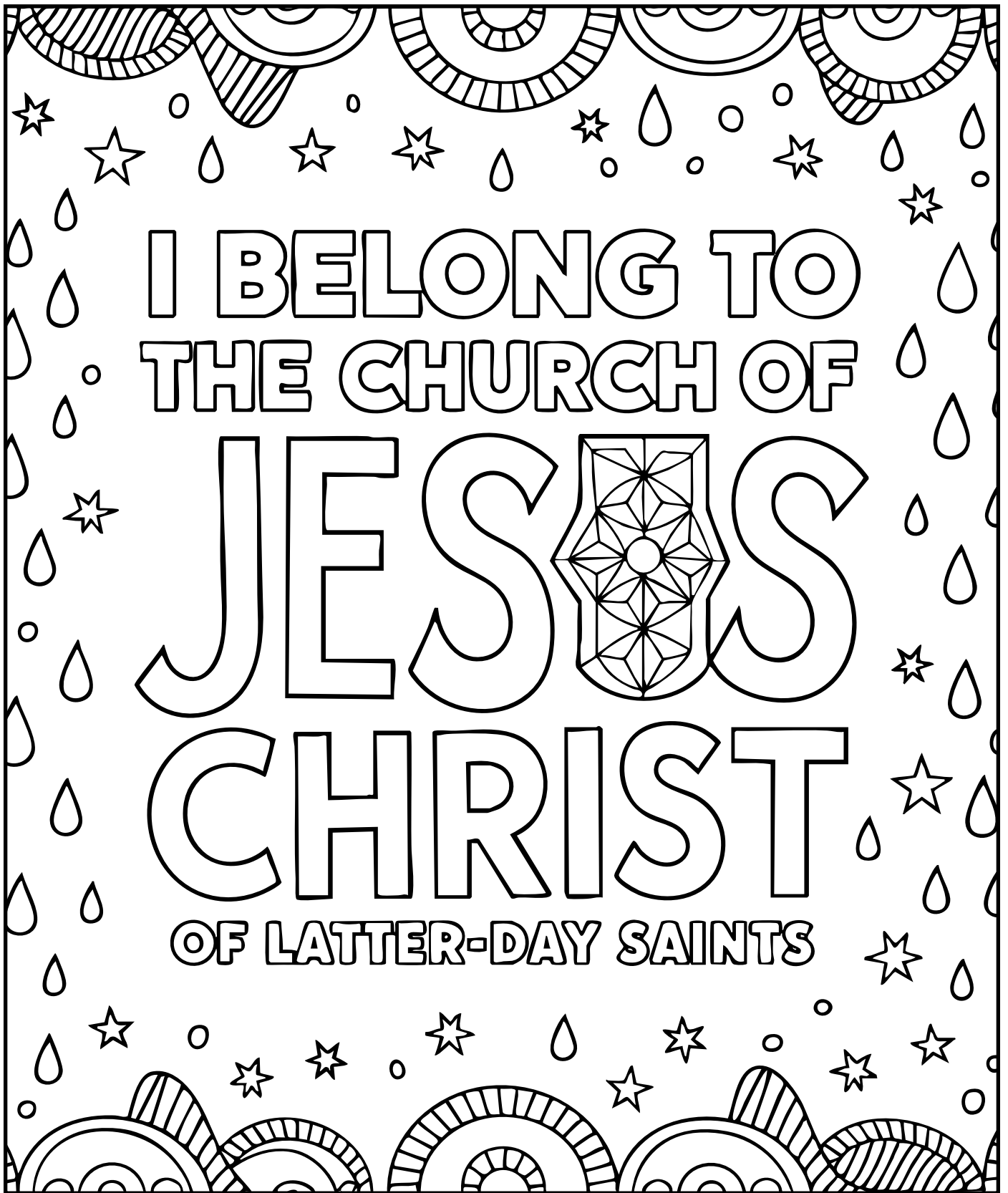

I BELONG TO
THE CHURCH OF
JESUS
CHRIST
OF LATTER-DAY SAINTS

October 13–19

Doctrine and Covenants 115–120

“His Sacrifice Shall Be More Sacred unto Me Than His Increase”

Missing Vowels Word Search

Instructions: Find the hidden words. The words have been placed horizontally, vertically, diagonally, forwards, or backwards, and the vowels have been removed. When you locate a word, draw an ellipse around it and fill the vowels in.

Doctrine and Covenants 117:2-4,6

Let them **awake**, and **arise**, and **come** forth, and **not tarry**, for I, the Lord, **command** it. Therefore, if they tarry it shall not be well with them. Let them **repent** of all their **sins**, and of all their **covetous desires**, before me, saith the Lord; for **what** is **property** unto me? saith the Lord.... For have I not the **fowls** of **heaven**, and also the **fish** of the **sea**, and the **beasts** of the **mountains**? Have I not **made** the **earth**? Do I not hold the **destinies** of all the **armies** of the **nations** of the earth?

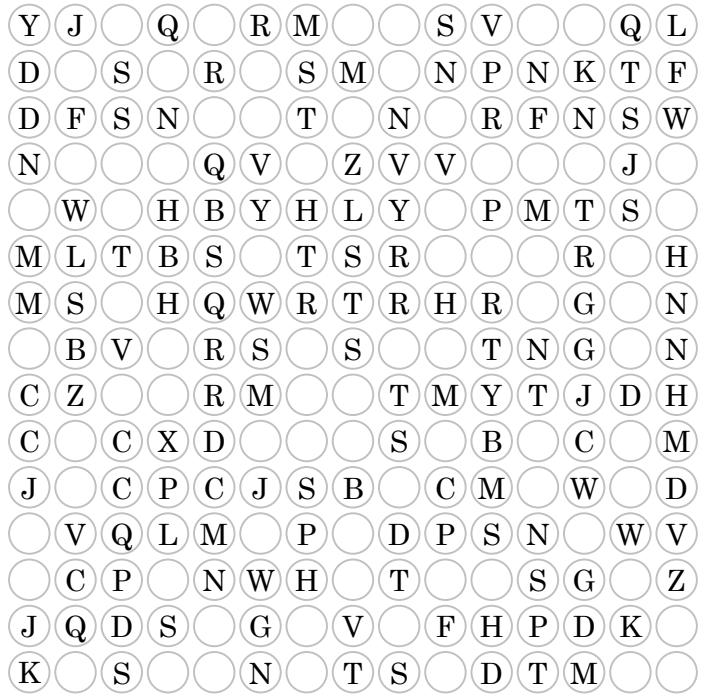

Word Star

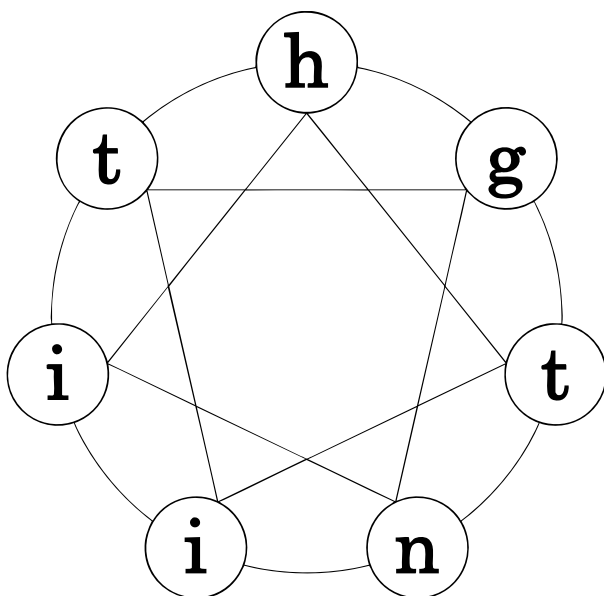

Instructions: Only one route through the word star will make a word. Try each letter and follow the pathway through the star to see if it makes a word.. IF you need a hint, look at the words in the scripture below. Write the letters of the word you discover in the blanks below as you travel through the star:

— — — — —

Now can you find this word in the following scripture?

Doctrine and Covenants 119:2-3

October 13–19

Doctrine and Covenants 115–120

“His Sacrifice Shall Be More Sacred unto Me Than His Increase”

Word Spiral

Instructions: Fill in the blank puzzle grid using the bold words from the scripture or phrase below. *The bold words may not all be used!* Use the letter hint below and count the letters of the bold words to figure out where each word goes. Then transfer the letters that have little numbers in their box to the hidden word at the bottom of the puzzle. Check the answer on ColorMeChristian.org.

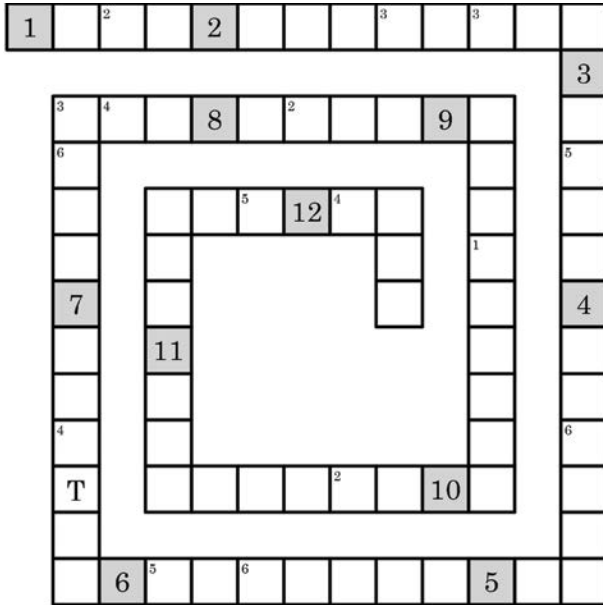

Doctrine and Covenants 119-5-7

Verily I say unto you, it shall come to pass that all those who **gather** unto the land of **Zion** shall be **tithed** of their **surplus** properties, and shall **observe** this **law**, or they shall not be **found worthy** to **abide** among you. And I say unto you, if my people observe not this law, to keep it **holy**, and by this law **sanctify** the **land** of Zion unto me, that my **statutes** and my **judgments** may be **kept** thereon, that it may be most holy, behold, verily I say unto you, it shall not be a land of Zion unto you. And this shall be an ensample unto all the stakes of Zion. Even so. Amen.

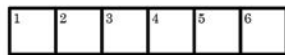

Unscrambler

Instructions: Unscramble the words below; look at the bold words in the scripture for a hint.

Doctrine and Covenants 117:8-9

Is there not **room** enough on the **mountains** of Adam-ondi-Ahman, and on the plains of **Olah** **Shinehah**, or the land where Adam **dwelt**, that you should **covet** that which is but the **drop**, and neglect the more **weighty matters**? Therefore, come up **hither** unto the **land** of my people, even **Zion**.

dnla _____

teihhr _____

iygwthe _____

moro _____

soimatunn _____

inzo _____

loaah _____

stream _____

eldtw _____

cvoet _____

hhhianse _____

odrp _____

October 13–19

Doctrine and Covenants 115–120

“His Sacrifice Shall Be More Sacred unto Me Than His Increase”

My sacrifices are sacred to the Lord.

Come, Follow Me 2025 Manual

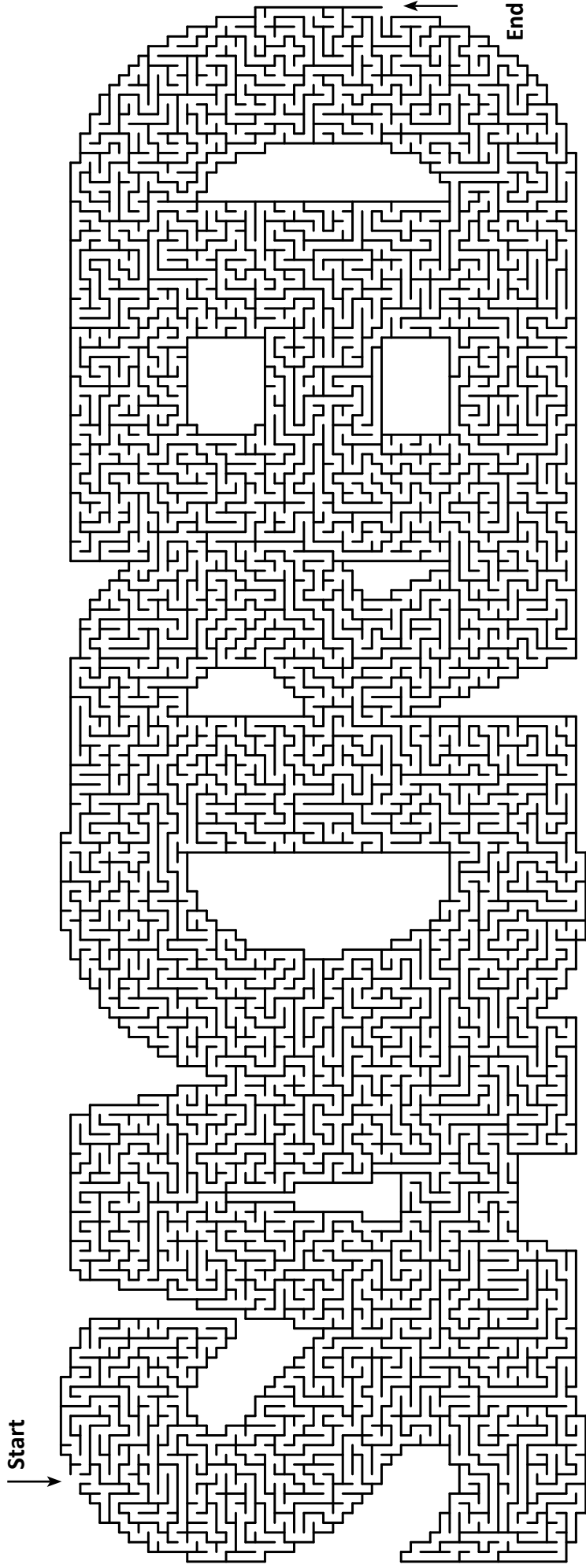

October 13–19

Doctrine and Covenants 115–120

“His Sacrifice Shall Be More Sacred unto Me Than His Increase”

Translation Station

Instructions: Translate the Morse code below into English to discover the hidden message. Write the alphabet letter beneath each Morse Code letter. Each letter, number, and punctuation is separated by a slash: /. Use the key at the back of the book to help you.

...-/./.-././.-.../-...- / .. / .../.-/-...- /
 ...-/-./-/-...- / -...-/-...-/.- / .-/.-.../.-.../-...- /
 .-/.-.../.-.../.- / .-/-./-... / .../.-.../.-...- /
 .-.../-...-/.-...- / -...- / -...- / -...- / -...- /
 .-.../.-...- / -...- / -...- / -...- / -...- /
 ...- / -...- / -...- / -...- / -...- / -...- / -...- /
 .- / -...- / -...- / -...- / -...- / -...- / -...- /
 .- / -...- / -...- / -...- / -...- / -...- / -...- /
 .-...- / -...- / -...- / -...- / -...- /

Word Square

Instructions: Word squares are a liike Sudoku puzzles, but each letter can occur only once in each row and in each column. Check your puzzle against the answer key on ColorMeChristian.org. Every row and column must contain every letter in the word **STORM**. This word can be written in the gray row.

Doctrine and Covenants 115:6

And that the gathering together upon the land of Zion, and upon her stakes, may be for a defense, and for a refuge from the **storm**, and from wrath when it shall be poured out without mixture upon the whole earth.

			O	R
	M	S		
	O		M	
O				T

October 13–19

Doctrine and Covenants 115–120

“His Sacrifice Shall Be More Sacred unto Me Than His Increase”



Handwriting Practice

Practice your handwriting by tracing the sentence below. Then use the blank lines to write the sentence on your own.

My sacrifices are sacred to the Lord.

Blank handwriting practice lines for independent writing.

October 20–26

Doctrine and Covenants 121–123

“O God, Where Art Thou?”

Letter Sudoku

Instructions: Solve the letter sudoku puzzle the same way you’d solve a numeric sudoku. Check your puzzle against the answer key on ColorMeChristian.org. Every column, row, and group of nine must contain every letter in the word(s) **THIS WORLD**.

Doctrine and Covenants 121:34–35

Behold, there are many called, but few are chosen. And why are they not chosen? Because their hearts are set so much upon the things of **this world**, and aspire to the honors of men, that they do not learn this one lesson— That the rights of the priesthood are inseparably connected with the powers of heaven, and that the powers of heaven cannot be controlled nor handled only upon the principles of righteousness.

R								
		S	D	R			W	O
		H			T			R
W	T			H				
				L			R	
H	D		I	W	S		T	L
I	H	T			L		S	
					H		O	T
L		O						I



My son, peace be unto thy soul; thine adversity and thine afflictions shall be but a small moment; And then, if thou endure it well, God shall exalt thee on high; thou shalt triumph over all thy foes. (Doctrine and Covenants 121:7-8)

October 20–26

Doctrine and Covenants 121–123

“O God, Where Art Thou?”

Wacky Word Trails

Instructions: Start with the circled letter, use the clues to find and mark the trail of letters of all the connected bolded words from the scripture through the maze to the last letter. The path can wander up, down, left, and right at any point, even in the middle of the word.

Doctrine and Covenants 121:41-44

No **power** or **influence** can or ought to be **maintained** by virtue of the **priesthood**, only by **persuasion**, by long-suffering, by **gentleness** and **meekness**, and by **love unfeigned**; By **kindness**, and pure **knowledge**, which shall greatly enlarge the soul without hypocrisy, and without guile—**Reproving** betimes with **sharpness**, when **moved** upon by the **Holy Ghost**; and then **showing** forth **afterwards** an increase of **love** toward him whom thou hast reproved, lest he esteem thee to be his enemy; That he may know that thy **faithfulness** is **stronger** than the **cords of death**.

G	G	D	I	G	N	E	H	Z	O	O	D	J	M	G	P	N	Z	L
L	O	Y	E	F	J	D	P	P	H	L	C	O	Z	J	J	B	P	Q
K	E	E	M	N	E	V	R	S	T	G	E	R	D	I	X	U	V	X
N	R	D	S	U	D	O	I	E	V	Y	G	I	S	C	Z	W	P	I
E	A	W	R	F	A	M	E	H	U	L	J	N	U	E	N	F	T	X
S	S	P	E	T	L	O	V	U	Z	O	A	F	L	E	C	J	H	E
B	W	O	S	T	E	O	E	R	N	B	V	B	O	M	T	Q	E	M
F	E	R	O	R	G	L	Y	M	A	D	R	P	X	S	K	W	I	K
I	J	G	H	E	D	U	M	P	R	X	R	D	N	I	X	H	J	N
M	V	O	R	P	E	L	G	O	H	S	G	N	S	K	E	L	Z	P
O	I	P	L	P	O	W	O	W	I	S	S	E	S	E	N	T	N	P
N	N	G	R	S	S	I	N	K	N	G	D	J	E	M	S	G	E	M
Q	M	P	E	U	A	O	N	H	T	A	E	H	Q	T	S	E	L	S
E	R	A	M	R	N	O	S	H	B	N	O	N	O	R	D	N	M	Q
L	I	I	Y	E	G	R	T	C	V	H	W	V	U	T	G	L	U	F
D	K	N	T	A	I	D	L	O	V	E	E	L	B	L	A	F	A	H
S	U	B	N	B	N	E	H	I	N	H	O	B	X	B	S	S	I	T
Z	Y	K	W	O	B	D	S	J	L	J	L	Y	W	Q	E	N	Y	L
L	E	Q	I	C	L	D	Q	L	S	O	Y	S	H	A	R	P	G	Q

Knight Moves - Find a Word

Instructions: Start with any letter in the puzzle to see if it's the beginning of a word. To get to the second letter, jump two squares in any direction except diagonally, and then one square in a different direction. Your path will look like a capital L. Only one route through the puzzle will make a word. Write the letters of the word you discover in the blanks below as you jump through the squares:

1 2 3 4 5 6 7 8

Now can you find this word in the following scripture?

Doctrine and Covenants 121:1–9

l	n	v
a		i
o	i	p

Mystery Picture Graph

Instructions: Find the mystery picture below by plotting and connecting the points of each line on the coordinate graph. Connect all the points in Line 1, stop, pick up your pencil, and then connect all the points in Line 2, and so on for the rest of the lines. The dot for the first (X,Y) coordinate pair on Line 1 has been placed for you.

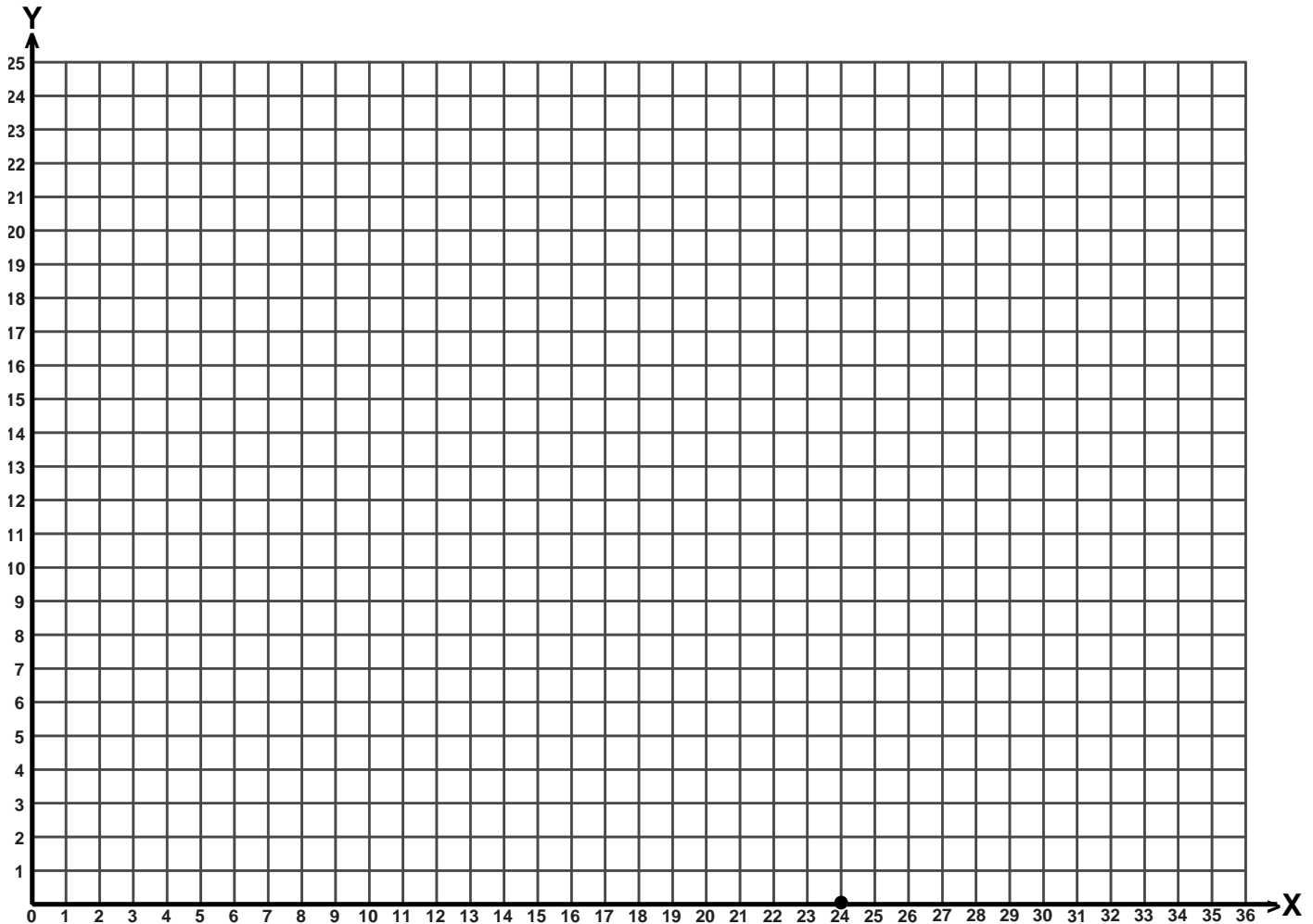

Line 1	(24, 0)	(30, 0)	(30, 2)	(29, 2)	(29, 1)	(24, 1)	(24, 2)	(6, 2)	(6, 4)	(3, 4)	(3, 7)	(8, 7)
(8, 4)	(29, 4)	Line 2	(5, 7)	(5, 10)	(8, 10)	(8, 7)	Line 3	(8, 10)	(8, 21)	(7, 21)	(7, 24)	(29, 24)
(29, 21)	(8, 21)	Line 4	(8, 20)	(2, 20)	(2, 18)	(8, 18)	Line 5	(5, 18)	(5, 16)	(0, 16)	(0, 18)	(2, 18)
Line 6	(11, 21)	(11, 4)	Line 7	(14, 21)	(14, 4)	Line 8	(17, 21)	(17, 4)	Line 9	(21, 21)	(21, 4)	Line 10
(23, 21)	(23, 4)	Line 11	(26, 21)	(26, 4)	Line 12	(28, 21)	(28, 4)	Line 13	(29, 21)	(32, 21)	(32, 19)	(28, 19)
(28, 16)	(30, 16)	Line 14	(28, 17)	(30, 17)	(30, 19)	Line 15	(30, 16)	(34, 16)	(34, 14)	(28, 14)	Line 16	(31, 14)
(31, 12)	(35, 12)	(35, 14)	(34, 14)	Line 17	(28, 8)	(33, 8)	(33, 5)	(28, 5)	Line 18	(10, 4)	(14, 11)	(15, 11)
(14, 10)	(16, 10)	(16, 7)	(14, 7)	(13, 4)	Line 19	(11, 9)	(14, 11)	(17, 11)	(17, 12)	(15, 13)	(15, 15)	(16, 17)
(15, 18)	(17, 19)	(19, 19)	(21, 17)	(21, 15)	(19, 13)	(20, 12)	(21, 12)	(21, 13)	(22, 12)	(23, 12)	(23, 10)	(27, 6)
(27, 4)	(24, 4)	(21, 9)	(19, 10)	(20, 12)	(18, 14)	(19, 15)	(18, 16)	(17, 15)	(17, 17)	(16, 17)	Line 20	(24, 0)
(24, 1)	Line 21	(29, 4)	(29, 2)	Line 22	(28, 11)	(31, 11)	(31, 12)					

October 20–26

Doctrine and Covenants 121–123

“O God, Where Art Thou?”

Cryptogram

Instructions: Each letter on the top stands for a letter in the alphabet. Solve the encrypted phrase by matching each letter on top to a letter in the alphabet on the bottom. Use the key to help you remember what the letters stand for so you can crack the code.

B	R	Q	J	I	S	V	O	G	F	E	A	K	L	X	U	M	P	W	C	H	Y	N	D	T	Z
A	B	C	D	E	F	G	H	I	J	K	L	M	N	O	P	Q	R	S	T	U	V	W	X	Y	Z

H N H B X I H X L N Q E I U Y V . . . F Y B K Y T U
 J H B Y U Y U V U L W X ; N K Y Y U E W K K V K
 R E K B T K ; N K Y Y U V R L G E N E H W A K
 Y L M K W P R ; N K Y Y U V U E X E W I R N L T K
 W H N H W I K B A K T H G K B K X ; N K Y
 Y U E W K K L B A K E W T N E W K X ; N K Y
 Y U E W K U K L B Y A K F H J Y K W K X , L W X
 Y U V A H S K N F Q H G K X S E Y U
 T H Q R L F F E H W Y H S L B X P F .
 X H T Y B E W K L W X T H G K W L W Y F 1 2 1 : 4

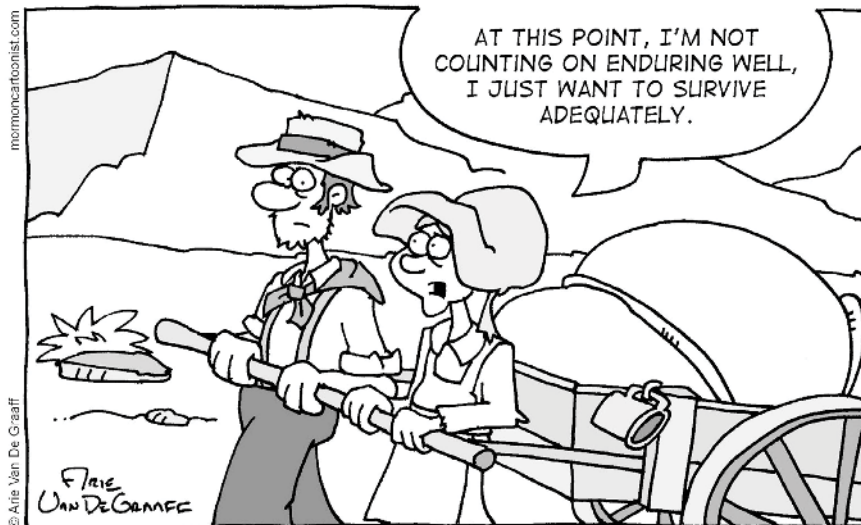

Escape From Liberty Jail

Joseph Smith was unjustly imprisoned in Liberty Jail. Can you help him escape to Nauvoo by traveling through the maze?

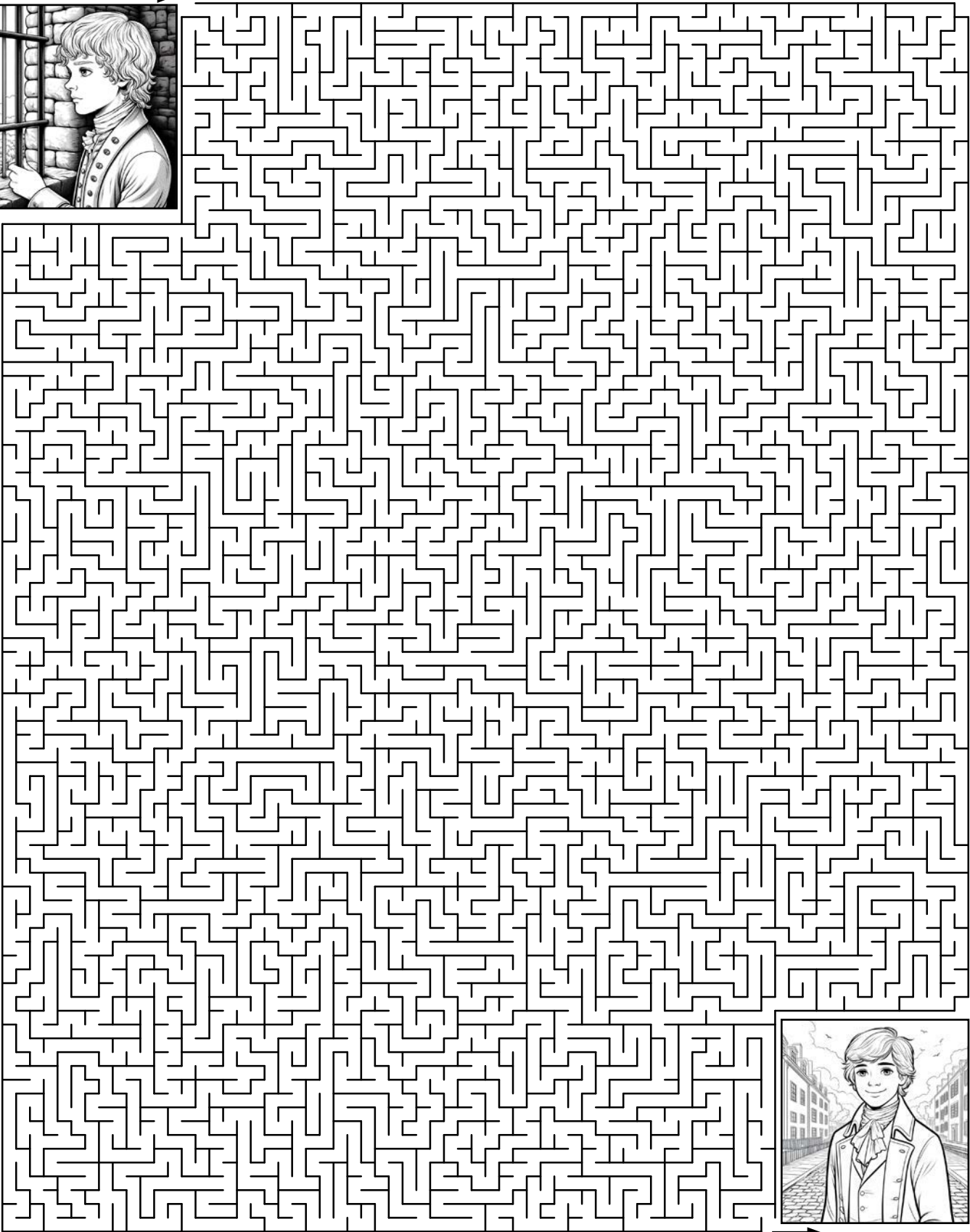

October 20–26

Doctrine and Covenants 121–123

“O God, Where Art Thou?”

Instructions: Fit the bold words from the scripture below into the encircled squares. Words will read forward, backward, up, down, and diagonally and will normally cross other words. Start with the hints provided.

Doctrine and Covenants 122:7–8

And if **thou** shouldst be **cast** into the **pit**, or into the **hands** of **murderers**, and the **sentence** of **death** passed upon thee; if thou be cast into the **deep**; if the **billowing surge conspire** against thee; if **fierce winds** become thine **enemy**; if the **heavens** gather **blackness**, and all the **elements** combine to **hedge** up the way; and above all, if the very **jaws** of **hell** shall **gape** open the **mouth wide** after thee, know thou, my son, that **all these things** shall give thee **experience**, and shall be for thy **good**. The **Son** of **Man** hath **descended below** them all. Art thou **greater** than he?

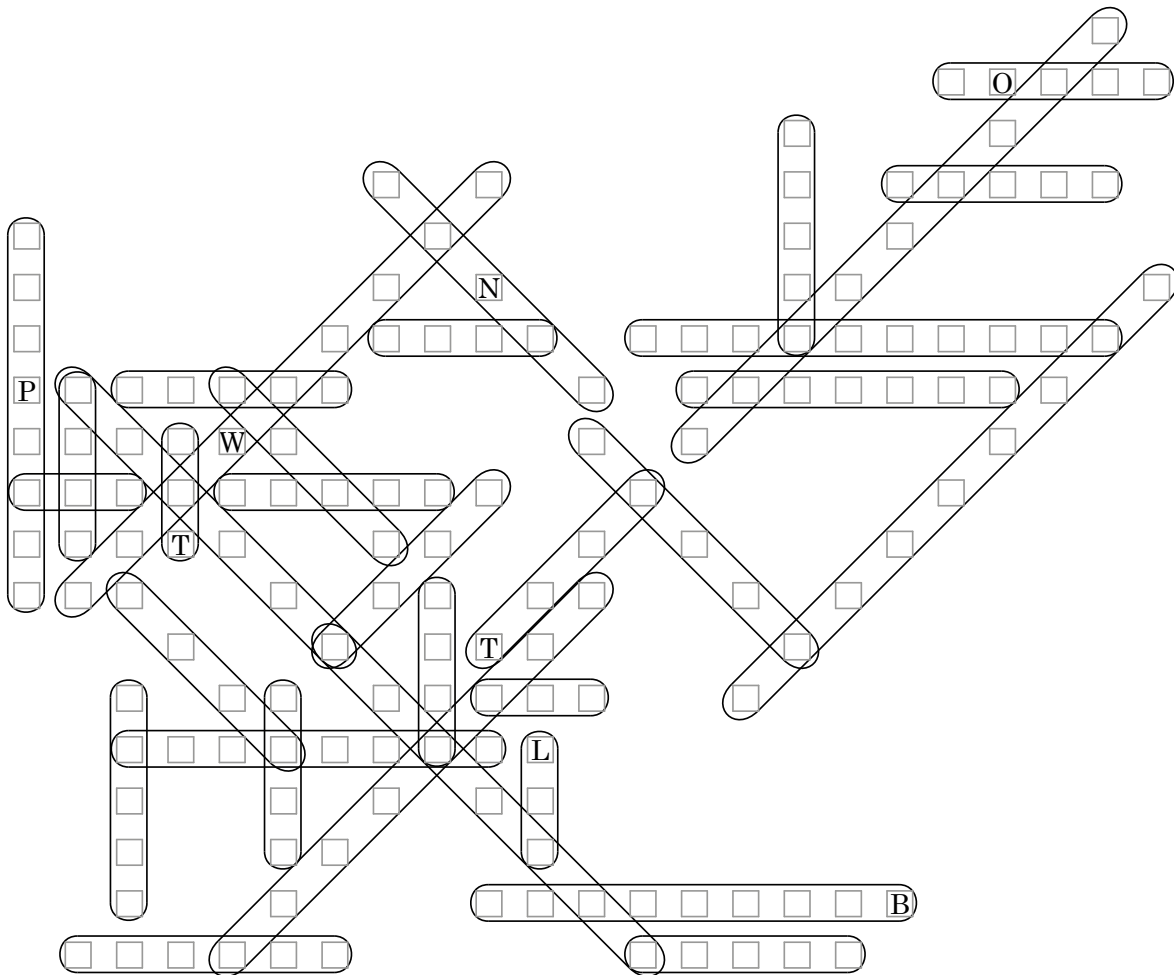

thou	cast	pit	hands	murderers	sentence
death	deep	billowing	surge	conspire	fierce
winds	enemy	heavens	blackness	elements	hedge
jaws	hell	gape	mouth	wide	all
these	things	experience	good	Son	Man
descended	below	greater			

October 27–November 2

Doctrine and Covenants 124

“A House unto My Name”

Word Angles

Instructions: Find the bold words from the scripture. Each word path may run north, east, south, or west, may make one right-angled turn, and may cross another word path. A few words may make no right angle turn at all.

Doctrine and Covenants 124:91–92

And again, verily I say unto you, let my **servant William** be **appointed**, **ordained**, and **anointed**, as **counselor** unto my servant **Joseph**, in the **room** of my servant **Hyrum**, that my servant Hyrum may take the **office** of **Priesthood** and Patriarch, which was **appointed** unto him by his **father**, by **blessing** and also by **right**; That from **henceforth** he shall hold the **keys** of the **patriarchal** blessings upon the **heads** of all my **people**,

R	E	W	A	D	A	I	N	E	D	W	M	W	Z	P	E
N	D	K	B	R	A	E	A	N	O	O	P	P	A	N	I
O	E	E	N	O	C	G	T	P	I	I	H	U	G	Z	M
O	T	Y	S	Q	Q	V	W	A	N	N	E	R	I	K	S
Z	N	U	R	O	L	E	S	G	T	T	N	C	T	G	R
S	I	N	G	C	D	R	N	O	E	E	C	W	H	D	D
S	O	P	P	A	O	D	U	A	D	D	E	W	G	I	R
E	N	T	M	O	O	B	O	S	J	F	F	O	R	T	H
L	A	C	K	O	H	P	C	S	A	L	A	H	C	R	A
B	V	K	Y	R	T	F	I	D	T	H	E	C	I	F	I
M	R	J	S	T	S	U	J	A	T	H	R	Y	H	F	R
A	E	P	R	I	E	Z	C	E	W	M	U	P	E	O	T
C	S	S	E	H	T	A	F	H	I	D	M	I	K	P	A
N	P	Z	U	H	I	C	I	H	L	L	I	A	M	L	P
J	U	V	E	P	E	S	O	J	B	I	I	K	B	E	M
L	K	I	R	H	C	U	S	J	D	P	H	X	X	C	O

Word Guess

Instructions: Write your word guesses in the puzzle below. For extra hints, look at the words/phrases in the scripture below. Check the answer on ColorMeChristian.org

	A	P													T
	E							A	G						
U						F					I	S	T		
P						O	N			O					
H	S					H									D

Doctrine and Covenants 124:28–29

For there is not a place found on earth that he may come to and restore again that which was lost unto you, or which he hath taken away, even the fulness of the priesthood. For a baptismal font there is not upon the earth, that they, my saints, may be baptized for those who are dead—

October 27–November 2

Doctrine and Covenants 124

“A House unto My Name”

Instructions: Using the Across and Down clues, write the correct words in the numbered grid below. Hint: all of the words in the crossword come from the scripture below.

Doctrine and Covenants 124:38–41

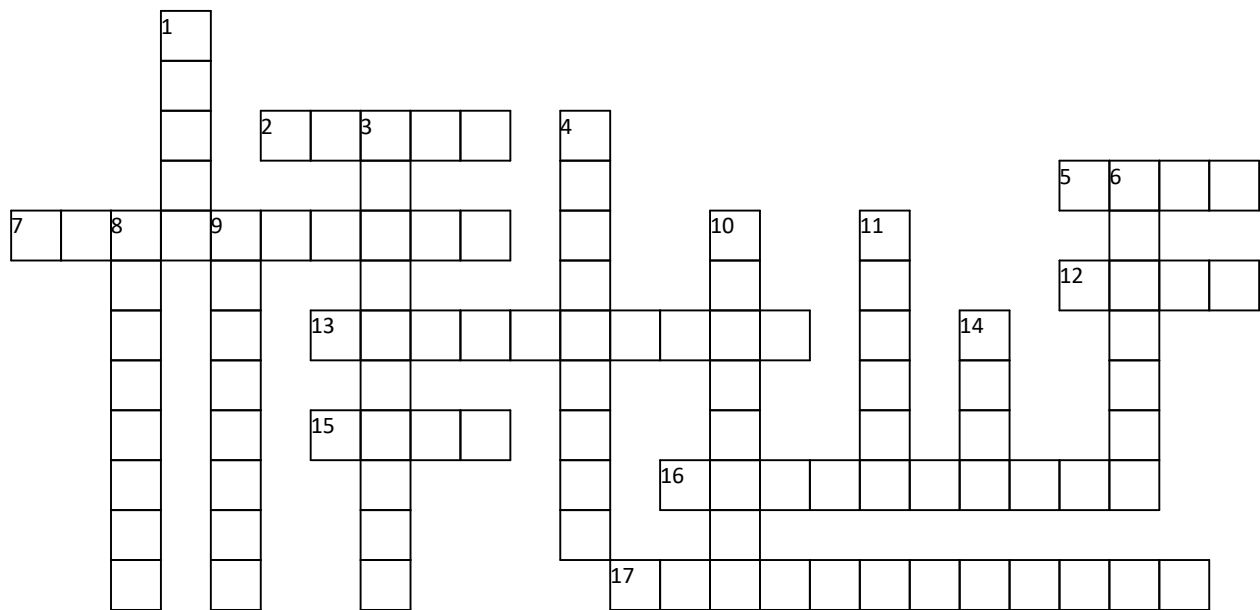

ACROSS

2. A prophet who led the Israelites from Egypt across the Red sea; received the Ten Commandments from God on Mount Sinai
5. dedicated or consecrated to God
7. The center place of Israel's worship activities during the wanderings and until the building of the temple in Solomon's day; a portable temple
12. a language unit by which a person or thing is known
13. a wild and uninhabited area left in its natural condition
15. the pure in heart; also the physical place the pure in heart gather
16. the act of applying oil to the head for a sacred purpose
17. the act of giving out in portions

DOWN

1. a dwelling that serves as living quarters
3. the killing of animals that was a part of the Law of Moses
4. something established to remind one of a person or event
6. a prophet who communicates with God
8. the first ordinance of the gospel; signifies spiritual cleansing and rebirth
9. make visible
10. to clean, most often with water
11. dignified and somber in manner or character
14. the descendants of this son of Jacob were assigned the work of ministering in the temple

1
⊙ 54

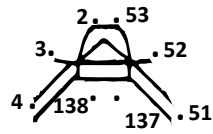

Key

- Stop. Pick up your pencil and go to the next dot.
- ⊙ Start. Put your pencil down and draw the next line.

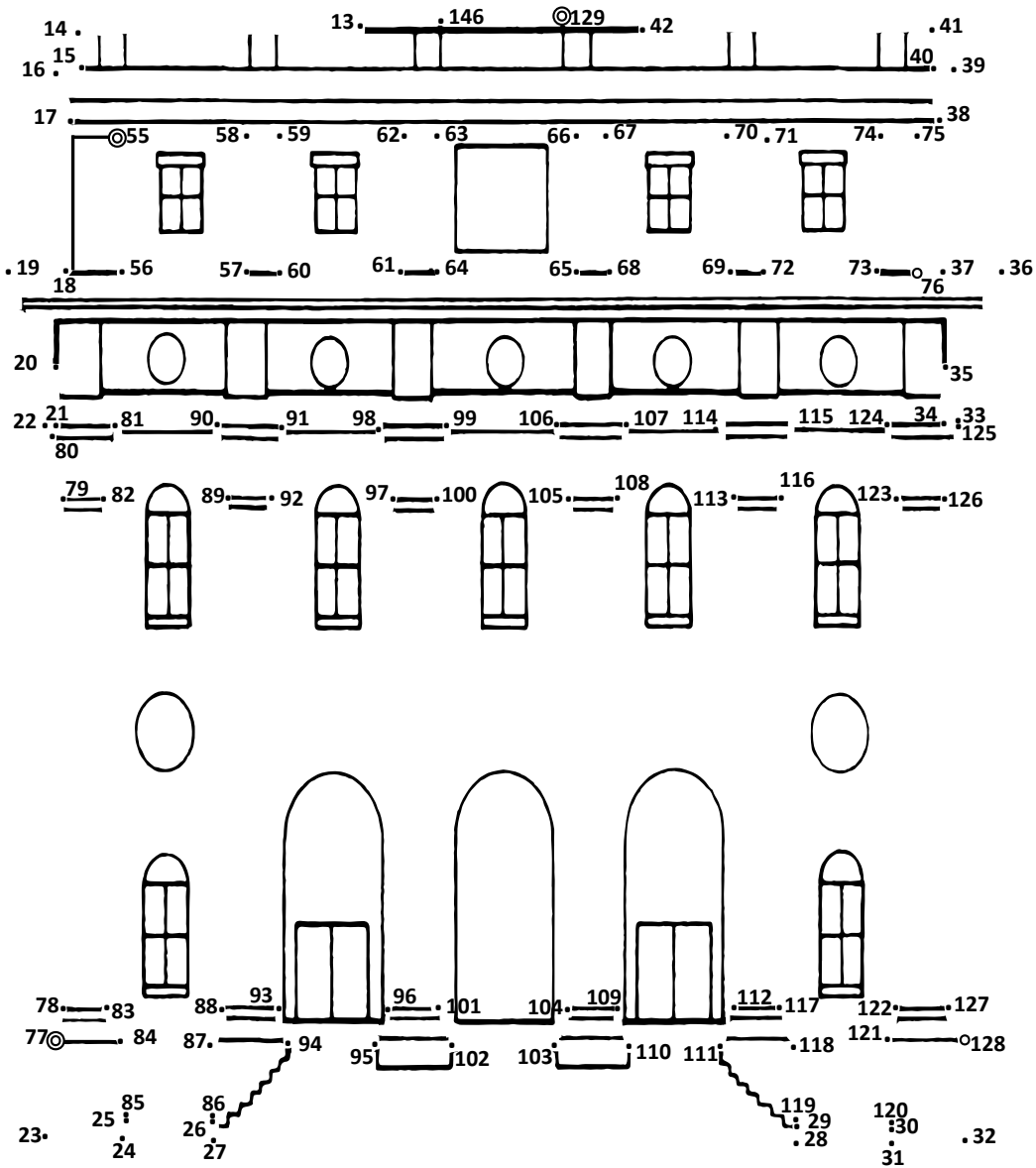
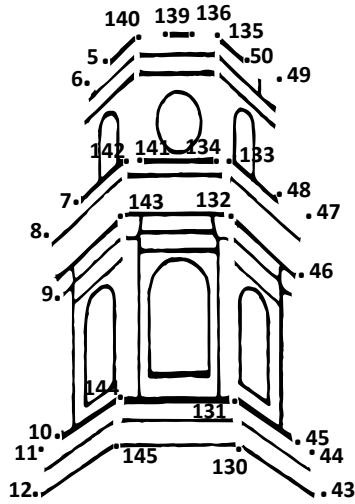

October 27–November 2
Doctrine and Covenants 124
“A House unto My Name”

Handwriting Practice

Practice your handwriting by tracing the sentence below. Then use the blank lines to write the sentence on your own.

Jesus commands His people to build temples.

Letterbox Puzzle

Instructions: Find the hidden word in the puzzle below by crossing out all letters that occur twice or more. Capitalized and lowercase letters count as unique letters for this puzzle. The letters left over will form a word. Write down the left over letters like you would read a book, from left to right and top to bottom. Then find the hidden word in the scripture or phrase below and circle it.

Doctrine and Covenants 124:39

Therefore, verily I say unto you, that your anointings, and your washings, and your baptisms for the dead, and your solemn assemblies, and your memorials for your sacrifices by the sons of Levi, and for your oracles in your most holy places wherein you receive conversations, and your statutes and judgments, for the beginning of the revelations and foundation of Zion, and for the glory, honor, and endowment of all her municipals, are ordained by the ordinance of my holy house, which my people are always commanded to build unto my holy name.

Write the hidden word:

r	S	C	S	q	O
X	I	R	M	q	i
N	m	r	J	f	a
U	I	J	n	d	R
I	j	N	E	Z	X
D	f	Z	i	j	U

October 27–November 2

Doctrine and Covenants 124

“A House unto My Name”



Translation Station

Instructions: Translate the sign language letters below into English to discover the hidden message. Write the alphabet letter beneath each hand sign. Use the key at the back of the book to help you.



















Family Search

By Arie Van De Graaff

Pretend you just heard a family story about someone who joined the Church while at college. They're the first member of the Church in your family! You didn't hear their name, though, so do this activity to find out who it was. Start in the upper left corner and draw a straight line from each two-letter bubble that spells out the phrase "Family History—The Spirit of Elijah." When you're done, look for the one photo that doesn't have a line through it. This is the family member you're looking for!

→ START HERE

FA	RE	LY	PI	AH
 Connor Raines	 Auntie Aubrey	 David Tindall	 Cousin Ellie	
SP	MI	IJ	HI	AM
 Abby Lambert	 Edwin James	 Mary Owens	 Parker Cobbs	
JA	TO	YT	NE	ST
 Cousin Carter	 Kelsey Draper	 Colonel Spencer	 Kristen Hanks	
AV	HE	IT	OR	EL
 Sophie Grace	 Papa Bellamy	 Ava June	 Jake Clyde	
DG	IR	LM	OF	GR

November 3–9

Doctrine and Covenants 125–128

“A Voice of Gladness for the Living and the Dead”

Word Search

Instructions: Find the bold words from the scripture in the word search puzzle. Each word could be hidden forwards, backwards, up, down, or diagonally.

Doctrine and Covenants 128:18

The **earth** will be **smitten** with a **curse** **unless** there is a **welding link** of some kind or other **between** the **fathers** and the **children**, upon some subject or other—and behold what is that subject? It is the **baptism** for the **dead**. For we without them **cannot** be **made perfect**; neither can they without us be made perfect. Neither can they nor we be made perfect without those who have **died** in the **gospel** also; for it is **necessary** in the **ushering** in of the **dispensation** of the **fulness of times**, which dispensation is now **beginning** to usher in, that a **whole** and **complete** and **perfect union**, and welding together of dispensations, and **keys**, and **powers**, and **glories** should take **place**, and be **revealed** from the days of **Adam** even to the **present** time.

P E R F E C T E A M S I T P A B
K T I W R C P S D E L A E V E R
N E C E S S A R Y W U N L E S S
W H O L E T X U E S R E H T A F
N W X D W K C C Q S S E N L U F
O H A I C E B E H A E Q E D P D
I Y S N M Y O E F I D N G A O B
T L K G A S T H G R L A T E W E
A F S O D R G U T I E D M D E T
S I P E E N S N B R N P R E R E
N V K L M O T M I E A N Z E S L
E Y N S F I E O I R T E I F N P
P D I E D N T C N T E W N N A M
S S L E Z U F V A N T H E X G O
I G L O R I E S V L A E S E G C
D L E P S O G P X Y P C N U N X

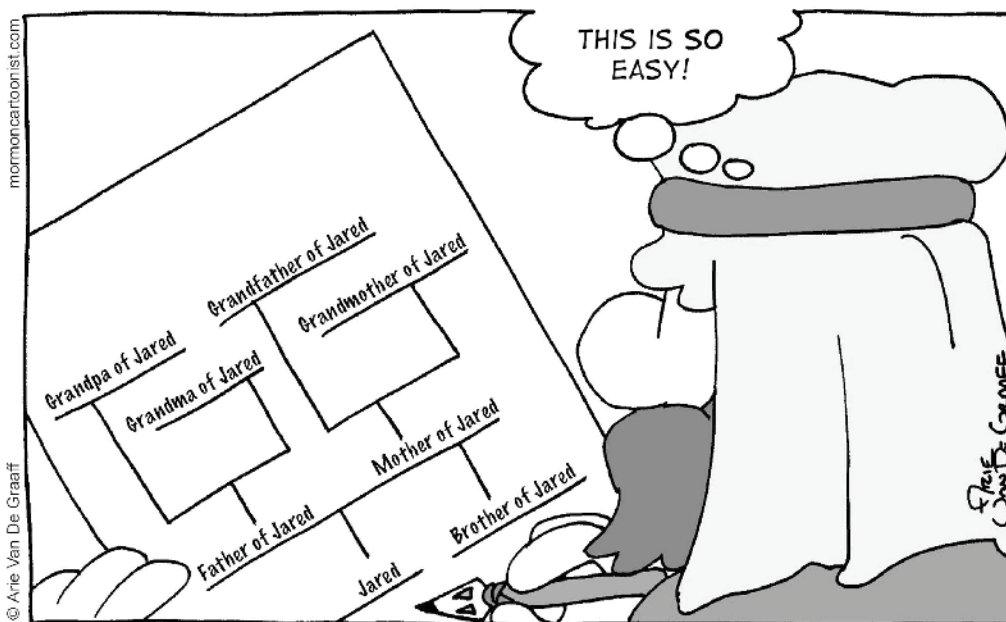

JARED COMPLETES HIS FAMILY GROUP SHEET.

Mystery Picture Graph

Instructions: Find the mystery picture below by plotting and connecting the points of each line on the coordinate graph. Connect all the points in Line 1, stop, pick up your pencil, and then connect all the points in Line 2, and so on for the rest of the lines. The dot for the first (X,Y) coordinate pair on Line 1 has been placed for you.

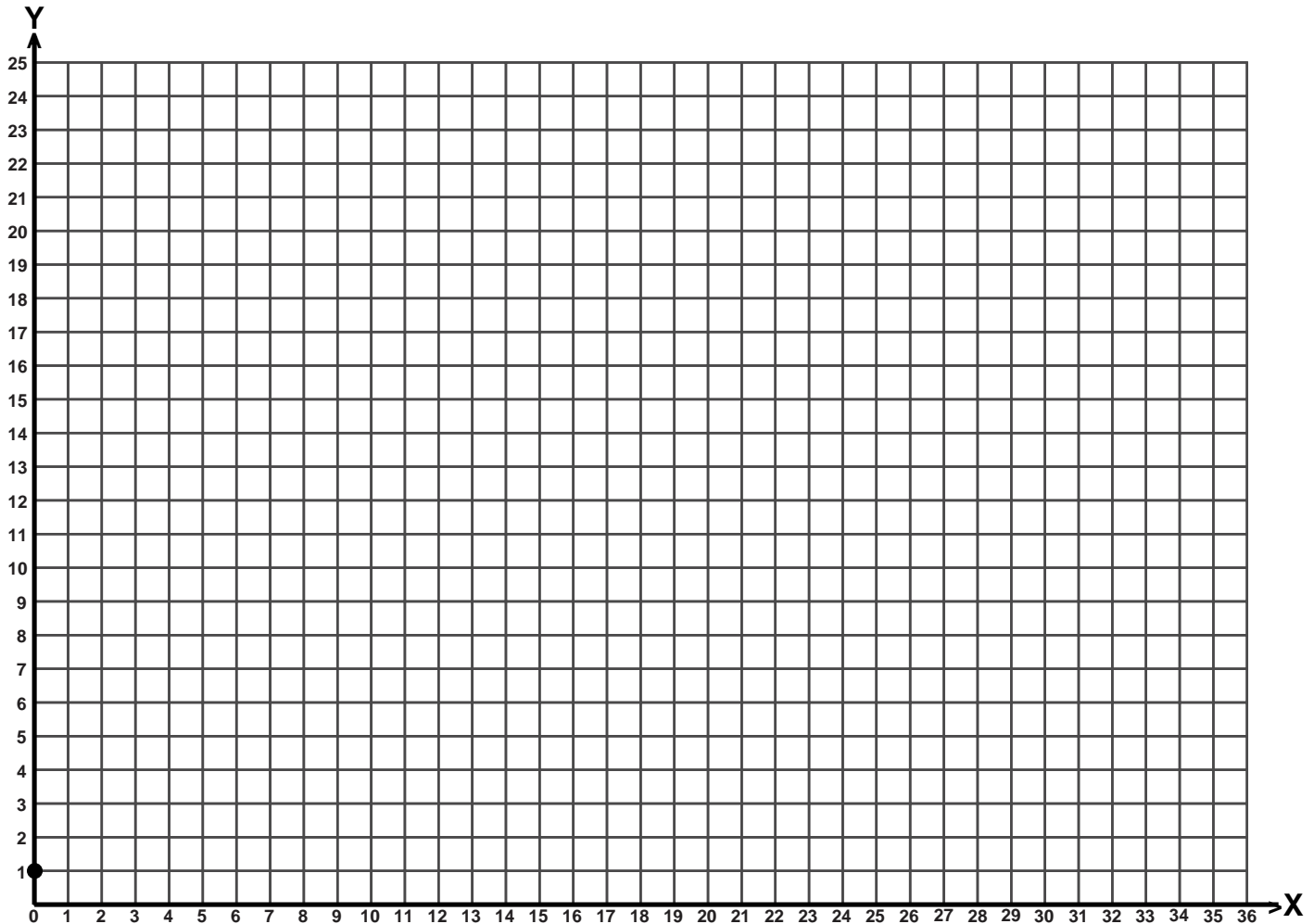

Line 1	(0, 1)	(2, 0)	(5, 1)	(7, 0)	(9, 1)	(11, 0)	(13, 1)	(15, 0)	(17, 1)	(19, 0)	(21, 1)	(24, 0)
(26, 1)	(28, 0)	(30, 1)	(33, 0)	(35, 1)	Line 2	(0, 4)	(2, 3)	(4, 4)	(7, 3)	(9, 4)	(11, 3)	(13, 4)
(15, 3)	(17, 4)	(19, 3)	(21, 4)	(24, 3)	(26, 4)	(28, 3)	(30, 4)	(33, 3)	(35, 4)	Line 3	(7, 3)	(8, 6)
(7, 8)	(7, 13)	(8, 15)	(7, 17)	(8, 19)	(10, 22)	(14, 22)	(14, 17)	(13, 17)	(13, 15)	(15, 13)	(15, 21)	(16, 24)
(17, 24)	(17, 22)	(18, 22)	(17, 20)	(17, 15)	(22, 15)	(22, 16)	(21, 17)	(21, 20)	(23, 22)	(25, 22)	(27, 17)	(27, 15)
(28, 14)	(28, 12)	(26, 8)	(27, 4)	Line 4	(8, 15)	(10, 16)	(13, 10)	(17, 10)	(19, 11)	(19, 10)	(23, 10)	(26, 15)
(24, 15)	(23, 20)	(21, 20)	Line 5	(8, 6)	(10, 5)	(11, 8)	(18, 9)	(24, 8)	(25, 7)	(26, 8)	Line 6	(14, 21)
(10, 16)	(13, 15)	(15, 13)	(16, 13)	(17, 15)	Line 7	(18, 4)	(19, 9)	(18, 9)	(19, 10)	Line 8	(15, 3)	(15, 8)
Line 9	(15, 10)	(15, 13)	(16, 13)	(17, 10)	Line 10	(24, 15)	(22, 15)					

November 3–9

Doctrine and Covenants 125–128

“A Voice of Gladness for the Living and the Dead”

Instructions: Connect all of the letters in the maze and then write the phrase in the blanks below. Don't be tricked by letters that take you into a dead end! There is only one path through the maze.

-----',-----
-----',-----
-----.

Doctrine and Covenants 126:3

Start

M	A	M	A	N	D	F	R	O	M	T	H	I	S	T	I	M	E	H	F	E	H	T	R
M	O	M	M	D	Y	Y	O	M	T	H	I	S	T	I	M	E	H	E	N	C	E	F	O
O	C	O	M	U	O	L	I	M	A	F	R	U	O	Y	F	O	E	R	E	E	N	T	R
R	E	C	O	M	U	T	L	Y	M	A	M	I	L	O	Y	F	O	A	R	E	A	H	T
O	C	O	M	O	T	O	Y	F	I	M	I	L	Y	U	O	R	A	C	A	D	N	A	H
F	O	N	E	S	O	S	E	N	L	Y	L	Y	O	E	R	E	R	L	C	A	R	N	A
E	R	E	M	D	S	E	N	Y	W	F	Y	D	F	R	A	C	L	A	L	R	E	D	N
R	E	F	D	N	E	N	D	M	Y	W	O	R	C	L	A	I	C	I	A	L	E	F	D
E	H	E	R	D	N	D	N	D	T	A	K	E	P	S	C	E	C	I	E	V	O	F	
I	T	H	E	M	D	W	N	A	N	D	T	A	E	E	E	I	P	I	A	R	E	R	O
T	H	O	W	Y	M	Y	A	D	A	N	A	T	A	K	E	P	S	P	R	E	V	E	R
H	E	A	O	W	O	R	O	A	D	A	N	D	T	A	K	S	E	S	C	I	E	V	E
D	A	O	R	O	A	B	R	O	A	D	A	N	D	T	A	K	E	E	E	A	R	E	V
A	O	R	D	R	D	R	O	A	D	A	N	D	T	E	K	E	E	S	P	I	A	R	E
D	A	B	A	B	R	O	A	D	A	N	E	K	A	E	S	E	E	P	E	C	M	A	R
A	O	R	B	R	O	A	D	A	N	D	T	E	K	S	P	S	C	E	C	I	E	M	A
N	A	O	R	O	A	D	D	N	D	T	A	K	E	P	E	P	I	C	T	I	N	E	M
D	D	A	O	A	D	A	T	D	T	A	K	E	E	I	C	L	A	I	H	T	I	T	E
T	A	N	A	D	A	N	A	K	E	E	E	E	L	A	A	C	L	A	E	R	E	I	N
A	N	D	N	A	N	D	T	A	K	E	E	S	P	L	R	A	C	L	R	E	H	T	I
K	S	T	D	N	D	T	A	K	S	P	E	P	E	O	E	R	A	C	E	R	E	H	T
E	E	A	T	D	T	A	E	E	E	S	C	E	Y	F	O	E	R	O	F	E	R	E	H
E	E	K	A	K	A	P	S	E	S	P	I	C	O	Y	F	O	E	R	O	F	E	R	E
S	P	E	K	E	K	E	P	E	C	I	A	I	U	O	Y	F	C	E	R	O	F	E	R
P	S	E	E	E	I	C	E	C	I	C	L	A	R	F	O	Y	O	C	E	R	O	F	E

Finish

November 3–9

Doctrine and Covenants 125–128

“A Voice of Gladness for the Living and the Dead”

Word Sudoku

Instructions: Solve this word sudoku puzzle the same way that you’d solve a numeric sudoku. Each of the bold words in the scripture below is found once in every row, column and 3×3 box.

Doctrine and Covenants 128:12

Herein is glory and honor, and immortality and eternal life—The ordinance of **baptism** by **water**, to be immersed therein in order to answer to the likeness of the dead, that one principle might accord with the other; to be immersed in the water and come forth out of the water is in the **likeness** of the **resurrection** of the **dead** in **coming forth out** of their **graves**; hence, this ordinance was instituted to form a relationship with the ordinance of baptism for the dead, being in likeness of the dead.

			baptism			forth	likeness	
			forth			water	graves	resurrection
	out			graves			baptism	
	graves	dead	coming			likeness		
		water	likeness				dead	
out		resurrection	graves					baptism
forth			dead	water			out	
			out		baptism	graves	forth	
graves			resurrection		forth		coming	

November 10–16

Doctrine and Covenants 129–132

“I Have Seen Your Sacrifices in Obedience”

Missing Vowels Word Search

Instructions: Find the hidden words. The words have been placed horizontally, vertically, diagonally, forwards, or backwards, and the vowels have been removed. When you locate a word, draw an ellipse around it and fill the vowels in.

Doctrine and Covenants 132:19

And again, verily I say unto you, if a **man marry a wife** by my **word**, which is my **law**, and by the **new** and **everlasting covenant**, and it is **sealed** unto them by the **Holy Spirit** of **promise**, by him who is **anointed**, unto whom I have **appointed** this **power** and the **keys** of this **priesthood**; and it shall be said unto them—Ye shall come forth in the first resurrection;... and shall inherit **thrones, kingdoms, principalities, and powers, dominions**, all heights and depths—then shall it be written in the **Lamb’s Book of Life**, ... and if ye abide in my covenant... it shall be **done** unto them in all things whatsoever my servant hath put upon them, in time, and through all **eternity**; and shall be of full **force** when they are out of the **world**.

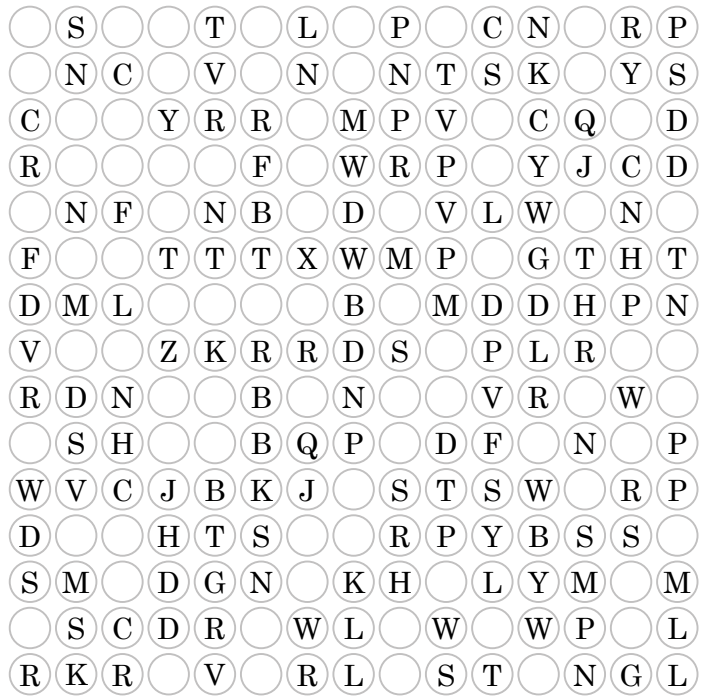

Word Star

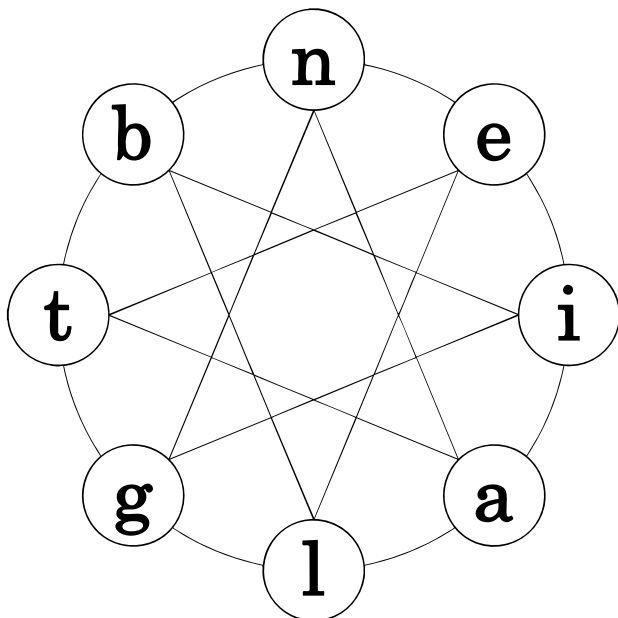

Instructions: Only one route through the word star will make a word. Try each letter and follow the pathway through the star to see if it makes a word.. IF you need a hint, look at the words in the scripture below. Write the letters of the word you discover in the blanks below as you travel through the star:

Now can you find this word in the following scripture?

Doctrine and Covenants 130:22

November 10–16

Doctrine and Covenants 129–132

“I Have Seen Your Sacrifices in Obedience”

God blesses me as I obey His laws.

Come, Follow Me 2025 Manual

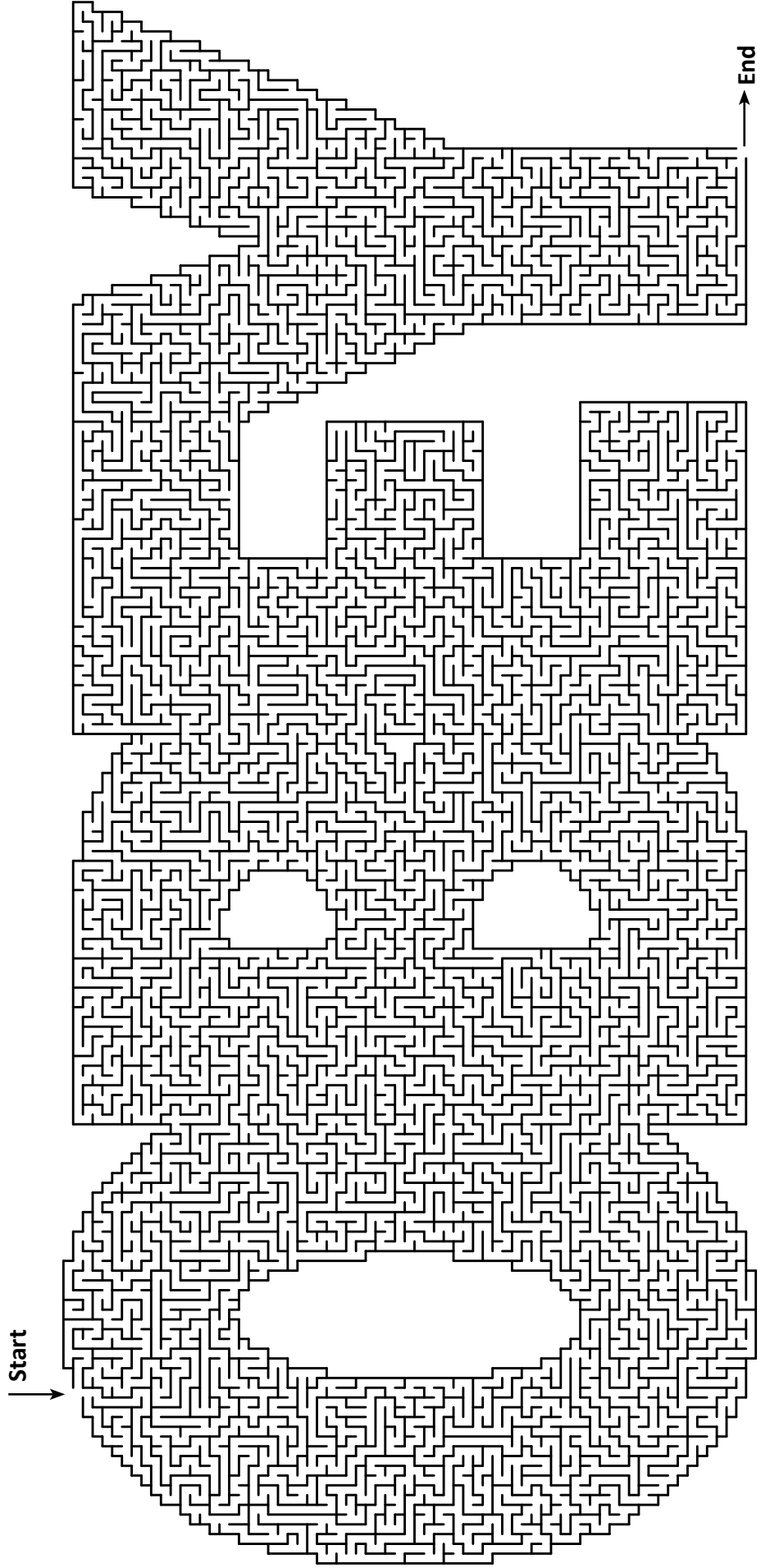

November 10–16

Doctrine and Covenants 129–132

“I Have Seen Your Sacrifices in Obedience”

Handwriting Practice

Practice your handwriting by tracing the sentence below. Then use the blank lines to write the sentence on your own.

Heavenly Father wants me to focus on eternal things.

Word Square

Instructions: Word squares are a liike Sudoku puzzles, but each letter can occur only once in each row and in each column. Check your puzzle against the answer key on ColorMeChristian.org. Every row and column must contain every letter in the word **ABIDE**. This word can be written in the gray row.

Doctrine and Covenants 132:5

For all who will have a blessing at my hands shall **abide** the law which was appointed for that blessing, and the conditions thereof, as were instituted from before the foundation of the world.

	E			I
		I		E
B	A			D
E				
		D		

Hidden Picture: Can you find the mom, dad, son, daughter, and baby in the picture below (2 copies of each)? This family wants to come together, go to the temple, and be sealed as a family forever. It will be tricky; the pictures may be smaller, on their side, or even upside down! Then, see if you can find one copy of the animals as well.

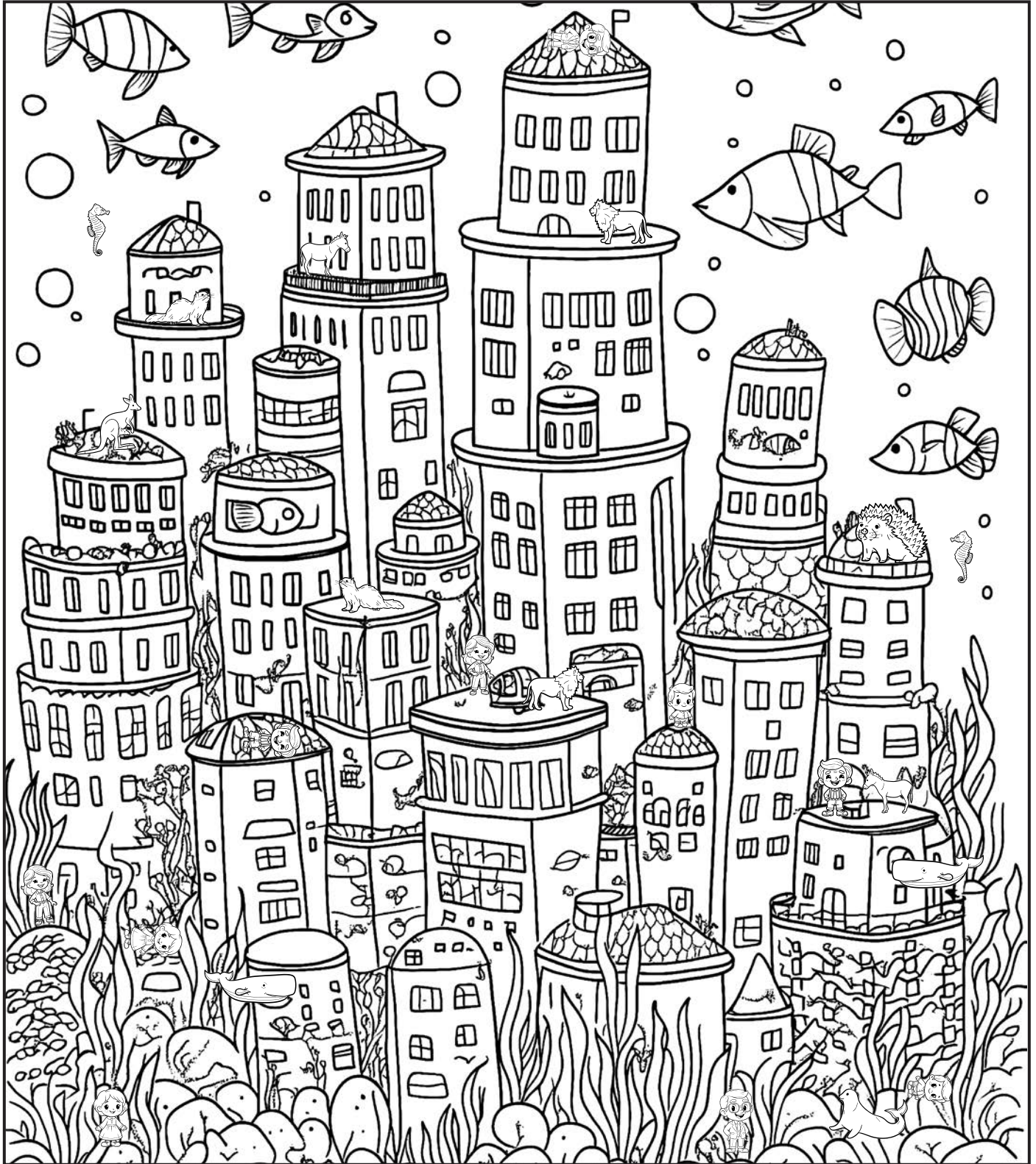

November 10–16

Doctrine and Covenants 129–132

“I Have Seen Your Sacrifices in Obedience”

Instructions: Fill in the blank puzzle grid using the word bank with the bold words from the scripture below. Place the words in the correct place on the grid.

Doctrine and Covenants 130:2, 18–19

And that same sociality which exists among us here will exist among us there, only it will be coupled with eternal glory, which glory we do not now enjoy. Whatever principle of intelligence we attain unto in this life, it will rise with us in the resurrection....And if a person gains more knowledge and intelligence in this life through his diligence and obedience than another, he will have so much the advantage in the world to come.

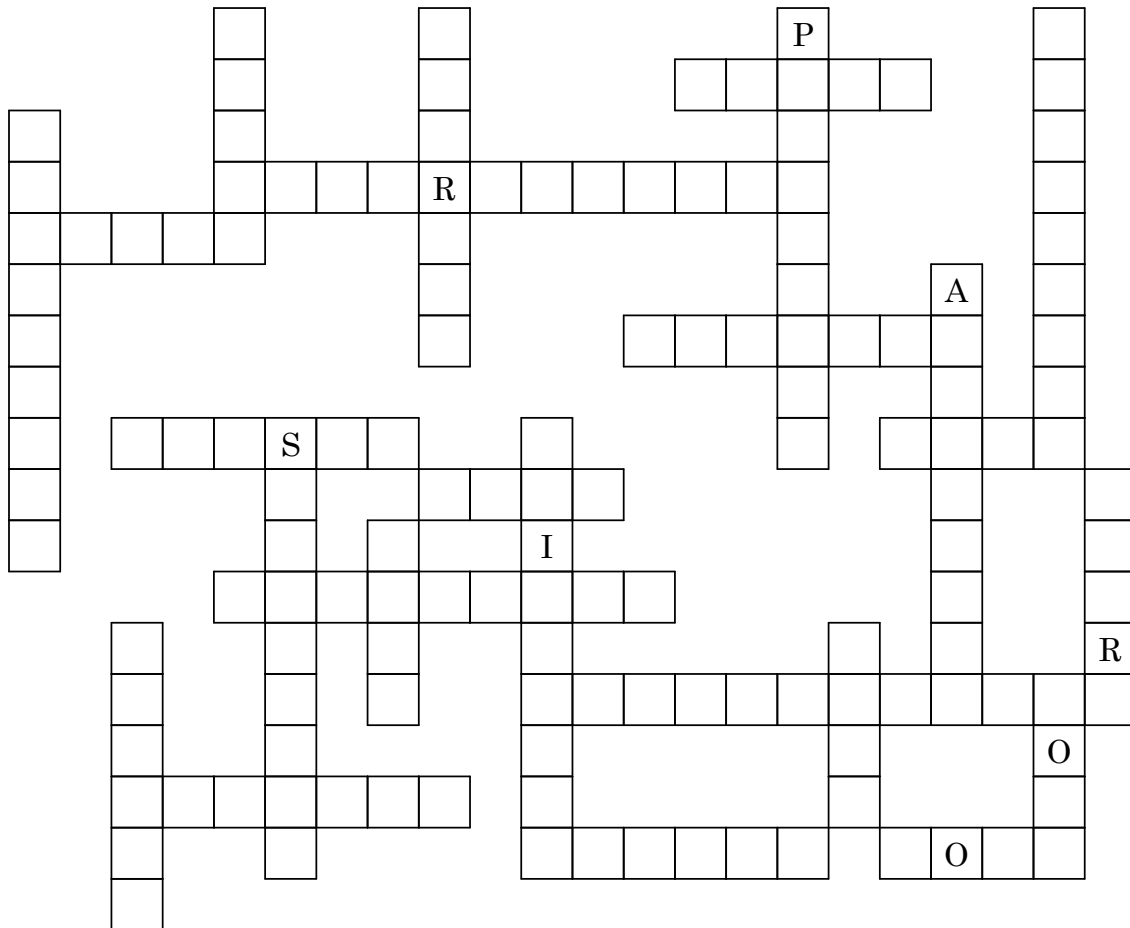

4 Letters here life come more rise same	5 Letters there world glory enjoy	attain person	9 Letters principle diligence sociality advantage principle knowledge obedience	12 Letters intelligence resurrection
	6 Letters exists	7 Letters another coupled eternal		

November 17–23

Doctrine and Covenants 133–134

“Prepare Ye for the Coming of the Bridegroom”



November 17–23

Doctrine and Covenants 133–134

“Prepare Ye for the Coming of the Bridegroom”

Wacky Word Trails

Instructions: Start with the circled letter, use the clues to find and mark the trail of letters of all the connected bolded words from the scripture through the maze to the last letter. The path can wander up, down, left, and right at any point, even in the middle of the word.

Doctrine and Covenants 134:1–2

We believe that **governments** were **instituted** of God for the **benefit** of **man**; and that he holds men **accountable** for their **acts** in **relation** to them, both in making **laws** and **administering** them, for the **good** and **safety** of **society**. We believe that no government can **exist** in **peace**, except such **laws** are **framed** and held **inviolable** as will **secure** to each **individual** the **free exercise** of **conscience**, the **right** and **control** of **property**, and the **protection** of **life**.

O	U	N	T	A	B	L	E	L	I	O	S	M	P	E	U	P	J	V
C	C	A	T	I	F	Z	F	E	F	E	C	U	O	R	T	Y	R	V
H	J	F	N	F	E	L	R	A	D	S	E	R	R	F	N	I	G	M
A	L	I	S	S	N	E	B	M	E	V	P	N	P	I	D	N	R	A
T	O	N	T	Y	T	E	Y	T	E	O	R	O	I	V	I	D	U	G
E	I	V	C	A	U	F	A	C	I	T	E	C	T	V	F	F	A	L
Q	J	N	G	O	O	D	S	O	S	T	H	G	I	F	X	W	K	E
G	R	O	I	I	D	K	G	Y	X	L	C	E	R	I	I	P	A	X
S	R	E	T	A	L	A	H	B	S	C	I	S	S	W	T	B	M	I
T	O	L	A	W	V	O	Q	A	J	R	E	H	Q	K	M	V	T	S
N	E	G	M	S	U	X	J	W	D	E	X	F	U	X	F	Y	C	O
X	M	L	A	F	F	F	I	H	E	M	E	A	R	F	F	T	I	N
W	N	P	N	I	T	I	T	U	T	Y	O	D	L	Y	V	U	T	T
F	R	O	G	N	S	J	R	W	M	C	V	V	O	R	J	I	L	R
U	E	V	G	A	A	D	F	M	D	A	P	E	A	A	Q	V	J	O
E	R	I	N	C	M	Z	Q	L	L	A	Z	Q	Q	R	Y	V	K	L
T	Q	B	Y	N	E	D	O	D	I	S	J	Q	T	P	E	R	E	P
S	W	W	D	A	S	G	M	T	B	R	I	C	O	C	T	X	A	C
I	N	I	M	A	W	A	L	E	C	N	E	S	N	E	E	R	F	E

Unscrambler

Instructions: Unscramble the words below; look at the bold words in the scripture for a hint.

Doctrine and Covenants 133:19–21, 25

Wherefore, **prepare** ye for the **coming** of the **Bridegroom**; go ye, go ye out to **meet** him. For behold, he shall stand upon the mount of **Olivet**, and upon the mighty ocean, even the great deep, and upon the islands of the sea, and upon the land of **Zion**. And he shall utter his voice out of Zion, and he shall speak from **Jerusalem**, and his voice shall be heard among all people;...And the Lord, even the **Savior**, shall stand in the **midst** of his **people**, and shall **reign** over all **flesh**.

idbegormro _____

zoin _____

raepepr _____

iolvte _____

fselh _____

osriva _____

teme _____

ocgmni _____

isdtm _____

regni _____

polepe _____

eauemjlrs _____

Escaping from Babylon

Help these children leave Babylon and come to Jesus in his home in Zion.

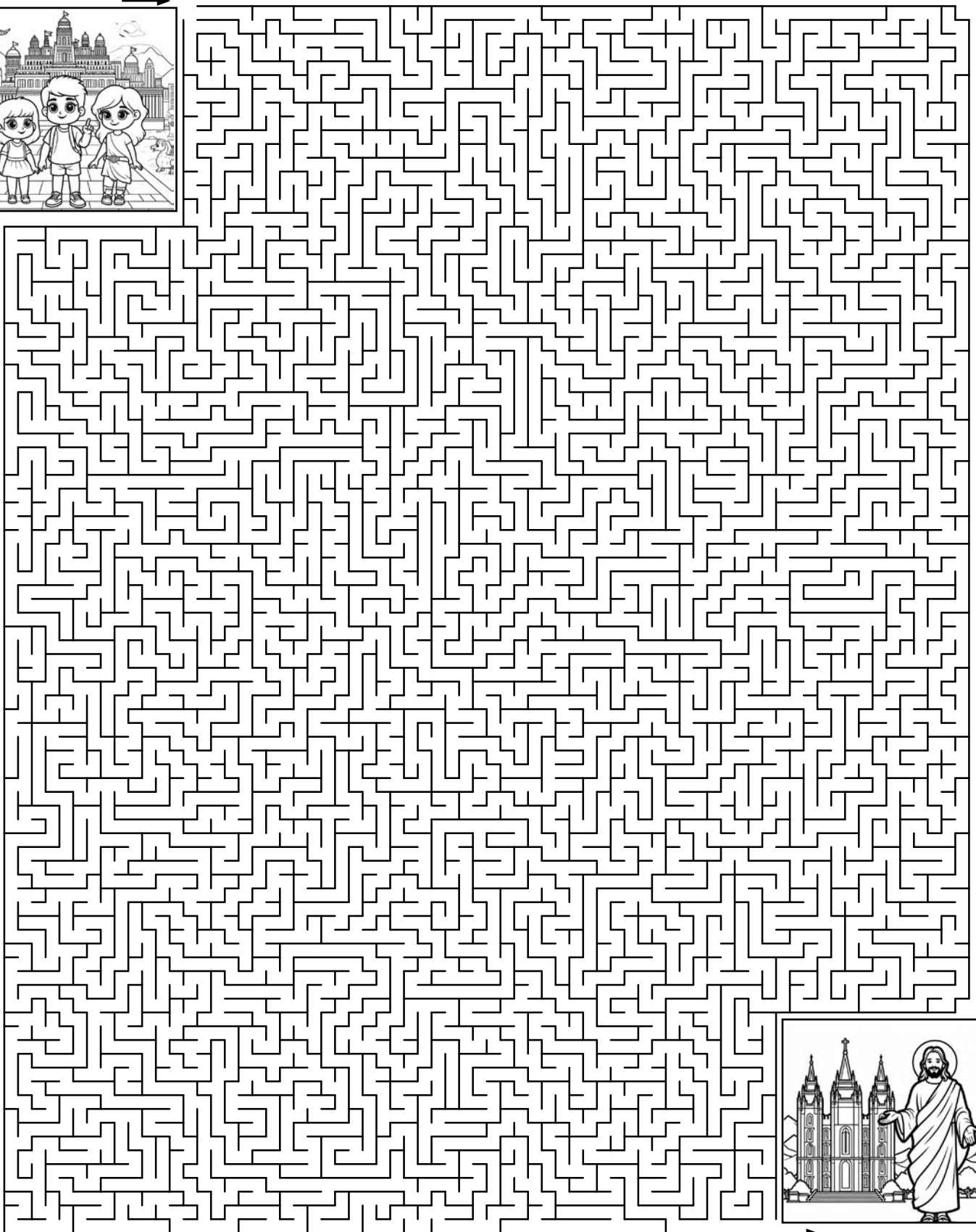

November 17–23

Doctrine and Covenants 133–134

“Prepare Ye for the Coming of the Bridegroom”

Letter Sudoku

Instructions: Solve the letter sudoku puzzle the same way you’d solve a numeric sudoku. Check your puzzle against the answer key on ColorMeChristian.org. Every column, row, and group of nine must contain every letter in the word(s) **LOVE PITY**.

Doctrine and Covenants 133:52–53

And now the year of my redeemed is come; and they shall mention the loving kindness of their Lord, and all that he has bestowed upon them according to his goodness, and according to his loving kindness, forever and ever. In all their afflictions he was afflicted. And the angel of his presence saved them; and in his **love**, and in his **pity**, he redeemed them, and bore them, and carried them all the days of old;

					O		Y
	P		E				
				E	T		L
	L			O			
T							
			Y				P
	I		P		L		
	V			T	I		O

Handwriting Practice

Practice your handwriting by tracing the sentence below. Then use the blank lines to write the sentence on your own.

Jesus Christ is loving and kind.

Blank handwriting practice lines for independent practice.

November 17–23

Doctrine and Covenants 133–134

“Prepare Ye for the Coming of the Bridegroom”

Instructions: Using the Across and Down clues, write the correct words in the numbered grid below. Hint: all of the words in the crossword come from the scripture below.

Doctrine and Covenants 133:19–25, 46–52

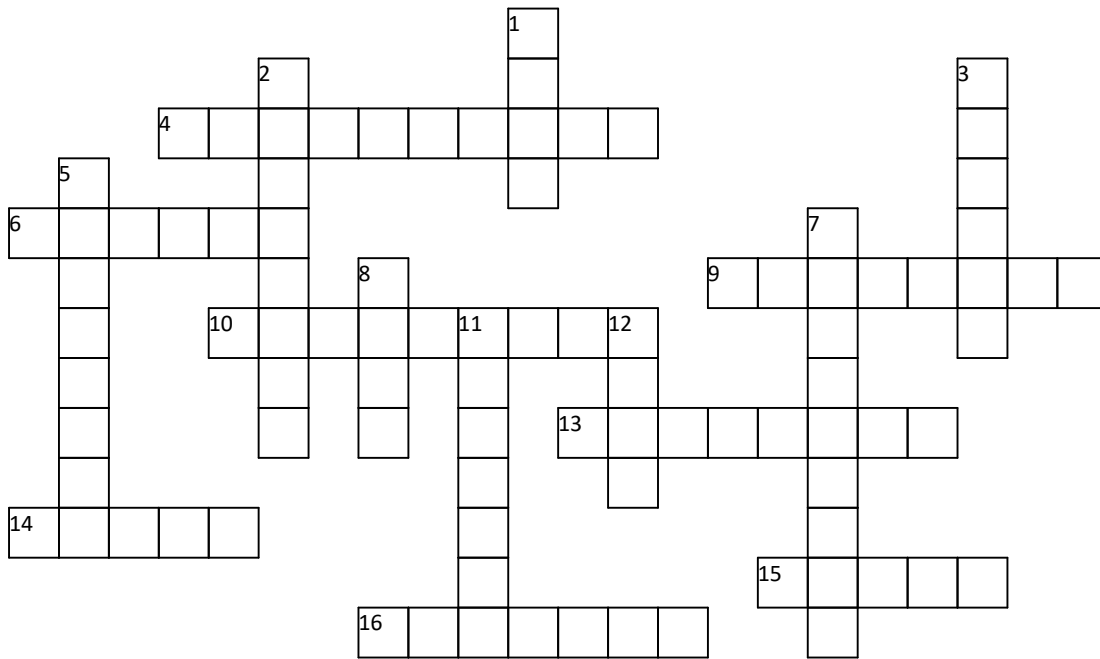

ACROSS

4. a man on his wedding day
6. throw forcefully
9. set one's foot down on top of
10. the capital ancient and modern Israel
13. moral excellence or admirableness
14. a fixed bright point in the night sky which is a large, burning ball of fire like the sun
15. a very large expanse of sea
16. a land mass that is surrounded by water

DOWN

1. the pure in heart; also the physical place the pure in heart gather
2. the quality of being warmhearted and considerate and humane
3. Mount of Olives; a place of many happenings in biblical times, and prominent in events of the latter days and the Messiah's Second Coming
5. the act of assessing a person or situation or event
7. harming someone in retaliation for something they have done
8. wild or violent anger
11. clothing
12. the natural satellite of the Earth

November 24–30

Doctrine and Covenants 135–136

He “Has Sealed His Mission and His Works with His Own Blood”

Reverse Word Search

Instructions: Instead of looking for words in a grid, place the bold words in the scripture in the empty word search puzzle. The words may be forwards, backwards, up, down, or diagonally. The start letter of the words have been placed in the grid to get you started.

Doctrine and Covenants 135:3

In the short space of **twenty years**, he has brought forth the **Book of Mormon**, which he **translated** by the **gift** and **power** of God, and has been the means of **publishing** it on two **continents**; has sent the fulness of the everlasting **gospel**, which it contained, to the **four quarters** of the **earth**; has brought forth the **revelations** and **commandments** which compose this book of **Doctrine** and **Covenants**, and many other wise **documents** and **instructions** for the **benefit** of the children of men; gathered many **thousands** of the Latter-day Saints, founded a great **city**, and left a **fame** and **name** that cannot be **slain**.

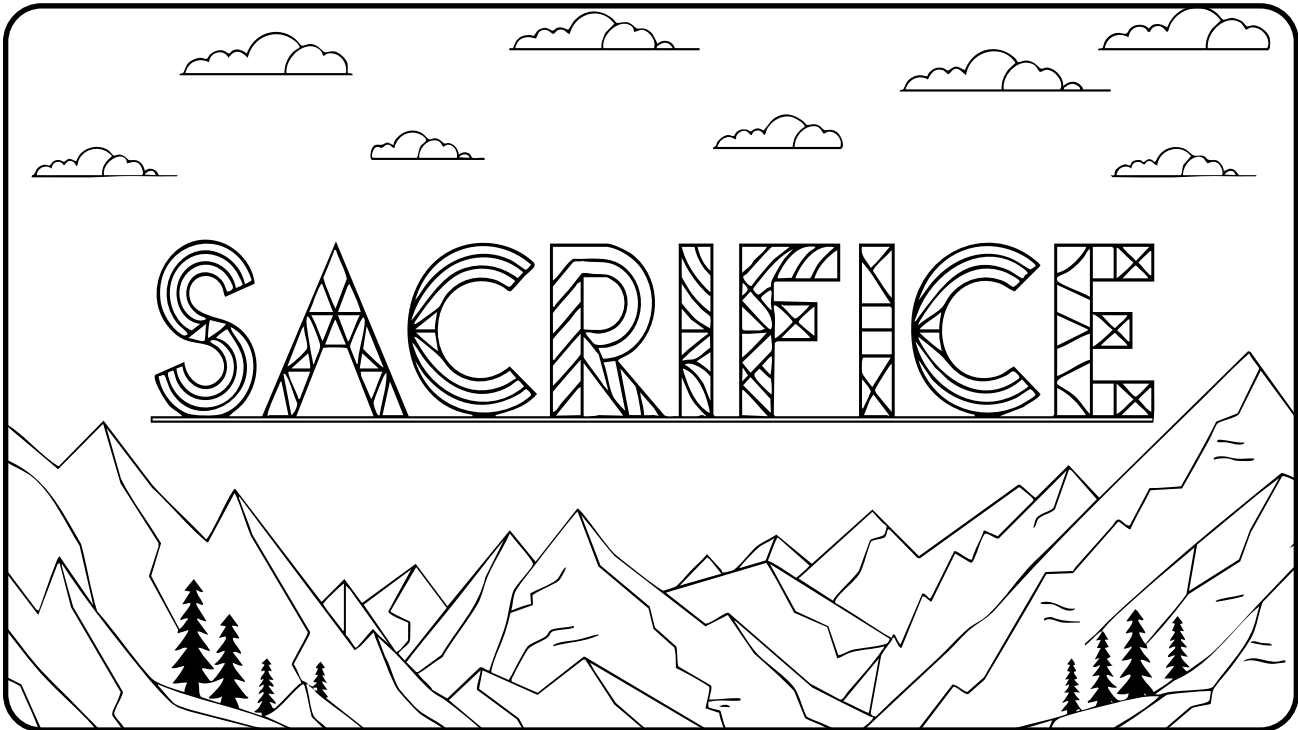
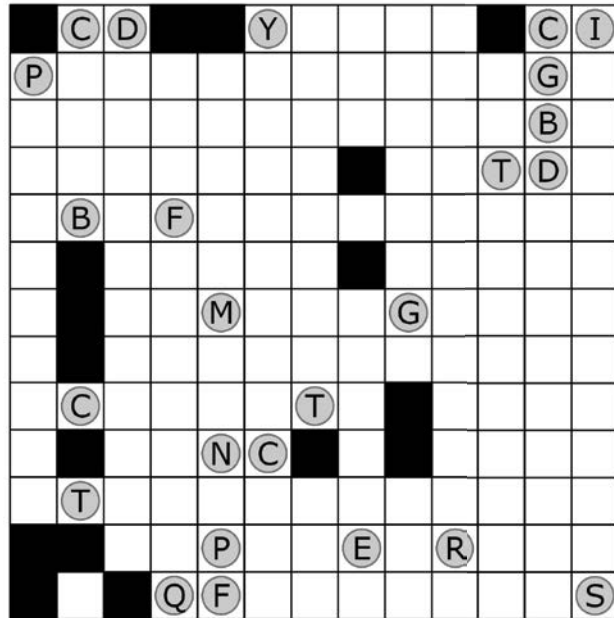

Joseph and Hyrum Smith gave their lives for Jesus Christ and His gospel.

Come, Follow Me 2025 Manual

The Saints Stop at Winter Quarters

By Arie Van De Graaff

The pioneers settled for a time at Winter Quarters to wait for winter to pass before continuing on their trek west. See if you can find the hidden objects in this picture.



Pencil



Piece of pie



Pot



Spoon



Spatula



Book



Wrench



Cup

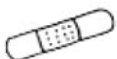

Bandage



Bowling pin



Carrot



Lollipop



Needle



Watch



Pear

November 24–30

Doctrine and Covenants 135–136

He “Has Sealed His Mission and His Works with His Own Blood”

Word Angles

Instructions: Find the bold words from the scripture. Each word path may run north, east, south, or west, may make one right-angled turn, and may cross another word path. A few words may make no right angle turn at all.

Doctrine and Covenants 135:1

To **seal** the **testimony** of this **book** and the Book of Mormon, we announce the **martyrdom** of **Joseph Smith** the **Prophet**, and **Hyrum Smith** the **Patriarch**. They were **shot** in **Carthage jail**, on the 27th of June, 1844, about five o'clock p.m., by an **armed mob**—painted black—of from 150 to 200 persons. Hyrum was shot first and fell **calmly**, exclaiming: I am a dead man! Joseph **leaped** from the **window**, and was shot dead in the attempt, **exclaiming**: O Lord my God!

X	V	V	U	E	H	X	H	R	Z	P	Z	M	F	D	B
O	B	R	Z	X	C	D	B	J	O	L	E	A	P	E	S
M	R	X	M	C	R	B	O	I	L	P	Q	Y	T	O	H
Y	B	S	R	L	A	E	O	K	A	E	S	X	I	R	C
E	O	X	H	A	I	K	C	F	O	J	O	P	K	K	J
G	N	I	M	I	R	T	A	P	O	M	L	Y	Z	Z	R
F	F	V	O	N	Y	C	M	G	E	L	Y	I	Q	H	Y
V	P	W	M	K	P	A	U	P	M	A	G	G	U	H	N
Z	B	B	I	O	O	R	R	D	R	C	E	M	F	D	L
G	R	I	T	S	I	T	B	M	Y	P	N	A	Y	S	Z
U	O	Z	S	H	N	H	A	G	E	S	L	R	T	E	K
D	E	M	E	T	M	U	R	Y	H	Y	I	T	N	H	F
C	K	R	T	I	M	S	T	M	O	D	R	Y	Y	P	D
W	G	A	R	J	T	L	I	A	J	H	P	E	S	O	Z
I	I	C	G	T	Y	E	I	J	X	L	C	I	O	R	O
N	D	O	W	U	D	E	E	M	U	T	N	Y	J	P	E

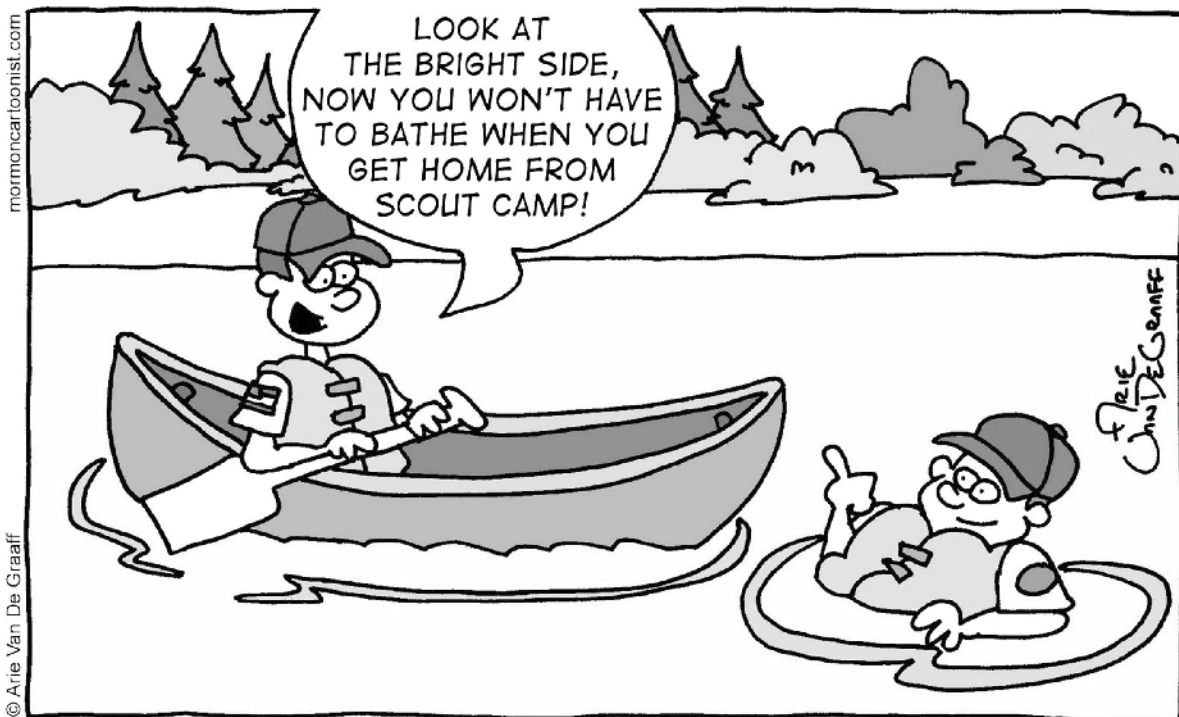

November 24–30

Doctrine and Covenants 135–136

He “Has Sealed His Mission and His Works with His Own Blood”

Instructions: Connect all of the letters in the maze and then write the phrase in the blanks below. Don't be tricked by letters that take you into a dead end! There is only one path through the maze.

----- ; -----
----- . -----

Doctrine and Covenants 136:17-18

Start

O	D	D	N	D	A	O	A	S	I	H	A	V	E	T	O	L	D	Y	O	U	D	A	E
A	D	N	A	N	D	O	A	S	I	H	A	V	E	T	O	U	O	U	A	N	D	F	
O	D	D	Y	A	N	O	A	S	I	H	A	V	E	L	O	L	D	U	A	N	D	A	E
A	O	W	A	Y	A	A	V	A	H	E	V	E	T	D	L	D	Y	A	F	E	A	R	N
T	H	Y	W	A	N	S	E	V	A	T	E	T	O	Y	D	F	D	N	D	F	E	A	O
O	T	H	Y	W	A	Y	A	E	T	O	T	O	L	O	Y	E	F	D	F	E	A	R	E
G	O	T	H	Y	W	A	Y	Y	D	L	O	L	D	Y	I	A	E	F	R	N	O	N	E
O	Y	H	Y	W	A	Y	A	O	Y	D	U	O	Y	I	H	R	A	E	A	T	H	I	N
T	W	Y	W	A	Y	A	A	U	O	Y	E	N	I	H	T	T	R	A	R	T	T	E	E
H	Y	W	A	Y	A	N	D	A	U	O	E	E	N	I	H	O	N	R	N	O	H	E	N
Y	W	A	Y	A	N	D	D	N	A	E	N	E	H	S	T	T	O	N	O	T	T	H	I
D	D	N	A	N	D	O	D	N	L	A	H	S	Y	H	T	T	O	S	F	H	N	N	
O	D	D	N	D	D	O	E	L	L	A	H	S	Y	E	R	O	F	S	E	I	M	E	E
A	O	D	D	D	O	A	V	A	H	L	A	L	E	H	T	F	S	E	I	M	E	N	E
S	A	O	D	O	A	S	A	H	T	O	Y	E	H	T	R	O	I	N	D	U	M	G	O
I	S	A	O	A	S	A	H	T	O	N	S	Y	E	H	T	R	M	E	N	E	G	E	G
H	I	S	A	P	E	V	A	O	N	L	L	A	Y	E	H	T	N	O	W	T	I	M	E
A	H	I	W	O	W	E	P	N	L	L	A	H	S	Y	E	H	I	Z	K	R	O	W	Y
V	E	H	E	W	O	P	T	O	T	O	N	L	L	A	Y	E	D	I	Z	K	R	O	M
E	T	A	R	E	W	O	P	T	H	T	L	L	A	H	S	Y	E	O	N	Z	K	R	P
T	O	V	T	W	O	P	E	V	A	O	N	L	L	A	H	S	M	N	A	L	Z	P	O
O	L	M	R	E	W	O	P	E	V	A	H	T	L	L	A	H	E	S	H	A	T	S	T
L	M	P	O	O	T	R	E	W	O	P	E	O	N	L	L	A	E	H	A	B	S	O	O
D	Y	O	T	S	O	T	W	O	P	E	V	T	O	T	L	L	D	A	L	L	O	T	O
Y	O	T	S	O	T	R	E	W	E	V	A	H	T	O	N	L	E	L	L	W	S	R	T
O	U	S	O	T	R	E	W	O	P	E	V	A	H	T	O	N	R	L	B	O	R	E	O
U	A	T	S	T	S	O	T	W	O	W	O	V	A	H	T	O	E	B	O	P	E	W	E
M	P	O	T	S	O	T	R	E	W	O	P	E	V	A	H	T	H	A	V	E	P	O	W

Finish

November 24–30

Doctrine and Covenants 135–136

He “Has Sealed His Mission and His Works with His Own Blood”

Cryptogram

Instructions: Each letter on the top stands for a letter in the alphabet. Solve the encrypted phrase by matching each letter on top to a letter in the alphabet on the bottom. Use the key to help you remember what the letters stand for so you can crack the code.

B	U	L	E	N	A	V	C	M	W	T	O	X	P	Q	F	D	H	K	G	S	J	Z	Y	R	I
A	B	C	D	E	F	G	H	I	J	K	L	M	N	O	P	Q	R	S	T	U	V	W	X	Y	Z

\bar{V} \bar{L} \bar{U} \bar{D} \bar{N} \bar{R} \bar{U} \bar{I} \bar{Z} \bar{K} \bar{R} , \bar{K} \bar{R} \bar{D} \bar{N} \bar{Y} \bar{L} \bar{N} \bar{R} \bar{D} \bar{K} \bar{F} \bar{E} \bar{Q}
 \bar{U} \bar{D} \bar{D} \bar{Y} \bar{L} \bar{P} \bar{K} \bar{R} \bar{D} \bar{C} \bar{L} \bar{Y} \bar{Q} , \bar{R} \bar{F} \bar{U} \bar{Q} \bar{L} \bar{E} \bar{D}
 \bar{I} \bar{L} \bar{Y} \bar{D} , \bar{U} \bar{F} \bar{G} \bar{D} \bar{V} \bar{D} \bar{U} \bar{B} \bar{U} \bar{L} \bar{E} \bar{C} \bar{X} , \bar{P} \bar{L} \bar{Y} \bar{K} \bar{R} \bar{D}
 \bar{U} \bar{F} \bar{C} \bar{G} \bar{F} \bar{K} \bar{Z} \bar{L} \bar{E} \bar{L} \bar{P} \bar{I} \bar{D} \bar{E} \bar{Z} \bar{E} \bar{K} \bar{R} \bar{Z} \bar{U} \bar{J} \bar{L} \bar{Y} \bar{C} \bar{Q} ,
 \bar{K} \bar{R} \bar{F} \bar{E} \bar{F} \bar{E} \bar{X} \bar{L} \bar{K} \bar{R} \bar{D} \bar{Y} \bar{I} \bar{F} \bar{E} \bar{K} \bar{R} \bar{F} \bar{K} \bar{D} \bar{G} \bar{D} \bar{Y}
 \bar{C} \bar{Z} \bar{G} \bar{D} \bar{Q} \bar{Z} \bar{E} \bar{Z} \bar{K} . \bar{Q} \bar{L} \bar{H} \bar{K} \bar{Y} \bar{Z} \bar{E} \bar{D} \bar{F} \bar{E} \bar{Q}
 \bar{H} \bar{L} \bar{G} \bar{D} \bar{E} \bar{F} \bar{E} \bar{K} \bar{U} 1 3 5 : 3

Letterbox Puzzle

Instructions: Find the hidden word in the puzzle below by crossing out all letters that occur twice or more. Capitalized and lowercase letters count as unique letters for this puzzle. The letters left over will form a word. Write down the left over letters like you would read a book, from left to right and top to bottom. Then find the hidden word in the scripture or phrase below and circle it.

Doctrine and Covenants 135:4

When Joseph went to Carthage to deliver himself up to the pretended requirements of the law, two or three days previous to his assassination, he said: “I am going like a lamb to the slaughter; but I am calm as a summer’s morning; I have a conscience void of offense towards God, and towards all men. I shall die innocent, and it shall yet be said of me—he was murdered in cold blood.”

Write the hidden word:

n	M	X	s	j	l
x	l	W	W	a	m
r	U	x	G	l	g
n	h	S	S	X	Q
t	g	Q	M	E	j
R	D	m	r	D	g

December 1–7

Doctrine and Covenants 137–138

“The Vision of the Redemption of the Dead”

Word Search

Instructions: Find the bold words from the scripture in the word search puzzle. Each word could be hidden forwards, backwards, up, down, or diagonally.

Doctrine and Covenants 137:7-9

Thus came the **voice** of the Lord unto me, saying: All who have **died without a knowledge** of this **gospel**, who would have **received** it if they had been **permitted to tarry**, shall be **heirs** of the **celestial kingdom** of God; Also all that shall **die henceforth** without a knowledge of it, who would have received it with all their **hearts**, shall be heirs of that kingdom; For I, the Lord, will **judge** all **men** according to their **works**, according to the **desire** of their hearts.

O	H	Q	K	I	E	H	S	V	B	M	D	R	D	I
J	E	S	G	M	N	X	S	S	H	V	Y	P	E	Q
X	I	S	T	A	R	R	Y	J	T	V	P	L	S	G
P	R	K	H	C	E	L	E	S	T	I	A	L	I	C
W	S	J	I	L	L	P	V	R	T	D	W	H	R	N
G	H	G	D	N	X	Q	D	R	I	Y	O	P	E	Z
G	E	E	V	E	G	M	S	E	T	S	R	E	C	N
J	N	G	Z	M	I	D	H	U	Q	T	K	R	E	N
F	C	D	C	T	L	D	O	D	Q	R	S	M	I	E
M	E	E	H	D	L	H	D	M	L	A	E	I	V	I
D	F	L	R	M	T	V	L	E	E	E	C	T	E	S
Y	O	W	N	I	G	O	J	G	P	H	L	T	D	Q
D	R	O	W	W	B	I	L	D	S	D	N	E	A	F
B	T	N	L	N	U	C	U	U	O	A	Z	D	E	Q
W	H	K	V	R	I	E	K	J	G	K	N	E	M	S

Knight Moves - Find a Word

Instructions: Start with any letter in the puzzle to see if it's the beginning of a word. To get to the second letter, jump two squares in any direction except diagonally, and then one square in a different direction. Your path will look like a capital L. Only one route through the puzzle will make a word. Write the letters of the word you discover in the blanks below as you jump through the squares:

1 2 3 4 5 6 7 8

Now can you find this word in the following scripture?

Doctrine and Covenants 138:18–19

n	t	d
o		i
r	e	c

December 1-7

Doctrine and Covenants 137-138

“The Vision of the Redemption of the Dead”

Word Guess

Instructions: Write your word guesses in the puzzle below. For extra hints, look at the words/phrases in the scripture below. Check the answer on ColorMeChristian.org

	L	V				F				H
			E	D		H				
S		N				O				
			E	N		C			N	
T	E			A		P				

Doctrine and Covenants 138:23-24

And the saints rejoiced in their redemption, and bowed the knee and acknowledged the Son of God as their Redeemer and Deliverer from death and the chains of hell. Their countenances shone, and the radiance from the presence of the Lord rested upon them, and they sang praises unto his holy name.

Fallen Phrase

Instructions: The letters in each column have fallen from the grid. Put them back correctly to rebuild the phrase. Cross out each letter in the jumble below once you place it in the grid. Pay attention because the letters in each column are scrambled. Start with simple 1 or 2 letter words and use the process of elimination. To check your answer, read: **Doctrine and Covenants 137:10**

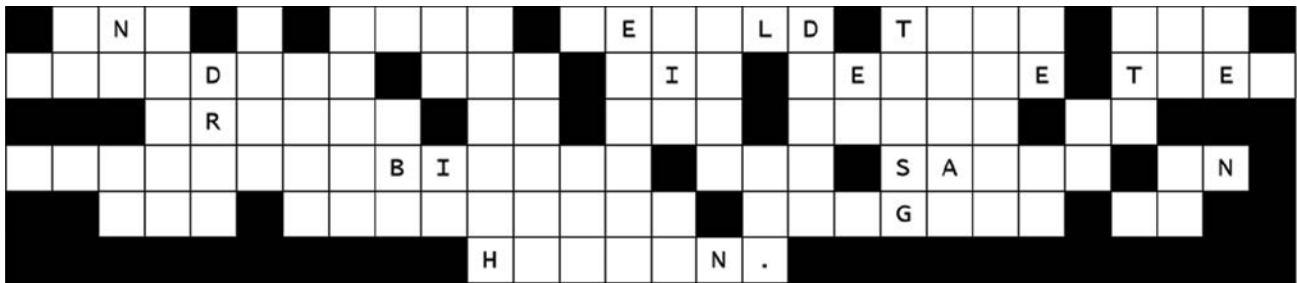

A E S I D A
 O R C A O T B Y H A E H S L
 H T H I I V L E A E A V H E Y R V E A H
 C C I L U N E A L S L O I A L E R I E A D O M D F F
 A A C D E R T N E W H T T T E E K B N F O R T O O I L Y

December 1-7

Doctrine and Covenants 137-138

"The Vision of the Redemption of the Dead"



Translation Station

Instructions: Translate the sign language letters below into English to discover the hidden message. Write the alphabet letter beneath each hand sign. Use the key at the back of the book to help you.

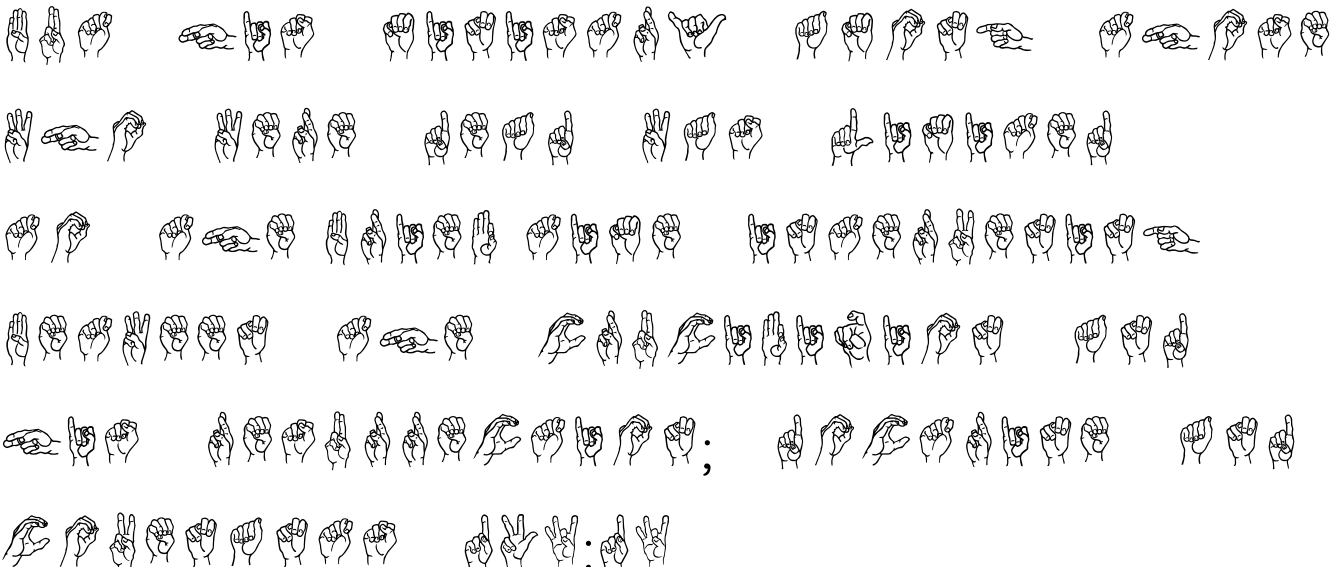

December 1-7

Doctrine and Covenants 137-138

“The Vision of the Redemption of the Dead”

All Heavenly Father’s children will have the chance to **hear** the gospel.

Come, Follow Me 2025 Manual

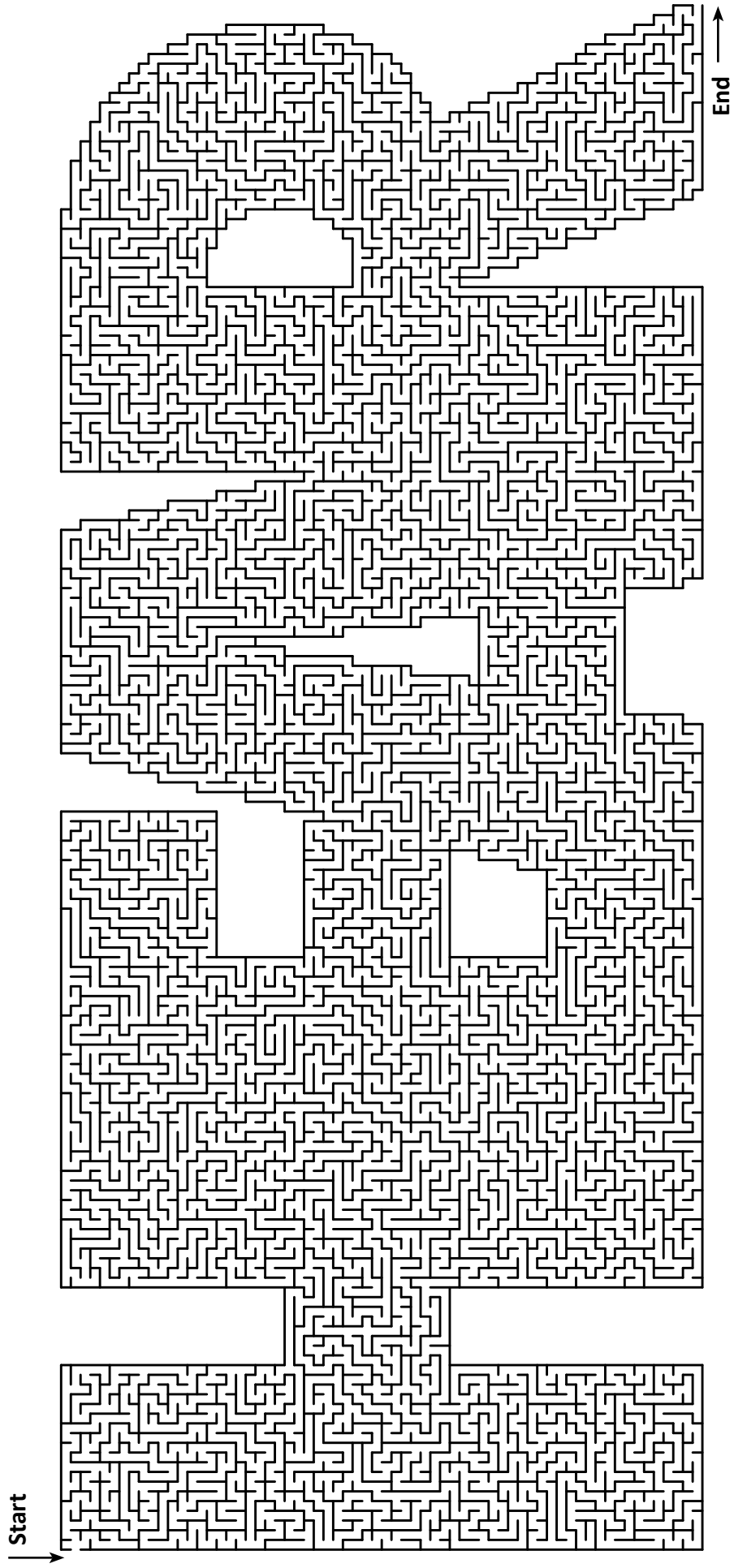

December 1–7

Doctrine and Covenants 137–138

“The Vision of the Redemption of the Dead”

Word Sudoku

Instructions: Solve this word sudoku puzzle the same way that you’d solve a numeric sudoku. Each of the bold words in the scripture below is found once in every row, column and 3×3 box.

Doctrine and Covenants 138:6, 11

I opened the **Bible** and **read** the third and fourth chapters of the first epistle of Peter, and as I read I was greatly impressed, more than I had ever been before, with the following passages:…As I **pondered** over these things which are written, the **eyes** of my understanding were **opened**, and the **Spirit** of the Lord rested upon me, and I **saw** the **hosts** of the **dead**, both small and great.

read	hosts							eyes
		opened	saw			pondered		Bible
	Bible			eyes			Spirit	read
	saw		eyes	opened				pondered
	eyes	hosts		Spirit				saw
	pondered	Spirit		hosts		eyes		
pondered			hosts	saw			eyes	
Spirit	opened				eyes	read		
hosts		eyes	opened					Spirit

December 8–14

The Articles of Faith and Official Declarations 1 and 2

“We Believe”

Missing Vowels Word Search

Instructions: Find the hidden words. The words have been placed horizontally, vertically, diagonally, forwards, or backwards, and the vowels have been removed. When you locate a word, draw an ellipse around it and fill the vowels in.

Jacob 2:27–30

Wherefore, my brethren, hear me, and hearken to the word of the Lord: For there shall not any **man** among you have save it be **one wife**; and **concubines** he shall have **none**; For I, the Lord God, **delight** in the **chastity** of **women**. And **whoredoms** are an **abomination** before me; thus saith the Lord of **Hosts**. Wherefore, this people shall **keep** my **commandments**, saith the Lord of Hosts, or **cursed** be the **land** for their **sakes**. For if I will, saith the Lord of Hosts, **raise** up **seed** unto me, I will **command** my people; otherwise they shall **hearken** unto **these things**.

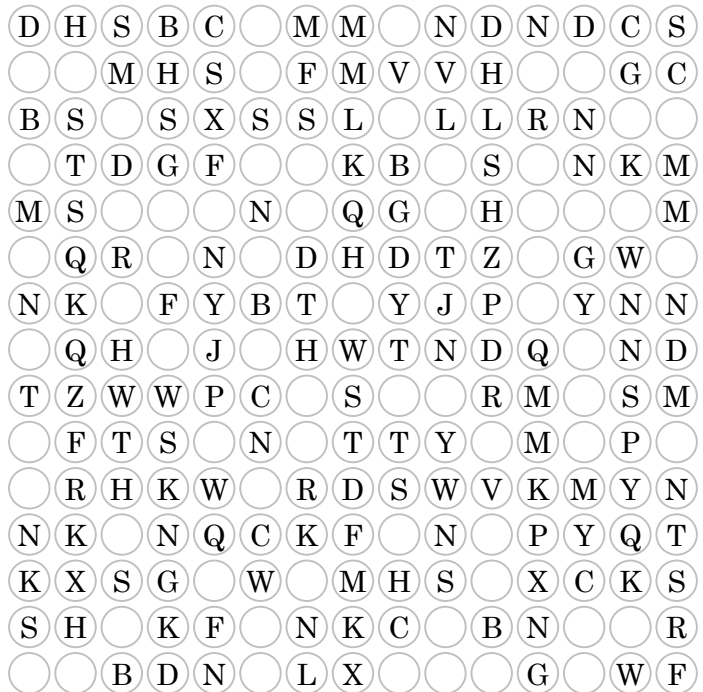

Fill in the Blank

Articles of Faith 1:10

We _____ in the literal _____ of _____ and in the _____ of the _____ Tribes; that _____ (the New _____) will be _____ upon the _____ continent; that _____ will _____ upon the _____; and, that the earth will be _____ and receive its _____ glory.

American	paradisiacal	built	gathering	Zion	restoration
earth	reign	personally	renewed	Ten	Christ
believe	Israel	Jerusalem			

Hidden Picture: The Lord guides His Church through His prophet. Can you find 2 copies of the prophet and the church in the hidden picture below? It will be tricky; the pictures may be smaller, on their side, or even upside down! Then, see if you can find one copy of the animals as well.

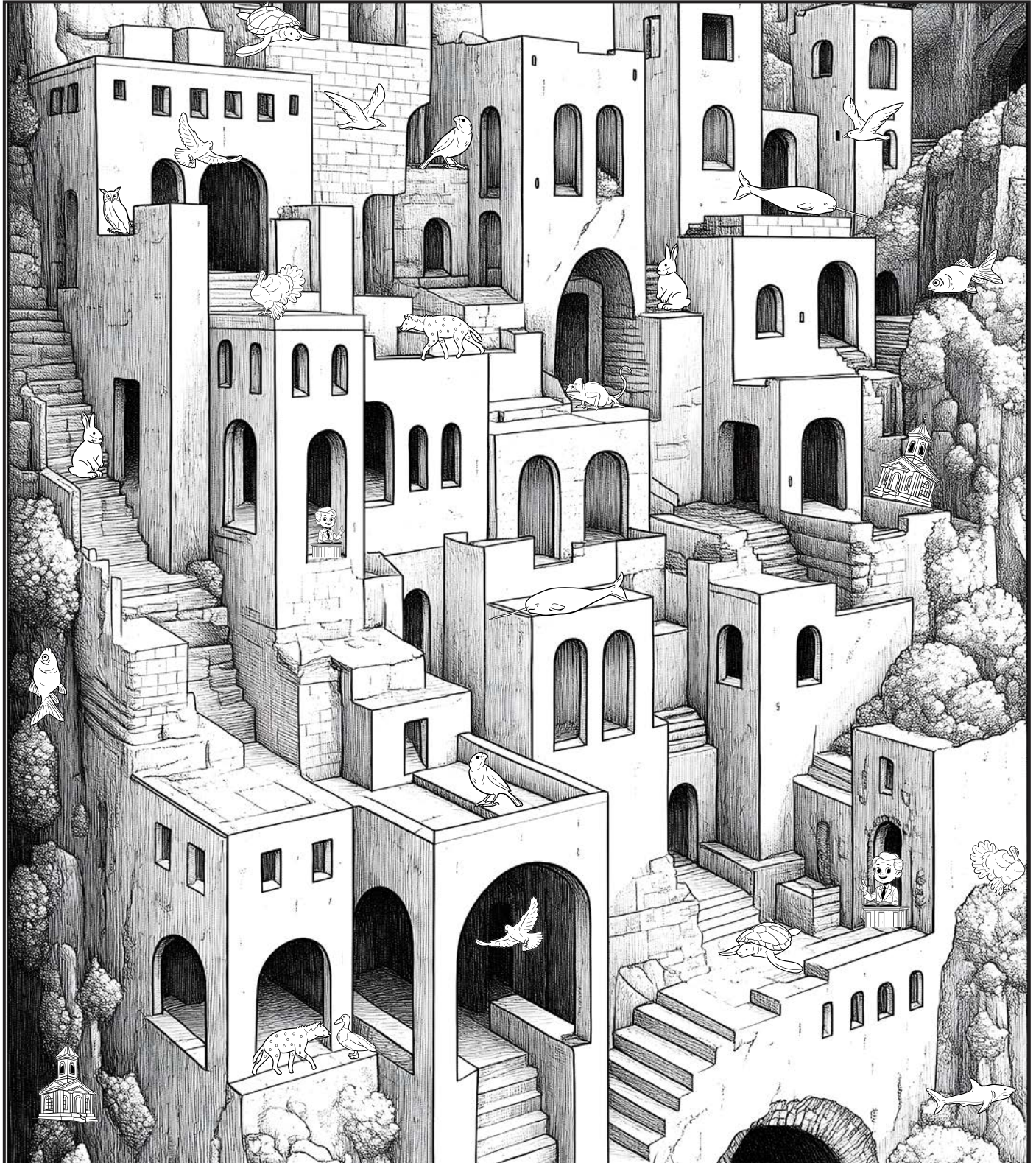
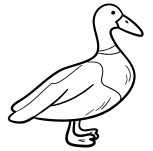
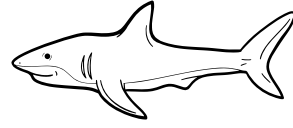
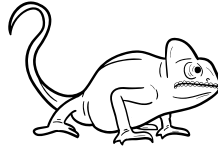

December 8–14

The Articles of Faith and Official Declarations 1 and 2

“We Believe”

Word Spiral

Instructions: Fill in the blank puzzle grid using the bold words from the scripture or phrase below. *The bold words may not all be used!* Use the letter hint below and count the letters of the bold words to figure out where each word goes. Then transfer the letters that have little numbers in their box to the hidden word at the bottom of the puzzle. Check the answer on ColorMeChristian.org.

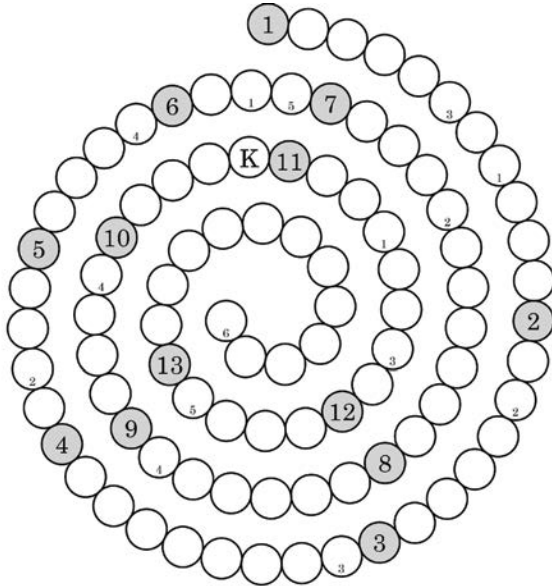

Articles of Faith 1:13

We **believe** in being **honest, true, chaste, benevolent, virtuous**, and in doing **good** to **all** men; indeed, we may say that we follow the **admonition** of **Paul**—We believe all things, we **hope** all things, we have **endured** many things, and hope to be able to endure all things. If there is anything virtuous, **lovely**, or of good report or **praiseworthy**, we **seek** after these things.

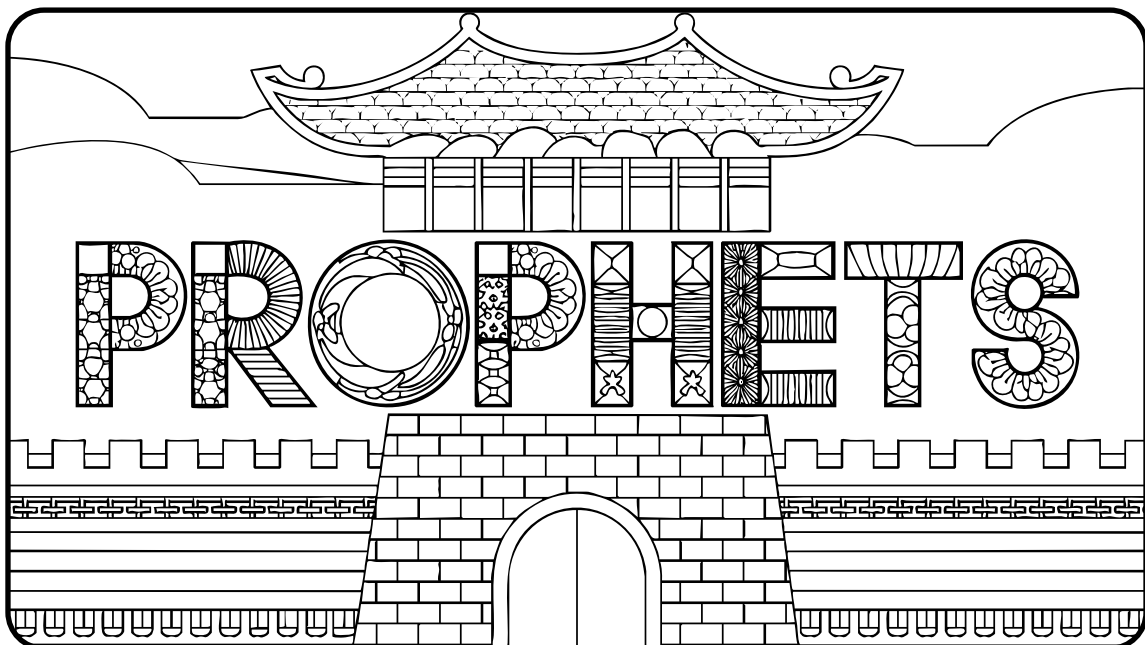
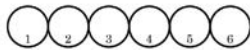

Prophets help us know the will of Heavenly Father. (Come, Follow Me 2025 Manual)

Hearken to the Prophet

Prophets continue to receive revelation from the Lord to guide the church. Can you help these children through the maze so they can listen to and follow the prophet?

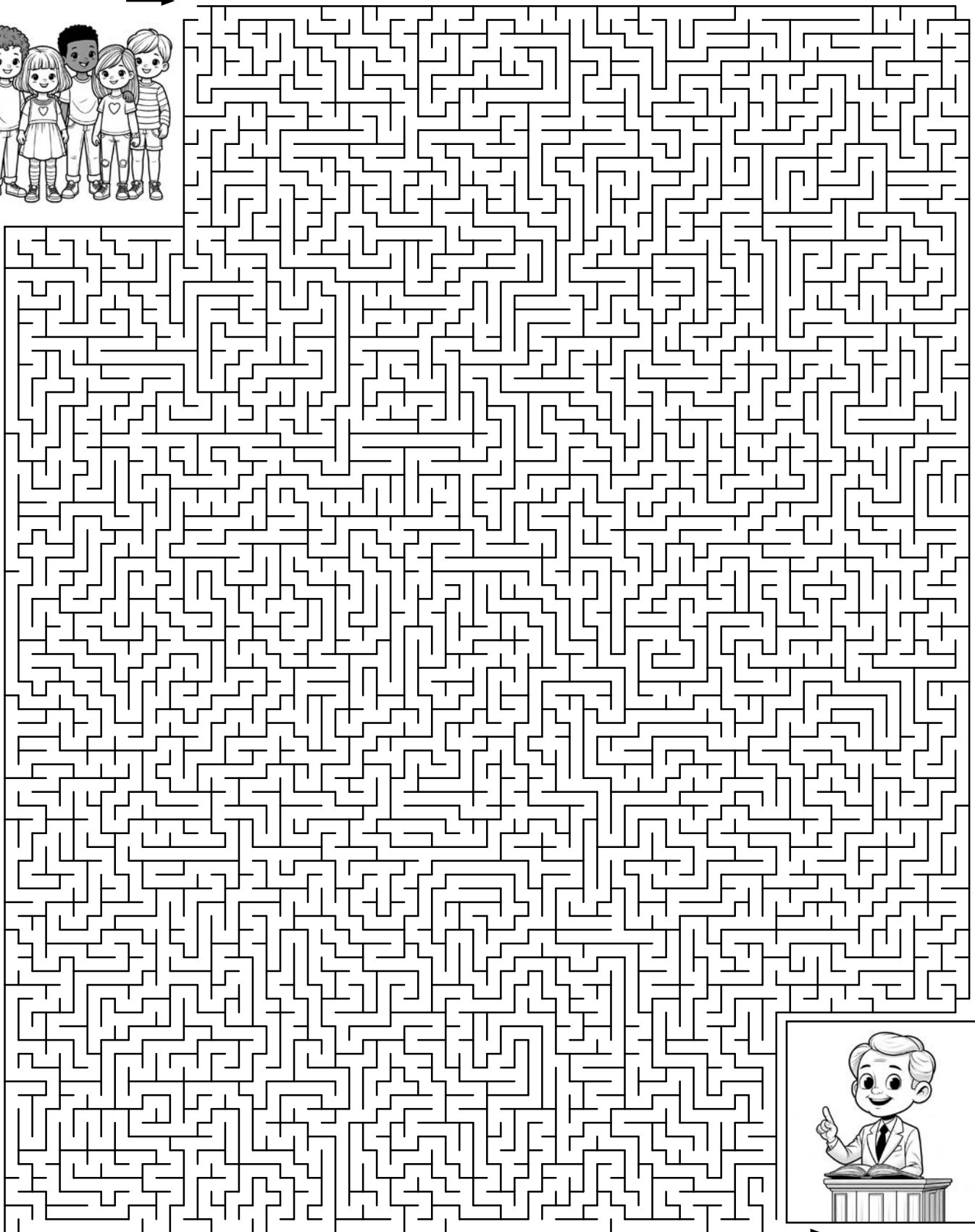

December 8–14

The Articles of Faith and Official Declarations 1 and 2

“We Believe”



Word Square

Instructions: Word squares are a liike Sudoku puzzles, but each letter can occur only once in each row and in each column. Check your puzzle against the answer key on ColorMeChristian.org. Every row and column must contain every letter in the word **WORKETH**. This word can be written in the gray row.

Acts 10:34–35

Then Peter opened his mouth, and said, Of a truth I perceive that God is no respecter of persons: But in every nation he that feareth him, and **worketh** righteousness, is accepted with him.

R	H		T	E	O	
K			W		R	H
H	T				K	
E						T
	R			K		
O	K		E	H	W	
T			K			

December 15–21

The Family: A Proclamation to the World

“The Family Is Central to the Creator’s Plan”

FAMILIES

ARE

HAPPIEST

WHEN THEY FOLLOW

JESUS

CHRIST

December 15–21

The Family: A Proclamation to the World

“The Family Is Central to the Creator’s Plan”

Wacky Word Trails

Instructions: Start with the circled letter, use the clues to find and mark the trail of letters of all the connected bolded words from the scripture through the maze to the last letter. The path can wander up, down, left, and right at any point, even in the middle of the word.

The Family Proclamation, Paragraph 3

The **divine plan** of **happiness** enables **family relationships** to be **perpetuated beyond** the **grave**. **Sacred ordinances** and **covenants** available in **holy temples** make it **possible** for **individuals** to **return** to the **presence** of **God** and for **families** to be **united eternally**.

K	R	X	Z	U	C	F	X	T	I	O	N	O	L	U	B
K	G	K	K	X	A	D	L	A	Y	H	S	H	V	R	C
O	O	E	N	K	M	T	E	R	E	I	J	E	T	U	R
N	E	E	H	X	G	P	V	B	L	P	S	R	F	D	N
A	C	S	Q	H	D	P	O	I	P	R	Y	L	A	O	G
Z	Z	Q	L	Y	E	T	S	S	E	E	P	I	M	V	P
E	M	P	O	U	N	I	B	Q	T	W	P	I	D	L	P
T	Z	L	H	V	K	S	D	E	U	F	I	V	U	Y	S
S	M	E	S	C	E	S	H	T	A	S	D	N	A	L	S
E	L	O	G	B	N	P	A	D	M	Q	L	I	H	Y	P
I	M	A	F	D	I	P	E	S	E	N	C	E	F	D	L
L	I	A	U	E	R	C	R	N	R	E	D	R	O	N	A
P	P	O	T	S	S	A	P	A	E	T	I	N	R	V	L
C	N	X	N	A	N	E	V	L	E	V	S	A	P	S	D
H	C	W	K	W	D	C	O	L	Y	A	I	N	C	E	I
P	Q	Y	W	L	N	O	Y	E	B	R	G	E	N	I	V

Unscrambler

Instructions: Unscramble the words below; look at the bold words in the scripture for a hint.

The Family Proclamation, Paragraph 2

All **human** beings—male and female—are **created** in the **image** of **God**. Each is a beloved **spirit** son or daughter of **heavenly parents**, and, as such, each has a **divine nature** and destiny. **Gender** is an **essential characteristic** of individual premortal, mortal, and eternal identity and purpose.

ntspare _____

inediv _____

ialessent _____

geima _____

urenat _____

dcreate _____

ritspi _____

dgo _____

iccharacterist _____

nhuma _____

dergen _____

nlyheave _____

December 15–21

The Family: A Proclamation to the World

“The Family Is Central to the Creator’s Plan”



Translation Station

Instructions: Translate the sign language letters below into English to discover the hidden message. Write the alphabet letter beneath each hand sign. Use the key at the back of the book to help you.



Instructions: Connect all of the letters in the maze and then write the phrase in the blanks below.

The Family Proclamation, Paragraph 3

Start

T	A	F	L	A	N	R	E	T	E	R	E	R	I	R	E	T	E	F	L	A	H	E	A	D	E	T	C	C	A	D	A	C
H	T	A	T	L	A	E	T	E	R	I	E	I	E	I	R	E	T	L	A	N	T	A	F	E	D	P	E	A	D	N	C	C
E	H	T	A	F	E	T	E	R	I	E	H	E	H	E	I	R	E	A	N	R	A	F	L	T	P	E	C	C	N	A	N	E
E	T	E	R	I	E	E	R	I	E	H	T	H	T	H	E	E	A	N	A	E	R	L	A	L	F	A	D	N	A	R	A	P
R	S	R	I	E	H	T	E	R	I	E	S	A	S	T	H	E	N	R	E	T	N	R	N	A	A	F	A	E	H	E	E	T
S	A	I	E	H	T	S	T	S	A	D	O	D	A	S	T	H	R	E	T	E	R	E	R	N	A	L	F	H	T	H	E	E
A	D	E	H	T	S	A	S	A	D	O	G	O	D	A	S	T	H	E	E	R	E	T	E	R	N	A	A	F	A	T	H	D
D	O	H	T	S	A	D	O	D	O	G	D	G	O	D	A	S	T	H	E	I	R	E	T	E	R	N	A	L	F	A	I	H
O	G	D	G	A	D	O	G	D	E	P	E	D	D	E	H	T	H	E	E	R	E	T	E	R	N	A	L	F	A	P	S	P
G	D	E	P	P	O	G	D	E	P	P	P	E	D	G	E	H	E	I	T	N	R	H	T	L	A	R	E	L	T	N	P	N
D	E	D	P	I	G	D	E	P	P	I	P	P	E	D	I	E	I	R	L	A	N	A	A	F	R	D	L	I	N	A	L	A
G	P	P	I	H	I	H	S	R	S	H	I	E	D	G	O	I	R	E	F	L	A	N	E	R	D	L	I	H	C	S	A	N
O	P	I	H	S	R	O	W	O	R	S	H	D	S	O	D	A	E	T	A	U	O	C	N	E	R	D	R	I	H	I	N	B
M	I	H	S	R	O	W	D	R	S	H	I	G	A	D	A	Y	B	O	D	L	U	L	U	O	E	R	E	S	H	Y	B	Y
E	H	S	R	O	W	D	N	I	H	I	P	O	D	A	S	D	Y	B	O	B	L	U	O	C	N	E	O	H	C	W	Y	W
R	E	H	S	R	D	N	A	N	D	W	O	R	S	H	D	O	B	O	A	C	A	L	D	O	C	N	C	C	I	H	I	N
P	R	P	R	D	W	A	W	A	N	O	R	S	H	I	O	B	L	A	C	I	C	D	L	U	O	C	L	L	I	F	E	I
E	H	E	P	N	D	N	E	W	A	N	D	W	I	P	B	L	A	C	I	S	I	T	B	L	U	O	A	L	L	I	F	E
N	T	H	E	A	W	E	N	E	W	A	N	D	N	A	L	A	C	I	S	Y	H	P	O	D	L	U	N	L	I	F	E	I
I	N	T	H	N	K	S	K	N	E	W	D	W	A	Y	A	C	I	S	Y	H	P	A	P	H	D	L	R	N	F	E	I	N
P	T	H	E	R	S	R	S	K	N	A	N	A	Y	D	Y	D	S	Y	H	P	A	N	A	P	O	D	E	R	E	T	N	T
E	H	E	P	E	R	E	R	S	E	W	A	Y	D	O	B	O	Y	H	P	A	N	I	A	T	B	O	T	E	F	O	S	O
E	E	P	E	T	E	T	E	R	Y	D	N	D	O	B	L	A	C	Y	H	Y	A	N	I	I	N	E	D	E	S	T	R	S
R	P	R	R	H	G	H	T	H	L	R	A	O	B	L	A	C	I	S	Y	S	I	D	I	V	I	D	E	S	N	I	E	I
E	R	I	R	G	U	T	E	T	H	N	E	D	O	B	L	B	C	I	C	I	D	R	D	I	N	T	S	T	Y	N	S	H
M	E	P	I	R	A	U	A	R	T	I	N	Y	D	O	D	O	A	C	A	L	R	I	V	E	I	T	I	A	Y	A	S	
O	P	S	P	I	D	A	E	A	I	A	I	A	Y	D	Y	A	L	A	L	R	I	E	I	I	N	N	I	H	S	A	S	H
R	T	M	I	R	D	E	N	I	A	G	D	N	A	Y	A	N	B	L	R	I	E	H	E	I	E	D	I	E	H	S	H	E
T	A	L	T	I	N	A	R	T	I	N	E	D	N	A	N	D	O	R	I	E	H	T	I	R	D	E	R	I	E	H	E	I
A	L	A	S	O	A	R	T	E	N	E	A	G	D	G	A	G	D	Y	R	I	E	E	T	H	E	I	S	R	I	R	I	R
L	R	E	O	N	S	T	H	A	E	A	R	A	I	A	I	A	I	A	H	T	E	Z	E	T	H	E	I	R	R	S	O	S
R	E	A	N	D	A	H	L	X	P	M	I	M	N	I	N	D	R	D	T	E	Z	I	Z	E	T	H	E	I	R	D	I	O
E	A	L	M	D	N	L	Y	E	X	C	T	I	M	I	D	R	I	E	H	T	I	L	I	Z	E	T	I	R	D	I	V	F
A	L	M	S	D	E	Y	E	X	E	N	L	T	I	T	E	T	R	H	T	E	Z	A	L	I	Z	H	R	D	I	V	I	E
I	P	S	P	E	I	E	X	R	I	E	U	L	T	A	M	A	R	Y	R	Y	E	E	A	Z	E	T	D	I	V	I	N	T
R	I	P	I	N	R	E	P	E	R	U	D	U	L	T	I	M	Y	L	Y	L	E	R	E	H	T	H	E	V	I	N	E	S
P	O	C	N	E	I	R	E	E	N	D	N	D	U	L	T	I	M	E	T	E	L	Y	R	E	H	E	I	R	N	E	D	E
O	T	E	C	N	E	I	R	I	E	N	A	N	D	U	L	T	I	L	A	T	Y	R	E	A	E	I	R	D	E	D	E	S
O	R	T	E	C	N	P	R	O	G	A	N	A	N	D	U	L	T	I	M	A	T	E	L	E	I	R	D	I	V	E	S	T
G	P	O	P	O	C	O	P	G	O	N	O	I	T	C	E	F	R	E	P	D	P	L	Y	R	E	D	O	N	A	S	T	I
O	R	P	O	T	E	T	O	P	R	O	G	R	E	S	S	T	O	W	A	R	D	P	F	E	C	T	I	O	N	A	N	D
E	O	R	P	O	T	R	P	G	O	E	R	E	S	S	T	O	W	A	R	D	P	E	R	F	E	C	T	I	O	N	D	U
R	G	O	R	P	O	P	R	R	G	S	E	S	S	T	O	W	D	R	D	P	E	R	F	E	C	T	N	O	N	A	N	L

Finish

December 15–21

The Family: A Proclamation to the World

“The Family Is Central to the Creator’s Plan”

Instructions: Using the Across and Down clues, write the correct words in the numbered grid below. Hint: all of the words in the crossword come from the scripture below.

The Family Proclamation, paragraph 7, Beginning with the sentence, “The family is ordained of God.”

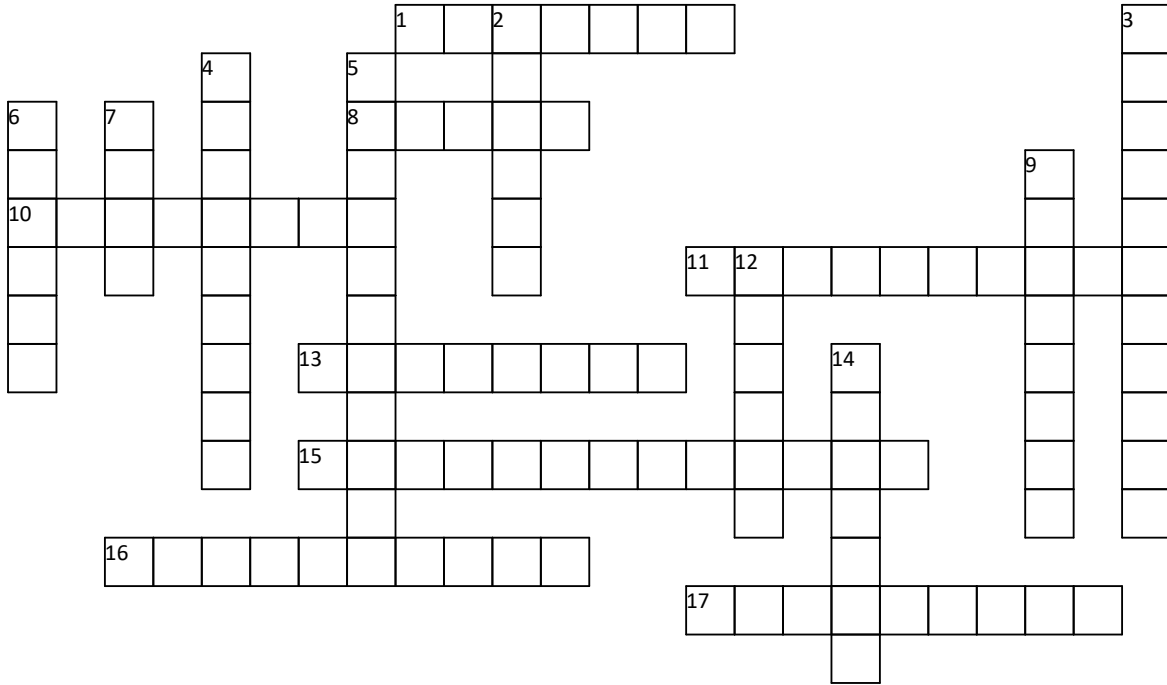

ACROSS

1. provide with nourishment
8. having the same quantity, value, or measure as another
10. the state of being a husband and wife voluntarily joined for life
11. the process of adjusting or conforming to new conditions
13. the quality of being faithful
15. a characteristic that covers all the attributes of God; describes a person who is Godly or Godlike
16. a deep awareness of and sympathy for another's suffering
17. ideas or principles taught by an authority

DOWN

2. bring up and care for a child until they are fully grown
3. worthy of or requiring trust; held accountable
4. caused by law or conscience to follow a certain course
5. the condition of being essential or indispensable
6. parents and children as a group
7. activity involving mental or physical effort done in order to achieve a purpose or result
9. human offspring (son or daughter) of any age
12. of, from, or like God
14. regard highly; think much of

December 22–28

Christmas

The Matchless Gift of God’s Divine Son

Word Angles

Instructions: Find the bold words from the scripture. Each word path may run north, east, south, or west, may make one right-angled turn, and may cross another word path. A few words may make no right angle turn at all.

The Living Christ, Paragraph 3

He **instituted** the **sacrament** as a **reminder** of His **great atoning sacrifice**. He was **arrested** and **condemned** on **spurious charges**, **convicted** to **satisfy** a **mob**, and **sentenced** to die on Calvary’s **cross**. He gave His **life** to **atone** for the **sins** of all **mankind**. His was a great **vicarious gift** in **behalf** of all who would **ever** live upon the **earth**.

D	J	R	S	A	C	R	A	D	E	T	S	L	F	P	C
N	E	G	O	D	E	N	M	E	L	F	E	A	R	Y	U
P	J	W	I	S	Q	S	E	D	P	D	R	H	E	E	E
S	K	G	W	A	T	I	N	N	V	E	R	E	M	O	N
T	A	C	I	C	S	N	T	O	U	E	A	B	I	E	O
A	A	O	F	R	I	F	I	C	E	R	E	D	N	A	T
E	X	N	P	M	H	E	N	C	E	D	M	S	S	O	A
R	G	V	Q	H	N	T	O	X	C	E	Q	U	U	R	B
F	N	I	D	E	T	N	Y	F	H	A	U	M	O	C	T
L	Y	C	L	S	U	E	I	S	A	R	T	H	I	R	A
D	E	T	R	N	T	S	S	I	R	C	D	N	R	L	U
M	O	B	G	N	I	N	U	T	G	P	O	I	U	P	S
D	Y	S	E	R	T	O	O	A	E	S	E	K	H	R	D
B	C	S	F	E	S	T	I	S	I	V	F	N	K	M	V
V	Z	S	I	V	N	A	R	A	C	I	V	A	K	O	G
M	X	D	L	E	I	P	L	G	I	F	T	M	I	C	E

Knight Moves - Find a Word

Instructions: Start with any letter in the puzzle to see if it’s the beginning of a word. To get to the second letter, jump two squares in any direction except diagonally, and then one square in a different direction. Your path will look like a capital L. Only one route through the puzzle will make a word. Write the letters of the word you discover in the blanks below as you jump through the squares:

1 2 3 4 5 6 7 8

Now can you find this word in the following hymn?

O Little Town of Bethlehem

r	l	m
i		o
c	p	a

Christmas Play

By Arie Van De Graaff

This Christmas play has a special message for the audience. To solve the puzzle and learn the message, start with person P. Notice that person E is wearing the same hat.

Write *P* and *E* in the first two spaces. Then find who has something in common with person E. Keep going until you have used all the letters.



December 22–28

Christmas

The Matchless Gift of God's Divine Son



Letterbox Puzzle

Instructions: Find the hidden word in the puzzle below by crossing out all letters that occur twice or more. Capitalized and lowercase letters count as unique letters for this puzzle. The letters left over will form a word. Write down the left over letters like you would read a book, from left to right and top to bottom. Then find the hidden word in the scripture or phrase below and circle it.

The Living Christ, Paragraph 2

He walked the roads of Palestine, healing the sick, causing the blind to see, and raising the dead. He taught the truths of eternity, the reality of our premortal existence, the purpose of our life on earth, and the potential for the sons and daughters of God in the life to come.

Write the hidden word:

H	M	P	h	A	e
X	u	c	Z	N	a
b	N	Q	u	L	W
c	P	b	E	I	E
E	A	†	n	†	Z
h	G	W	X	M	Q

Mystery Picture Graph

Instructions: Find the mystery picture below by plotting and connecting the points of each line on the coordinate graph. Connect all the points in Line 1, stop, pick up your pencil, and then connect all the points in Line 2, and so on for the rest of the lines. The dot for the first (X,Y) coordinate pair on Line 1 has been placed for you.

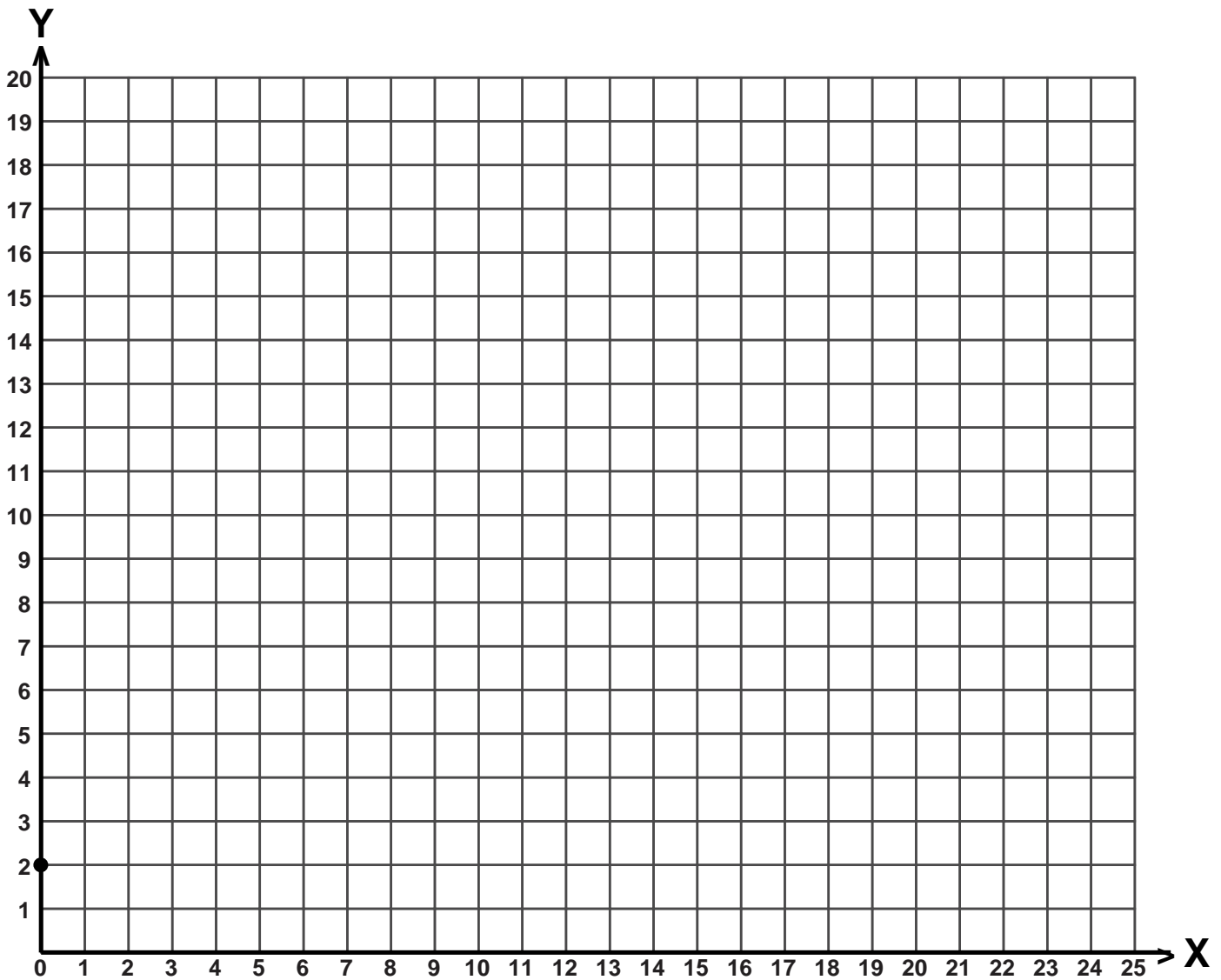

Line 1	(0, 2)	(13, 0)	(23, 2)	(22, 10)	(13, 15)	(1, 12)	(0, 2)	Line 2	(6, 13)	(6, 1)	Line 3	(7, 13)
(7, 1)	Line 4	(13, 15)	(13, 0)	Line 5	(17, 12)	(17, 1)	Line 6	(19, 12)	(18, 1)	Line 7	(18, 12)	(24, 12)
(22, 13)	(23, 15)	(19, 14)	(18, 15)	(19, 16)	(17, 19)	(13, 16)	(13, 20)	(12, 18)	(12, 16)	(13, 15)	Line 8	(13, 20)
(11, 20)	(9, 19)	(9, 18)	(8, 20)	(7, 19)	(6, 20)	(7, 18)	(7, 15)	(12, 15)	Line 9	(7, 15)	(10, 14)	Line 10
(13, 15)	(16, 16)	(18, 18)	Line 11	(7, 16)	(5, 15)	(6, 13)	Line 12	(5, 15)	(2, 17)	(3, 15)	(0, 15)	(6, 13)
Line 13	(18, 12)	(19, 14)	(18, 13)	(17, 13)	(16, 14)	(18, 15)	Line 14	(12, 15)	(9, 17)	(7, 17)		

December 22–28

Christmas

The Matchless Gift of God's Divine Son

Cryptogram

Instructions: Each letter on the top stands for a letter in the alphabet. Solve the encrypted phrase by matching each letter on top to a letter in the alphabet on the bottom. Use the key to help you remember what the letters stand for so you can crack the code.

P	R	O	L	F	M	H	S	J	C	G	W	T	X	I	V	A	U	N	Z	Q	D	E	K	Y	B
A	B	C	D	E	F	G	H	I	J	K	L	M	N	O	P	Q	R	S	T	U	V	W	X	Y	Z

G W O H M G W D O K G M , M G W D O E W ,

Q S V M G W G C A W C E M G W L C B D V .

G O H L Q Y O H M G W A Q M G M G Q M

D W Q V H M C G Q A A O S W H H O S M G O H

D O E W Q S V W M W B S Q D D O E W O S M G W

L C B D V M C J C F W . K C V Z W M G Q S X W V

E C B M G W F Q M J G D W H H K O E M C E G O H

V O P O S W H C S . M G W D O P O S K

J G B O H M , A Q B Q K B Q A G 1 4



As we commemorate the birth of Jesus Christ two millennia ago, we offer our testimony of the reality of His matchless life and the infinite virtue of His great atoning sacrifice. (The Living Christ, Paragraph 1)

December 22–28

Christmas

The Matchless Gift of God's Divine Son

All Heavenly Father's children will have the chance to **hear** the gospel.

Come, Follow Me 2025 Manual

