

September 29–October 5

## Doctrine and Covenants 109–110

“It Is Thy House, a Place of Thy Holiness”

### Reverse Word Search

Instructions: Instead of looking for words in a grid, place the bold words in the scripture in the empty word search puzzle. The words may be forwards, backwards, up, down, or diagonally. The start letter of the words have been placed in the grid to get you started.

#### Doctrine and Covenants 110:2-3

We saw the **Lord standing** upon the breastwork of the **pulpit**, before us; and under his **feet** was a **paved** work of pure **gold**, in color like **amber**. His **eyes** were as a **flame** of **fire**; the **hair** of his head was **white** like the pure **snow**; his **countenance shone** above the **brightness** of the **sun**; and his **voice** was as the **sound** of the **rushing** of great **waters**, even the voice of **Jehovah**, saying:

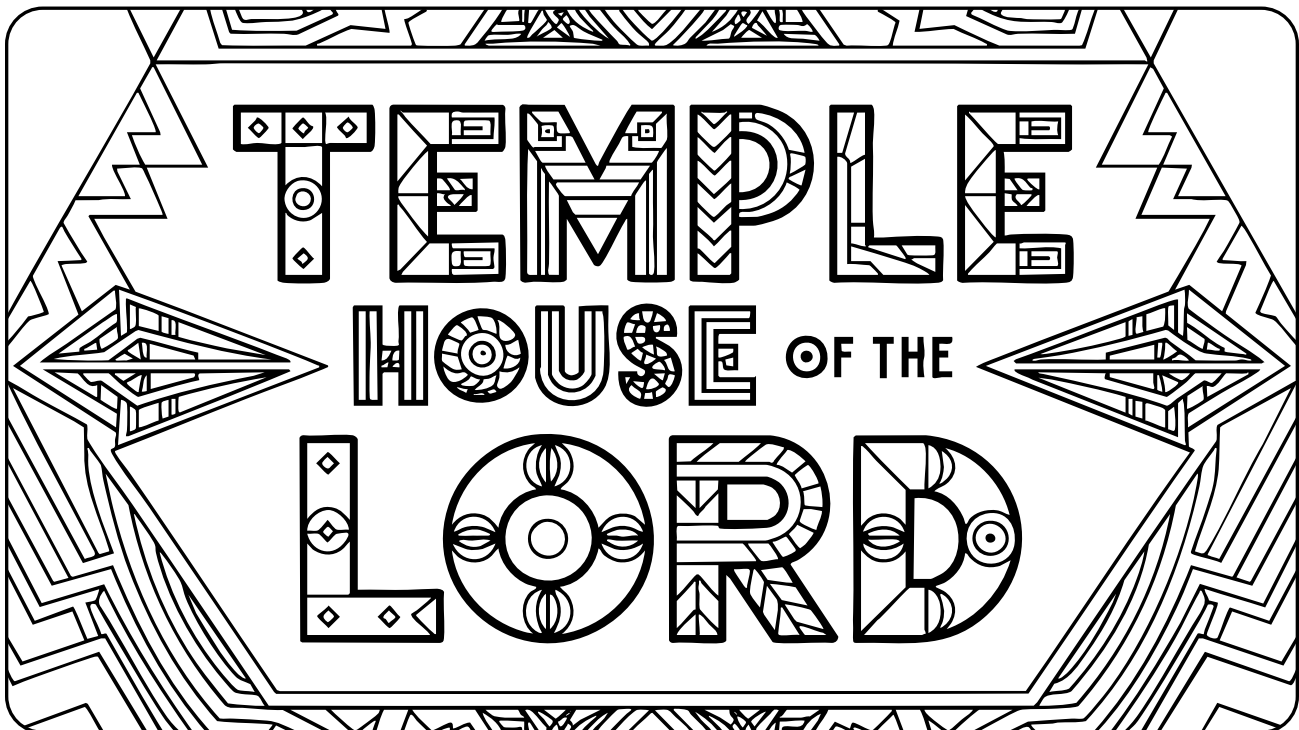
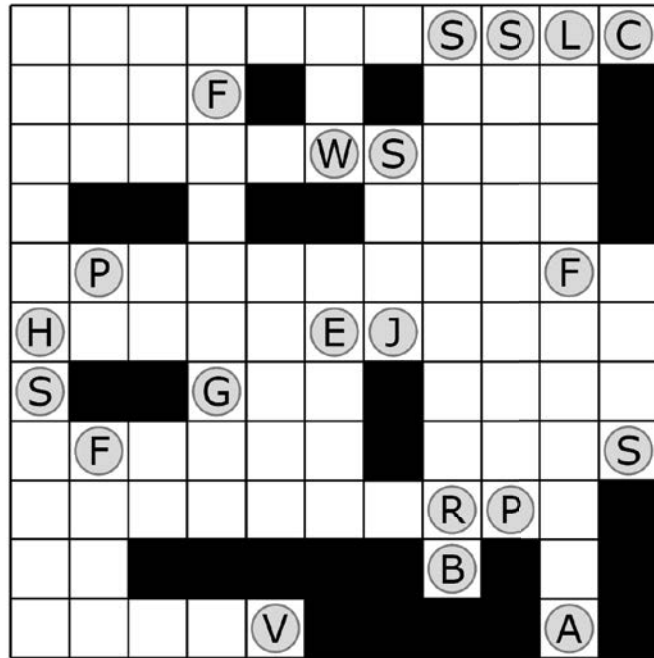

# Find the Differences

By Arie Van De Graaff

Kirtland, Ohio, was where the first temple was built after the gospel was restored. See if you can find 10 differences between these two pictures of neighbors walking outside the temple.

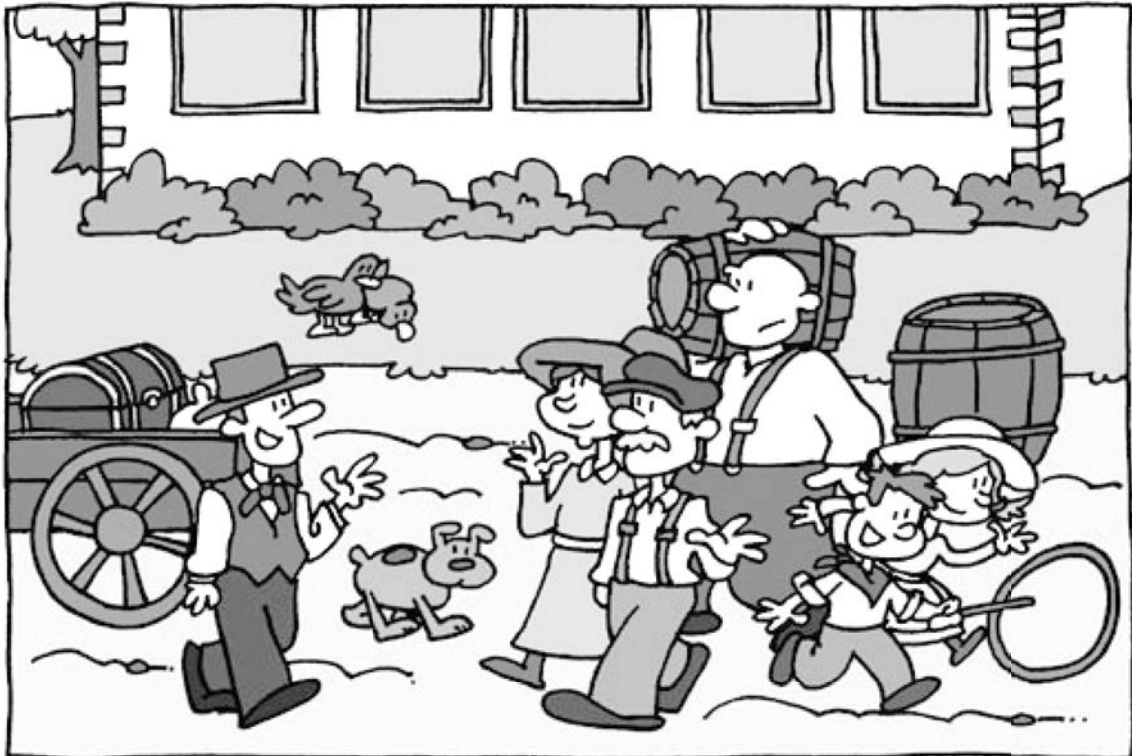
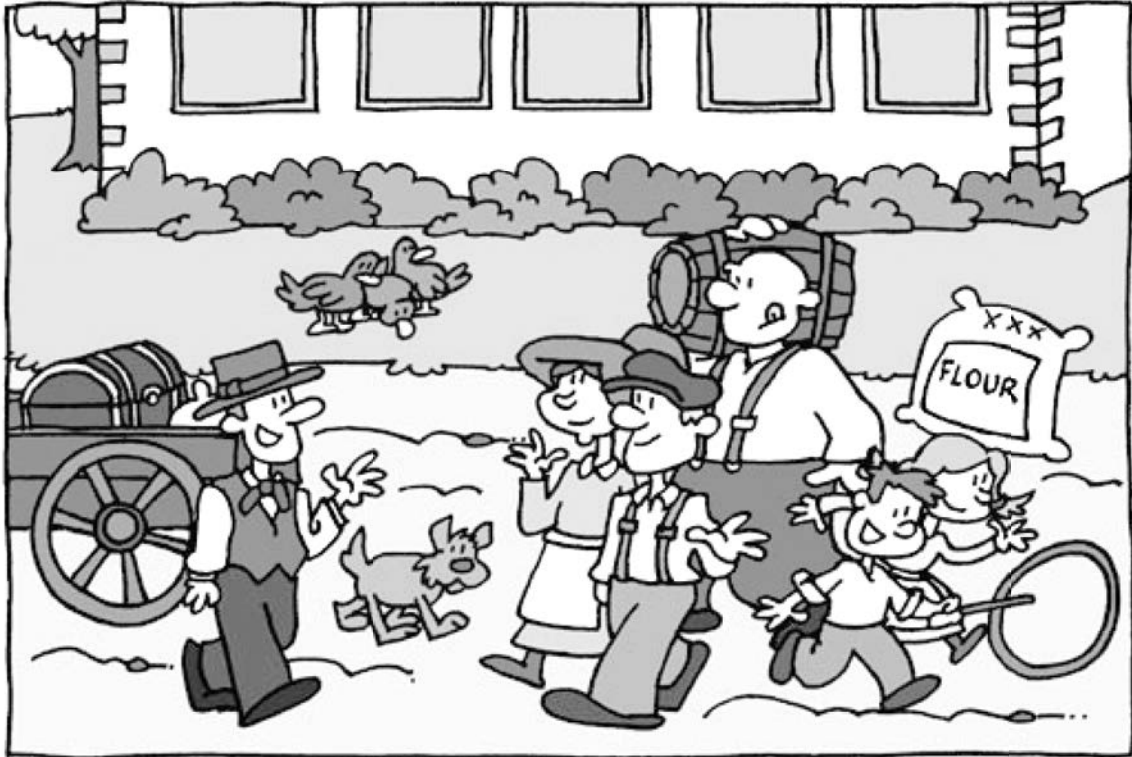



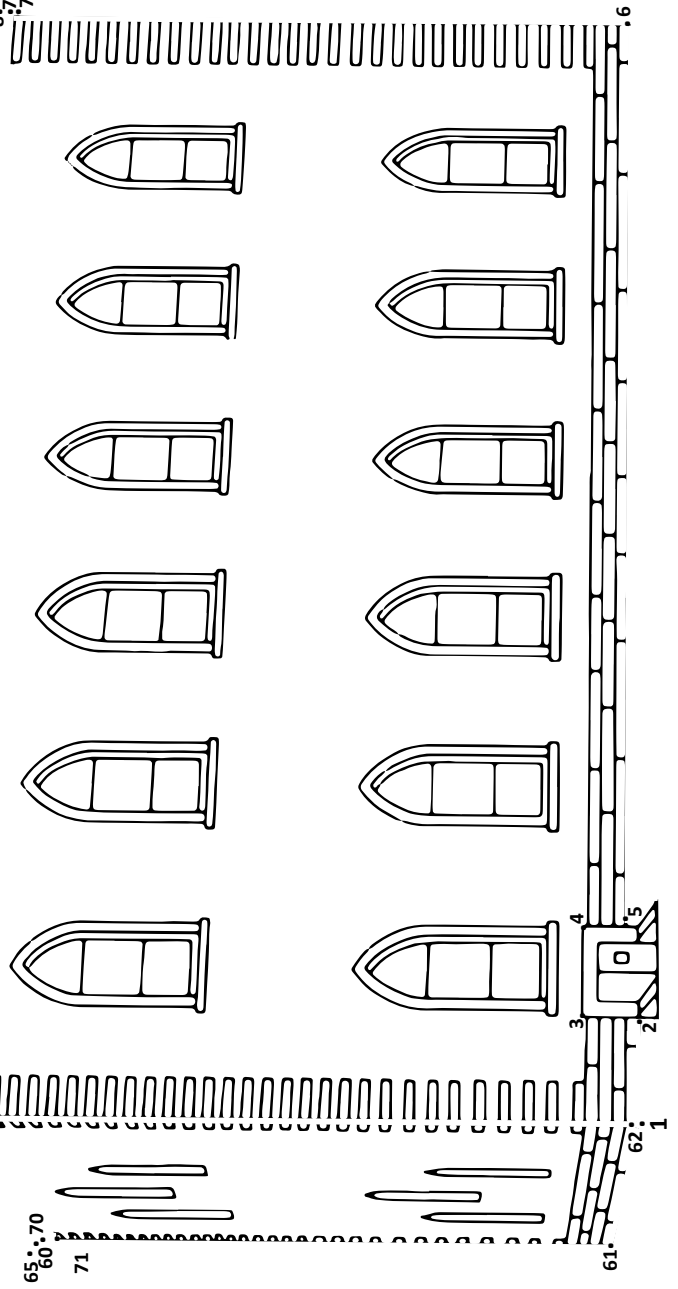
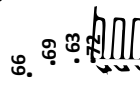
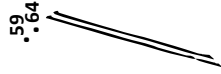
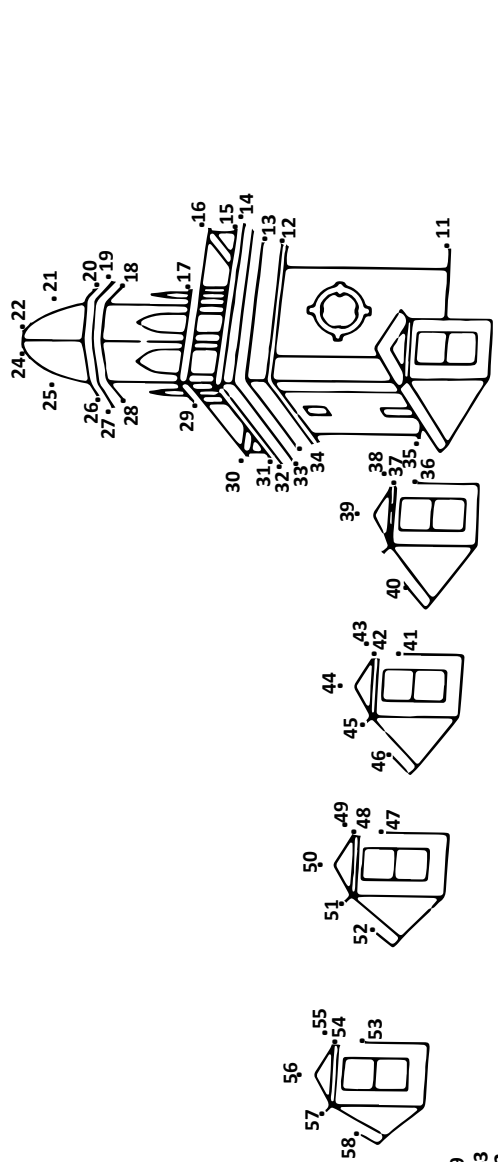
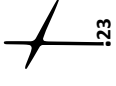

# Turning Our Hearts

The Savior wants us to turn our hearts to our ancestors. Can you help these children through the maze so they can find their grandparents?

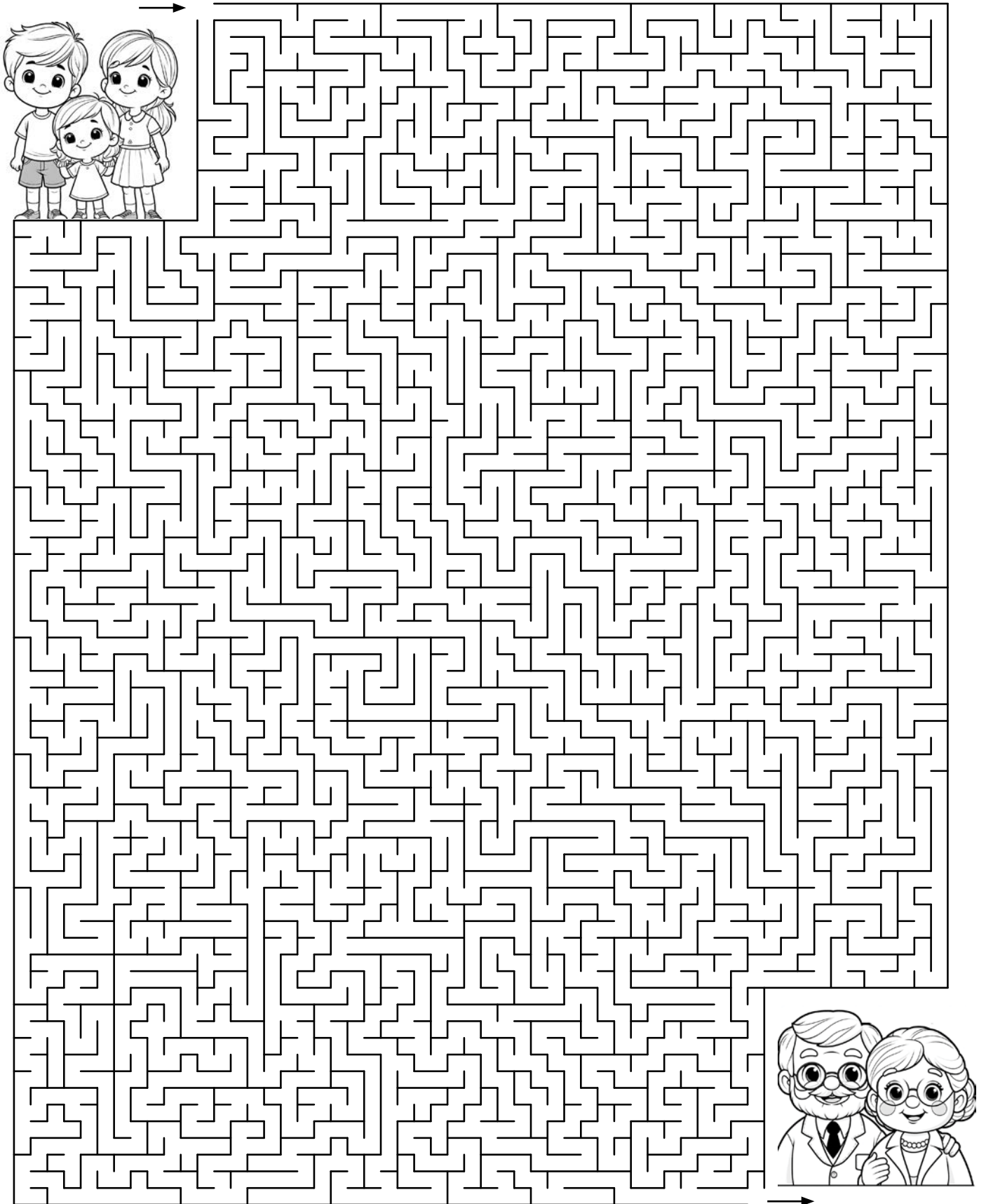

September 29–October 5

## Doctrine and Covenants 109–110

“It Is Thy House, a Place of Thy Holiness”

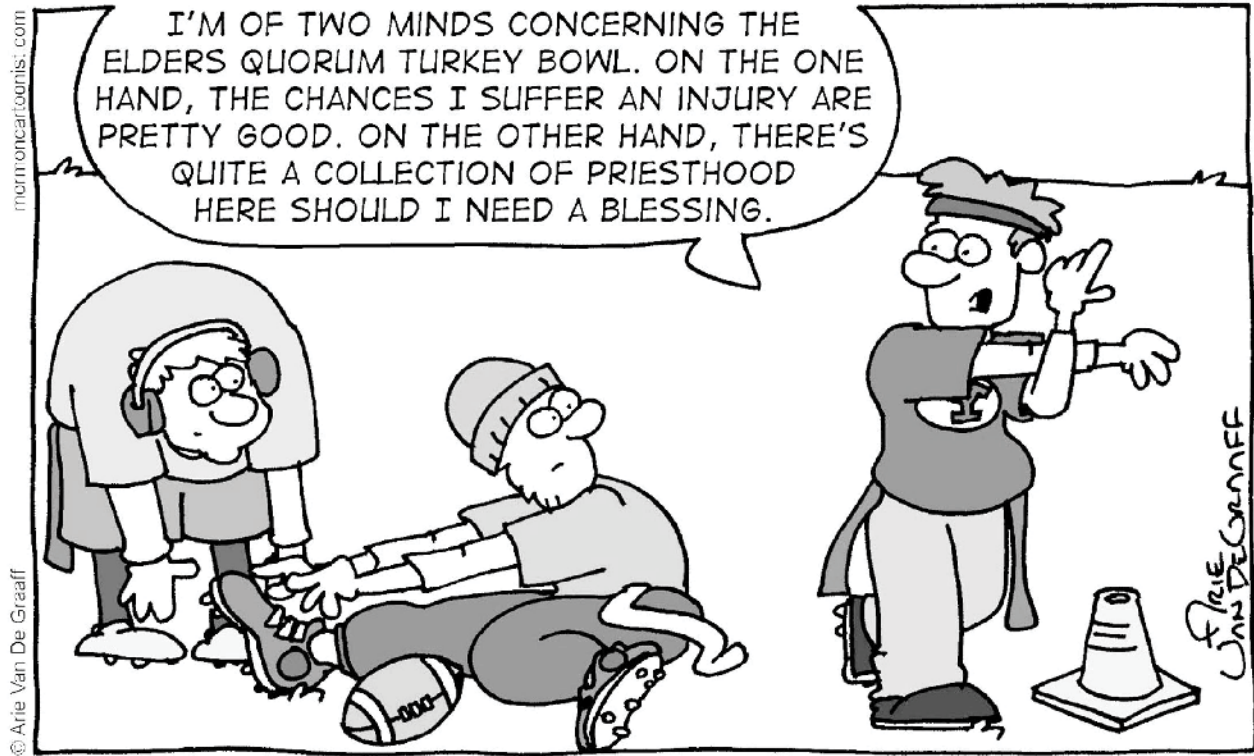

### Letterbox Puzzle

Instructions: Find the hidden word in the puzzle below by crossing out all letters that occur twice or more. Capitalized and lowercase letters count as unique letters for this puzzle. The letters left over will form a word. Write down the left over letters like you would read a book, from left to right and top to bottom. Then find the hidden word in the scripture or phrase below and circle it.

#### Doctrine and Covenants 109:12–13

That thy glory may rest down upon thy people, and upon this thy house, which we now dedicate to thee, that it may be sanctified and consecrated to be holy, and that thy holy presence may be continually in this house; And that all people who shall enter upon the threshold of the Lord's house may feel thy power, and feel constrained to acknowledge that thou hast sanctified it, and that it is thy house, a place of thy holiness.

Write the hidden word:

---

e	L	Z	L	h	H
B	n	N	q	j	q
O	e	U	p	K	s
n	D	N	g	j	J
w	h	B	Z	J	g
w	D	p	E	K	D